



**2017
POWERSPORTS
PRODUCTS**



**STREET
OFF-ROAD
SNOW
WATER**



SUPERIOR AIRFLOW. SUPERIOR PERFORMANCE.®



2017 POWERSPORTS

TABLE OF CONTENTS

Over the last 48 years, K&N® has cemented its place within the performance aftermarket industry. K&N® prides itself in its strong ties with multiple race series, dozens of shows, as well as hundreds of sponsored top racers and test riders. Across the United States, and abroad, K&N's commitment to quality and performance is exemplified day in and day out as K&N® products are proven in real world conditions. Come see first-hand how K&N® filtration products can benefit you and your vehicle at any one of the hundreds of shows and events listed on our website at:

www.knfilters.com/news/events.aspx

FOLLOW US AT:



KNFILTERS.COM

PROUD MEMBER SINCE 1979:



PROUD MEMBER:



K&N® PRODUCT LISTINGS

American V-Twin Air & Oil Filter Product Listings	71
Motorcycle Air & Oil Filter Product Listings	88
ATV Air & Oil Filter Product Listings	239
Specialty Air Filter and Filter Wrap Product Listings	271

AMERICAN V-TWIN

Performance Air Intake Systems*	10
High-Flow Air Filters™	16

STREET

RK Series Intake Systems*	20
Cruiser and Touring Air and Oil Filters	21
Scooter Air and Oil Filters	23
Sportbike Air and Oil Filters	24
Race-Spec Racing Air Filters	25

OFF-ROAD

Off-Road Air and Oil Filters	28
Motocross Xstream® Series Air Filters and Performance Oil Filters	29
Minibike Air Filters	30
Dirt Track Air Cleaners	31
ATV / UTV Air and Oil Filters	32
Side by Side Air and Oil Filters	34
ATV / Side by Side Aircharger® Intake Systems*	36

WATERCRAFT / SNOW

Watercraft Flame Arrestors	40
Watercraft Oil Filters	43
Snowmobile Air and Oil Filters	44

SPECIALTY / ACCESSORIES

Specialty and Racing Air Filters	48
Air Filter Wraps	49
Vent Breathers	50
Karting Air Filters	52

HAULER HORSEPOWER

Automotive High-Flow Intake Systems*	56
Automotive Air and Oil Filters	60
Commercial Grade Heavy Duty Air and Oil Filters	64

APPAREL / SIGNAGE

K&N® Apparel	67
Merchandising / Signage	68

ADDITIONAL INFORMATION

Cleaning Instructions and Supplies	294
------------------------------------	-----

*See page 175 for specifications regarding emissions standards and CARB regulations.

The following are Trademarks and/or Registered trademarks of K&N Engineering, Inc.: K&N, the K&N Logo, Aircharger, Drycharger, Filtercharger, FIPK, FIPK Generation 2, KNFILTERS.COM, KNPOWERSPORTS.COM, Performance Gold, Performance Silver, Precharger, Recharger, Stubstack, Typhoon, Xstream, the Xstream logo, Custom 66 Series, Powerlid, 57i, Wrench-Off Oil Filters, the Wrench-Off Oil Filter logo, the Wrench-Off Welded Nut on Canister Logo, High-Flow Air Filters, Power Kleen and the K&N Warranty medallions. K&N protects its marks and other legal rights against infringers.

K&N® IN 1969

WHERE IT ALL BEGAN

Ken Johnson and Norm McDonald make up the “K” and the “N” in K&N®. Ken and Norm were avid motorcycle racers who entered the aftermarket in the 1960’s with a line of motorcycle handlebars. While promoting their handlebars, Ken and Norm began experimenting with different air filter designs to combat the frustrations of the air filter technology of the day.

The problem dirt riders encountered with the paper filters used was that dirt would build up on the paper and block the flow of air to the carburetor. In addition, these paper filters were nearly impossible to clean and would usually have to be discarded after every race.

The most successful design they found consisted of layers of cotton gauze sandwiched between wire mesh. Unlike dry paper elements, they coated the cotton media with oil to act as a tacking agent to help trap dirt particles. This new technology allowed air to pass through, while still capturing dirt particles that could harm their engines.

In 1969 K&N® began production of oiled cotton gauze air filters and The World’s Best Air Filter™ was born.

Ken, Dale, and Norm



Early manufacturing facility



Norm McDonald - Acton, CA 1960

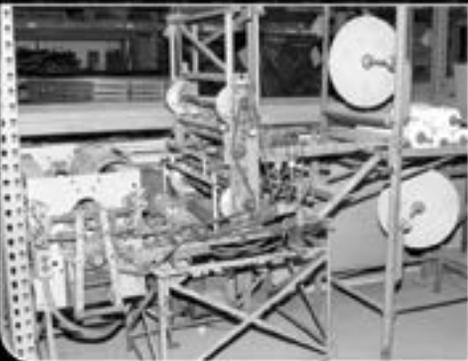

K&N's first media pleater "Plinky"



"King" Kenny Roberts - San Jose Mile 1972



Early air filter manufacturing

K&N® TODAY

THE PERFORMANCE AIR FILTER STANDARD

K&N® Truck and Trailer



As the originator and world leader of performance air filters, it is important to also be a leader in testing air filtration products. K&N® strives to provide a proven filtration system through our in-house test facilities. We believe our filter media provides the proper balance of airflow, protection and durability. We have advanced testing facilities that include filtration test labs, dynamometers, flowbenches, a MAF sensor test system, and many other testing machines. We put our products through extensive testing to ensure they are worthy of the name K&N®.

K&N® also employs a full staff of engineers and product designers working with the latest computer software to engineer every air filter and intake system we make. We even design and build most of the tooling and much of the machinery used to manufacture K&N® High-Flow Air Filters. With three machine shops on site, K&N® employs advanced equipment and machinery to ensure that our products are built to last. When you buy a K&N®, you can be certain we use everything we have learned to make sure our products perform their very best.



Product warehousing and processing



Automated pleating machines



Dynamometer testing



CNC filter mold fabrication



Dust retention testing

HIGH-FLOW AIR FILTERS™

DESIGNED TO INCREASE HORSEPOWER

K&N® delivers the same high-flow technology in every filter we manufacture. Headquartered in Riverside, California, K&N® Engineering, Inc. has been the world leader in performance filter technology since 1969. Creating a high-flow, washable and reusable air filter put K&N® on the map.

- *Designed to provide low restriction resulting in increased airflow and high performance*
- *Pleated media provides a large filtration area offering long service intervals*
- *Most are pre-oiled and ready to ride*
- *10-year/million mile limited warranty*
for details, visit knfilters.com/warranty



WASHABLE
REUSABLE
PERFORMANCE®



for details, visit
knfilters.com/warranty

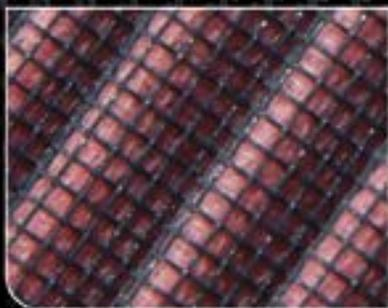

**HIGH-FLOW WASHABLE
COTTON MEDIA**



**APPLICATION-SPECIFIC
SEALING BEAD**



**ZINC COATED TOP PLATES
WHERE APPLICABLE**



**DESIGNED TO FIT INTO OE
AIR FILTER ASSEMBLIES**



**XSTREAM® SERIES AIR
FILTER INSTALLED**



**SPECIALTY CLAMP-ON
AIR FILTERS INSTALLED**



1

Oiled premium cotton gauze helps maintain high airflow and excellent filtration

- Thousands of microscopic cotton threads absorb special air filter oil, creating a powerful filter media
- Pleated design provides a large surface area for high dirt capacity and long service intervals
- Epoxy coated aluminum screen mesh protects filter media

2

OE style mounting tabs *(where applicable)*

3

One-piece seamless sealing bead ensures a precise fit

- Custom molded, application-specific air filter frame allows for easy installation *(where applicable)*

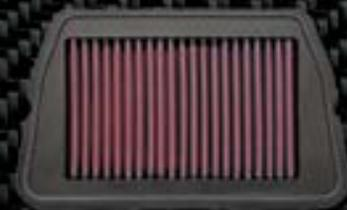

K&N® High-Flow Cotton Air Filter

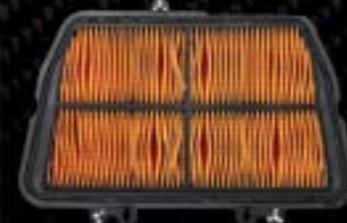

Common OE Paper Air Filter

WRENCH-OFF® OIL FILTERS

HIGH-FLOW PERFORMANCE FILTER MEDIA

K&N® delivers a premium oil filter built to withstand the high demands of racing conditions. Our oil filters are designed with a high-flow synthetic media that is engineered to provide high flow rates and outstanding filtration. They are ideal for use with premium synthetic and traditional oils. In order to ease maintenance, a 17mm nut has been welded to the top to allow for easy removal, especially in tight, hard to reach spaces. A heavy duty canister provides a high-burst strength while also adding extra protection from debris and rocks in off-road environments. K&N® oil filters deliver performance and confidence!

- Specially designed for today's synthetic and extended service motor oils
- Sturdy 17mm hex nut eases removal in hard to reach areas
- Ideal for hard to reach oil filters, do-it-yourself oil changes, high performance engines, and track or race applications
- One-Year Limited Warranty
for details, visit knfilters.com/warranty

Use of a K&N Performance Oil Filter will NOT void factory warranty.



CARTRIDGE-STYLE OIL FILTERS ALSO AVAILABLE



17MM WRENCH NUT EASES REMOVAL*



SYNTHETIC MEDIA FOR HIGH FLOW RATES



PRE-DRILLED FOR SAFETY WIRE ATTACHMENT*



PRE-LUBED BASE SEAL FOR QUICK INSTALLATION*



KN-171C INSTALLED



KN-170 REMOVAL

*Where applicable



- 1** Welded 17mm hex nut for easy wrench-off® removal*
 - Pre-drilled for safety-wire attachment during racing
- 2** Heavy duty canister construction provides a high burst strength and extra protection from debris and rocks in off-road conditions
 - Most available in black or chrome finish
- 3** Tension spring
- 4** Part number specific bypass/pressure relief valve*
- 5** Specially designed to be compatible with premium synthetic, blended and traditional motor oils
 - Premium synthetic media provides outstanding filtration while allowing for high-flow rates
- 6** Anti-drainback valve prevents dry starts*
- 7** Heavy duty baseplate with leakproof double-rolled seal
- 8** Pre-lubed base seal or gasket* for easy no-mess installation

*Where applicable



K&N® High-Flow Synthetic Media



Common Cellulose OE Replacement





AMERICAN V-TWIN

HIGH-FLOW AIR FILTERS™

- The original High-Flow Air Filter™ invented by K&N®
- Designed to provide low restriction, resulting in increased airflow and high performance
- Pleated media provides a large filtration area, delivering high capacity and long service intervals
- Specifically designed to fit into your OE air filter assembly
- Pre-oiled and ready to ride



WASHABLE
REUSABLE
PERFORMANCE®

for details, visit
knfilters.com/warranty

PERFORMANCE INTAKE SYSTEMS†

- Guaranteed to increase horsepower
- Better engine sound and power you can feel
- Replaces OE air filter assembly
- Multiple styles to choose from
- Developed around an oversized K&N® High-Flow Air Filter™
- 10-year/million mile limited warranty

for details, visit knfilters.com/warranty



†

SOME INTAKE SYSTEMS ARE NOT LEGAL FOR SALE OR USE ON ANY POLLUTION CONTROLLED MOTOR VEHICLE IN CALIFORNIA OR STATES ADOPTING CALIFORNIA EMISSION PROCEDURES.

See knfilters.com for CARB status on each part for a specific vehicle

See knfilters.com for specifications regarding emissions standards and CARB regulations.

WRENCH-OFF® OIL FILTERS

- Specially designed to be compatible with synthetic, blended and traditional motor oils
- Premium synthetic media provides outstanding filtration and high-flow rates
- Sturdy 17mm hex nut eases removal in hard to reach areas
- Heavy duty canister provides a high burst strength and extra protection
- Most Available in Black or Chrome Finish
- One-Year Limited Warranty

for details, visit knfilters.com/warranty



AIRCHARGER® INTAKE SYSTEMS*

GUARANTEED TO INCREASE HORSEPOWER!

Now K&N® is proud to introduce yet another way to get a guaranteed increase in horsepower for your bike!

- *Guaranteed to increase horsepower*
- *Cast aluminum high-performance intake tube*
- *Integrated internal velocity stack*
- *Built-in breathers replace external OE breathers*
- *K&N® high-flow cotton air filter provides outstanding performance and protection*
- *Available in black satin and silver satin finish*

 Aircharger® Intake System Installed



Fits:

- **'08-'16 Harley-Davidson®**
*Touring models *without lower fairings*
- **'01-'15 Harley-Davidson®**
Dyna® / Softail® models

**GUARANTEED TO INCREASE
HORSEPOWER**

* NOT LEGAL FOR SALE OR USE ON ANY POLLUTION CONTROLLED MOTOR VEHICLE IN CALIFORNIA OR STATES ADOPTING CALIFORNIA EMISSION PROCEDURES.

See knfilters.com for CARB status on each part for a specific vehicle

See knfilters.com for specifications regarding emissions standards and CARB regulations.

Dyna® and Softail® are trademarks of Harley-Davidson®. Harley-Davidson® is a registered trademark of H-D Michigan, Inc.



STREET METAL™ - SHAKER INTAKE SYSTEMS* GUARANTEED TO INCREASE HORSEPOWER!

Shaker Intake System Installed



Fits:

- '08-'16 Harley-Davidson®
Touring models *without lower fairings
- '01-'15 Harley-Davidson®
Dyna® / Softail® models



The new Street Metal™ line of intake systems from K&N® features nostalgic good looks and improved power and torque delivery for your bike.

- *Guaranteed to increase horsepower*
- *Cast-aluminum high-volume intake with exaggerated sanded fins*
- *Oversized K&N® High-Flow Air Filter™ for excellent filtration and long service intervals*
- *Built-in dyno-tuned velocity-stack directs airflow to the throttle body*
- *Mounts with integrated breather system*
- *Available in black satin and satin silver finish*



* NOT LEGAL FOR SALE OR USE ON ANY POLLUTION CONTROLLED MOTOR VEHICLE IN CALIFORNIA OR STATES ADOPTING CALIFORNIA EMISSION PROCEDURES.

See knfilters.com for CARB status on each part for a specific vehicle

See knfilters.com for specifications regarding emissions standards and CARB regulations.

Dyna® and Softail® are trademarks of Harley-Davidson®. Harley-Davidson® is a registered trademark of H-D Michigan, Inc.

STREET METAL™ - SIDEDRAFT INTAKE SYSTEMS*

GUARANTEED TO INCREASE HORSEPOWER!

With over 45 years of experience, K&N® continues providing custom good looks while increasing performance to your Harley-Davidson® motorcycle.

- *Guaranteed to increase horsepower*
- *Cast-aluminum high-volume intake with exaggerated sanded fins*
- *Oversized K&N® High-Flow Air Filter™ for excellent filtration and long service intervals*
- *Built-in dyno-tuned velocity-stack directs airflow to the throttle body*
- *Mounts with integrated breather system*
- *Available in black satin and satin silver finish*



Fits:

- **'08-'16 Harley-Davidson®
Touring models** *without lower fairings
- **'01-'15 Harley-Davidson®
Dyna® / Softail® models**



**GUARANTEED TO INCREASE
HORSEPOWER**



* **NOT LEGAL FOR SALE OR USE ON ANY POLLUTION CONTROLLED MOTOR VEHICLE IN CALIFORNIA OR STATES ADOPTING CALIFORNIA EMISSION PROCEDURES.**

See knfilters.com for CARB status on each part for a specific vehicle

See knfilters.com for specifications regarding emissions standards and CARB regulations. for details, visit

Dyna® and Softail® are trademarks of Harley-Davidson®. Harley-Davidson® is a registered trademark of H-D Michigan, Inc.

PERFORMANCE AIR INTAKE SYSTEMS* GUARANTEED TO INCREASE HORSEPOWER!



RK SERIES INTAKE SYSTEMS*

Fits neatly behind OE air cleaner cover to maintain a stock appearance while providing low restriction, increased performance and long service intervals.



for details, visit
knfilters.com/warranty



AIRCHARGER® INTAKE SYSTEMS*

Featuring a mandrel-bent aluminum intake tube, these intakes provide an aggressive appearance and an increase in horsepower that you can feel!



STREET METAL™ INTAKE SYSTEMS*

A high-quality aluminum cover and oversized K&N® High-Flow Air Filter™ provides custom good looks while increasing performance and service intervals.



MULTIPLE STYLES AVAILABLE



* SOME INTAKE SYSTEMS ARE NOT LEGAL FOR SALE OR USE ON ANY POLLUTION CONTROLLED MOTOR VEHICLE IN CALIFORNIA OR STATES ADOPTING CALIFORNIA EMISSION PROCEDURES.

See knfilters.com for CARB status on each part for a specific vehicle

AMERICAN
V-TWIN

STREET

OFF-ROAD

WATERCRAFT/SNOW

SPECIALTY/ACCESSORIES

HAULER HORSEPOWER

APPAREL/SIGNAGE

K&N® PRODUCT LISTINGS

AIR FILTER ASSEMBLIES FOR AMERICAN V-TWINS

PERFORMANCE AIR INTAKE SYSTEMS



MODEL	YEARS	CAST W/ FINS AIRCHARGER SILVER	CAST W/ FINS AIRCHARGER BLACK	SMOOTH AIRCHARGER BRIGHT/CHROME	SMOOTH AIRCHARGER BLACK	STREET SHAKER SILVER	STREET SHAKER BLACK	STREET SIDEDRAFT SILVER	STREET SIDEDRAFT BLACK
SPORTSTER® MODELS									
Sportster®	15-16	•	•	63-1126P	63-1126	•	•	•	•
Sportster®	07-14	•	•	57-1126P	57-1126	•	•	•	•
DYNA® MODELS									
Dyna®	2017	63-1137S	63-1137	63-1125P†	63-1125†	RK-3950S	RK-3950	RK-3953S	RK-3953
Dyna®	01-15	63-1137S	63-1137	57-1125P†	57-1125†	RK-3950S	RK-3950	RK-3953S	RK-3953
SOFTAIL® MODELS									
Softail®	2017	63-1134S	63-1134	63-1122P†	63-1122†	RK-3951S	RK-3951	RK-3952S	RK-3952
Softail®	13-15	63-1137S	63-1137	63-1125P†	63-1125†	RK-3950S	RK-3950	RK-3953S	RK-3953
Softail®	01-12	63-1137S	63-1137	63-1125P†	63-1125†	RK-3950S	RK-3950	RK-3953S	RK-3953
TOURING MODELS									
Milwaukee-Eight™	2017	63-1139S	63-1139	63-1138C	63-1138	•	•	•	•
Touring	14-16	63-1134S	63-1134	63-1122P†	63-1122†	RK-3951S	RK-3951	RK-3952S	RK-3952
Touring	08-13	63-1134S	63-1134	57-1122P†	57-1122†	RK-3951S	RK-3951	RK-3952S	RK-3952
W/Lower Fairings	08-16	•	•	63-1131P	63-1131	RK-3951S	RK-3951	RK-3952S	RK-3952
Touring	01-07	63-1137S	63-1137	57-1125P†	57-1125†	RK-3950S	RK-3950	RK-3953S	RK-3953

* Fits 1999-2000 models † with Rushmore™ Air Cleaner ‡ Does not fit with lower fairings

This application guide is an abbreviated listing for the primary models of Harley-Davidson® motorcycles. For the most complete and up-to-date application guide for each specific model, visit knfilters.com.

HIGH-FLOW AIR FILTERS™

HARLEY-DAVIDSON® MOTORCYCLES	YEAR	H-D OEM #	OEM REPLACEMENT	SE OEM #	SCREAMIN' EAGLE®
TOURING MODELS					
Touring Milwaukee-Eight™	2017	29400212	HD-1717	•	•
Touring (Exc. listed below)	14-16	2940045	HD-1614	2924408	HD-0818
CVO™ w/ Ventilator Intake	10-16	2967009	HD-0910	2967009	HD-0910
Touring (Exc. listed below)	08-13	2963308	HD-1508	2924408	HD-0818
Touring (Exc. listed below)	99-07	2946199	HD-1499	2944299	HD-0800
Touring F/I	99-01	2946199	HD-1499	2944299	HD-0800
Touring F/I	95-98	2929195	HD-1395	2905589	HD-0600
SOFTAIL® MODELS					
Softail®	99-16	2946199	HD-1499	2944299	HD-0800
Softtail Slim® / Crossbones™	08-15	2931408	HD-1611	2944299	HD-0800
Softail®	90-99	2925991	HD-1390	2905589	HD-0600
DYNA® / FXR MODELS					
Dyna® Blackline® / Street Bob®	11-17	2931408	HD-1611	2944299	HD-0800
Dyna®	08-16	2919108	HD-9608	2938508	HD-0808
Dyna®	99-07	2946199	HD-1499	2944299	HD-0800
Dyna® F/I	99-01	2946299	HD-8899	2944299	HD-0800
FXR / Dyna®	90-99	2925991	HD-1390	2905589	HD-0600
FXR	86-89	2925986	HD-2086	•	•
SPORTSTER® MODELS					
XL	14-17	29400015	HD-1212	2904404	HD-0900
Seventy-Two®	12-13	29400015	HD-1212	2904404	HD-0900
XL	04-13	2933104	HD-8834	2904404	HD-0900
XL	88-03	2903688	HD-1388	•	•
OTHER MODELS					
VRSC V-ROD®	02-16	2943701	HD-1102	•	•
XR1200™	08-12	2937708	HD-1208	•	•

Dyna®, Sportster®, Softail®, Rushmore™, Street Bob®, CVO™, Milwaukee-Eight™, Softail Slim®, Crossbones™, Seventy-Two®, V-Rod®, XR1200™, and Electra Glide® are trademarks of Harley-Davidson®. Harley-Davidson® is a registered trademark of H-D Michigan, Inc.

HIGH-FLOW AIR FILTERS™ FOR AMERICAN V-TWINS

AMERICAN
V-TWIN



STREET HAMMER CHROME	STREET HAMMER BLACK	HAMMER LARGE CAP. CHROME	HAMMER LARGE CAP. BLACK	STREET FLARE CHROME	STREET FLARE BLACK	FLARE CHROME LARGE CAP.	FLARE BLACK LARGE CAP.	RK-SERIES STANDARD CAPACITY	RK-SERIES LARGE CAPACITY
RK-3945	RK-3945B	•	•	•	•	•	•	RK-3943	•
RK-3944	RK-3944B	•	•	•	•	•	•	RK-3929	•
RK-3933	RK-3933B	RK-3933X	RK-3933XB	RK-3932	RK-3932B	RK-3932X	RK-3932XB	•	•
RK-3933	RK-3933B	RK-3933X	RK-3933XB	RK-3932	RK-3932B	RK-3932X	RK-3932XB	RK-3931*	•
•	•	•	•	•	•	•	•	RK-3941†	•
RK-3933	RK-3933B	RK-3933X	RK-3933XB	RK-3932	RK-3932B	RK-3932X	RK-3932XB	RK-3942	•
RK-3933	RK-3933B	RK-3933X	RK-3933XB	RK-3932	RK-3932B	RK-3932X	RK-3932XB	RK-3909-1*	RK-3910-1*
RK-3954	RK-3954B	•	•	RK-3949	RK-3949B	•	•	•	•
RK-3946	RK-3946B	RK-3946X	RK-3946XB	RK-3947	RK-3947B	RK-3947X	RK-3947XB	RK-3941†	•
RK-3946	RK-3946B	RK-3946X	RK-3946XB	RK-3947	RK-3947B	RK-3947X	RK-3947XB	RK-3930	RK-3930X
RK-3946	RK-3946B	RK-3946X	RK-3946XB	RK-3947	RK-3947B	RK-3947X	RK-3947XB	RK-3930	RK-3930X
RK-3933	RK-3933B	RK-3933X	RK-3933XB	RK-3932	RK-3932B	RK-3932X	RK-3932XB	RK-3909-1*	RK-3910-1*

STREET

OFF-ROAD

WATERCRAFT/SNOW

SPECIALTY/ACCESSORIES

HAULER HORSEPOWER

APPAREL/SIGNAGE

K&N® PRODUCT LISTINGS

This application guide is an abbreviated listing for the primary models of Harley-Davidson® motorcycles. For the most complete and up-to-date application guide for each specific model, visit knfilters.com.

HIGH-FLOW AIR FILTERS™

INDIAN	YEAR	OEM #	OEM REPLACEMENT
Chief Classic/Chieftan/Roadmaster	14-17	5813976	PL-1814
Scout	15-16	7082024	PL-1115
Chief	09-13	N71500000	E-3290
VICTORY	YEAR	OEM #	OEM REPLACEMENT
Hammer/Highball/Kingpin/Vegas	08-14	5813074	PL-1608
V92SC/Hammer/Kingpin/Touring/Vegas	00-07	7080858	PL-1500
V92C	98-99	7080695	PL-1598
S&S	SIZE	OEM #	OEM REPLACEMENT
"D" Teardrop Housing	2-1/16"	•	E-3224
Teardrop Shaped Housing	2-3/16"	•	E-3225
"E" & "G" Housing	2-1/2"	•	E-3226

WRENCH-OFF® PERFORMANCE OIL FILTERS

TOURING MODELS	YEAR	BLACK	CHROME
FLHT Electra Glide®	1999	KN-170	KN-170C
FLH	85-98	KN-170	KN-170C
FLH	82-84	KN-172B	KN-172C
FLT	80-98	KN-170	KN-170C
All Other Touring	99-16	KN-171B	KN-171C
SOFTAIL® MODELS	YEAR	BLACK	CHROME
All Softail®	00-16	KN-171B	KN-171C
All Softail®	80-99	KN-170	KN-170C
SPORTSTER® MODELS	YEAR	BLACK	CHROME
All XL	84(end)-16	KN-170B	KN-170C
All XL	80-84(beg.)	KN-172B	KN-172C

DYNA® / FXL MODELS	YEAR	BLACK	CHROME
All Dyna®	99-16	KN-171B	KN-171C
All Dyna®	91-98	KN-173B	KN-173C
All FXR	82-92	KN-170	KN-171C
FXE, FXEF, FXDWG	82-85	KN-172B	KN-172C
FXB Sturgis	80, 82	KN-173B	KN-173C
OTHER MODELS	YEAR	BLACK	CHROME
VRSC V-ROD	02-16	KN-174B	KN-174C
XR1200	08-12	KN-170	KN-170C
VICTORY MODELS	YEAR	BLACK	CHROME
All Victory	02-16	KN-198	OE#2540086

HIGH-FLOW AIR FILTERS™ FOR AMERICAN V-TWINS

AIR FILTERS FOR SPORTSTER® MODELS

OE REPLACEMENT AIR FILTER FOR 2004-15 SPORTSTER®

DESCRIPTION	PART#
Replaces OE# 29331-04 For 2004-2013 Sportster® Except XL-1200V 72	HD-8834
Replaces OE# 294000-15 For 2012-2016 XL-1200V Sportster® 72 & 2014-2015 Sportster®	HD-1212

PART NUMBER
HD-8834



PART NUMBER
HD-1212



REPLACEMENT AIR FILTER FOR 2004-15 SPORTSTER® SCREAMIN' EAGLE®

DESCRIPTION	PART#	DRYCHARGER®
Replaces Screamin' Eagle® # 29442-99E	HD-0800	HD-0800DK
Replaces Screamin' Eagle® # 29044-04B	HD-0900	•

PART NUMBER
HD-0900



AIR FILTERS FOR DYNA® MODELS

OE REPLACEMENT AIR FILTER FOR 2008-16 DYNA® MODELS

DESCRIPTION	PART#
Replaces OE# 29191-08 Except 2013+ Dyna Street Bob	HD-9608

PART NUMBER
HD-9608



REPLACEMENT AIR FILTER FOR 2008-15 DYNA® SCREAMIN' EAGLE®

DESCRIPTION	PART#
Replaces Screamin' Eagle® # 29385-08	HD-0808

PART NUMBER
HD-0808



AIR FILTERS FOR TWIN CAM® AND SOFTAIL® MODELS

REPLACEMENT AIR FILTER FOR 1999-07 TWIN CAM® & 2008-15 SOFTAIL® MODELS

DESCRIPTION	PART#
Replaces OE# 29461-99 (most 99-07 Twin Cam® and 99-15 Softail® models)	HD-1499
Replaces OE# 29462-99 (99-01 F/I Twin Cam® models)	HD-8899
Replaces OE# 29314-08 (Cross Bones™/Blackline®/Softail Slim®)	HD-1611

PART NUMBER
HD-1499



PART NUMBER
HD-1611



PART NUMBER
HD-8899



REPLACEMENT AIR FILTER (TAPERED) FOR MOST 1999-07 TWIN CAM® SCREAMIN' EAGLE®

DESCRIPTION	PART#	DRYCHARGER®
Replaces Screamin' Eagle® part numbers 29442-99A, 29442-99B, 29442-99C, 29442-99D & 29442-99E	HD-0800	HD-0800DK

PART NUMBER
HD-0800



HIGH-FLOW AIR FILTERS™ - FOR S&S CARBS

FOR S&S MODELS	O.D.	HEIGHT	PART#
"E" & "G" teardrop housing	6"	2-1/2"	E-3226
Teardrop shaped housing	6"	2-3/16"	E-3225
"D" teardrop housing	6"	2-1/16"	E-3224

PART NUMBER
E-3226



CVO™, Milwaukee-Eight™, Screamin' Eagle®, V-ROD®, and XR1200™ are trademarks of Harley-Davidson®. Harley-Davidson® is a registered trademark of H-D Michigan, Inc.

HIGH-FLOW AIR FILTERS™ FOR AMERICAN V-TWINS

AIR FILTERS FOR TOURING MODELS

OE REPLACEMENT AIR FILTER FOR 2008-2017 TOURING MODELS

DESCRIPTION	PART#
Replaces OE# 29633-08 For 2008-2013 Touring Models	HD-1508
Replaces OE# 294000-45 For 2014-2016 Touring Models	HD-1614
Replaces OE# and 2010-2016 CVO™ # 29670-09	HD-0910
Replaces OE# 29400212 For 2017 Milwaukee-Eight™	HD-1717

PART NUMBER
HD-1508



PART NUMBER
HD-1614



PART NUMBER
HD-0910



REPLACEMENT AIR FILTER FOR 2008-16 TOURING MODELS SCREAMIN' EAGLE®

DESCRIPTION	PART#	DRYCHARGER®
Replaces Screamin' Eagle® # 29244-08	HD-0818	HD-0800DK
Replaces Screamin' Eagle® Ventilator # 29670-09	HD-0910	•
Replaces Screamin' Eagle® # 2941308 For 2014-16 58mm TBFI Element	HD-0918	•

PART NUMBER
HD-0818



PART NUMBER
HD-0918



PART NUMBER
HD-1717



Patent pending

AIR FILTERS FOR EVO MODELS

OE REPLACEMENT AIR FILTER FOR 1990-99 EVO MODELS

DESCRIPTION	PART#
Replaces OE# 2925991A & 2933096	HD-1390
• Fits models with and with out vent lines	

PART NUMBER
HD-1390



REPLACEMENT AIR FILTER (STRAIGHT ELEMENT) FOR EVO SCREAMIN' EAGLE®

DESCRIPTION	PART#
2" height (Replaces Screamin' Eagle® # 29055-89)	HD-0600

PART NUMBER
HD-0600



AIR FILTERS FOR OTHER HARLEY-DAVIDSON® MODELS

OE REPLACEMENT AIR FILTER FOR 2002-16 V-ROD®

DESCRIPTION	PART#
Replaces OE# 29437-01	HD-1102

PART NUMBER
HD-1102



OE REPLACEMENT AIR FILTER FOR 2008-12 HARLEY-DAVIDSON® XR1200™

DESCRIPTION	PART#
Replaces OE# 29377-08	HD-1208

PART NUMBER
HD-1208



OE REPLACEMENT AIR FILTER FOR 2015 HARLEY-DAVIDSON® XG500/750 STREET

DESCRIPTION	PART#
Replaces OE# 29400078	HD-4915

PART NUMBER
HD-4915



AMERICAN
V-TWIN

STREET

OFF-ROAD

WATERCRAFT/SNOW

SPECIALTY/ACCESSORIES

HAULER HORSEPOWER

APPAREL/SIGNAGE

K&N® PRODUCT LISTINGS

CVO™, Milwaukee-Eight™, Screamin' Eagle®, V-ROD®, and XR1200™ are trademarks of Harley-Davidson®. Harley-Davidson® is a registered trademark of H-D Michigan, Inc.

Parts Updated Daily at KNFILTERS.COM or Call 800-858-3333



STREET PERFORMANCE

HIGH-FLOW AIR FILTERS™

- The original High-Flow Air Filter™ invented by K&N®
- Designed to provide low restriction, resulting in increased airflow and high performance
- Pleated media provides a large filtration area, delivering high capacity and long service intervals
- Specifically designed to fit into your OE air filter assembly for simple installation
- Pre-oiled and ready to ride



for details, visit
knfilters.com/warranty

**WASHABLE
REUSABLE
PERFORMANCE®**

WRENCH-OFF® OIL FILTERS

- Specially designed to be compatible with premium synthetic, blended and traditional motor oils
- Premium synthetic media provides outstanding filtration while allowing for high-flow rates
- Sturdy 17mm hex nut eases removal in hard to reach areas
- Heavy-duty canister and construction provides a high burst strength and extra protection
- Most available in black or chrome finish
- One-Year Limited Warranty

for details, visit knfilters.com/warranty



OTHER PRODUCTS FOR STREET BIKES

RK SERIES INTAKE SYSTEMS

– FOR METRIC CRUISERS –



SOME INTAKE SYSTEMS ARE NOT LEGAL FOR SALE OR USE ON ANY POLLUTION CONTROLLED MOTOR VEHICLE IN CALIFORNIA OR STATES ADOPTING CALIFORNIA EMISSION PROCEDURES.

See knfilters.com for CARB status on each part for a specific vehicle

PURPOSE-BUILT RACE-SPEC AIR FILTERS

– FOR PERFORMANCE TRACK BIKES –



See knfilters.com for specifications regarding emissions standards and CARB regulations.

LEGAL IN CALIFORNIA ONLY FOR RACING VEHICLES WHICH MAY NEVER BE USED, REGISTERED OR LICENSED FOR USE UPON A HIGHWAY.

See knfilters.com for CARB status on each part for a specific vehicle

RK INTAKE SYSTEMS[†] FOR METRIC CRUISERS

Developed to provide increased horsepower while delivering custom good looks and long service intervals to your metric cruiser.

- Oversized K&N[®] original High-Flow Air Filter™
- Pleated design provides high airflow
- High-quality custom aluminum air cleaner cover
- Powder-coated billet aluminum backing plate*
- Dyno-tuned velocity stacks*
- Spacers and mounting hardware included
- 10-year/million mile limited warranty

for details, visit knfilters.com/warranty

*where applicable



RK-3940 installed on a 2014 Yamaha XVS950 Bolt

SOME INTAKE SYSTEMS ARE NOT LEGAL FOR SALE OR USE ON ANY POLLUTION CONTROLLED MOTOR VEHICLE IN CALIFORNIA OR STATES ADOPTING CALIFORNIA EMISSION PROCEDURES.

See knfilters.com for CARB status on each part for a specific vehicle

See knfilters.com for specifications regarding emissions standards and CARB regulations.

2014¹ / 2015-16² YAMAHA XVS950 BOLT / VBOLT R-SPEC



RK-3940
CONTRAST CUT



RK-3906 - SMOOTH
RK-3916 - GROOVED
RK-3926 - FLAMED

RK SERIES COMPLETE INTAKE SYSTEMS FOR METRIC CRUISERS

HONDA	YEAR	MIRRORED DESIGN	GROOVED DESIGN	FLAMED DESIGN	CONTRAST CUT	EST. HP GAIN [†]
VTX1800	02-08	RK-3906 ¹	RK-3916 ¹	RK-3926 ¹	•	TBA
KAWASAKI						
VN2000 Vulcan	04-07	RK-3908 ¹	RK-3918 ¹	RK-3928 ¹	•	TBA
YAMAHA						
XVS950 Bolt / Bolt R-Spec	2014	•	•	•	RK-3940 ¹	+ 7 hp [†]
XVS950 Bolt / Bolt R-Spec	15-16	•	•	•	RK-3940 ²	+ 7 hp [†]
XV1600 RoadStar	99-03	RK-3905-1 ¹	RK-3915-1 ¹	RK-3925-1 ¹	•	TBA
XV1700 RoadStar	04-12	RK-3905-1 ¹	RK-3915-1 ¹	RK-3925-1 ¹	•	TBA

1) 50 state street legal 2) Not legal for sale or use on any pollution controlled motor vehicle in California or states adopting California emission procedures.
[†]Estimated horsepower and torque gains based on specific or similar vehicle dynamometer tests. Results will vary. Visit knfilters.com for specifications regarding emissions standards and CARB regulations.

HIGH-FLOW AIR FILTERS™ FOR METRIC CRUISERS

Honda GL1800 Goldwing F6B



Perfect for 2-up rides on your cruiser with filled saddle bags, a long life High-Flow Air Filter™ delivers improved performance for the life of your motorcycle.

- Pleated media provides a large filtration area offering long service intervals
- Designed to provide increased horsepower and torque
- Fits into your OE Air Filter assembly



METRIC CRUISER OE REPLACEMENT FILTERS - See page 88 for additional product listings

HONDA	YEAR	AIR FILTER	OIL FILTER
CMX250 Rebel	96-16	HA-2596	•
CTX700	14-15	HA-7012	KN-204*
VT600C/CD Shadow	99-07	HA-6199	KN-303*
VT750 Shadow	98-07	HA-7500	KN-303*
VT750 Shadow Aero/Spirit	04-09	HA-7504	KN-204*
VT750 Shadow	10-15	HA-7504	KN-204*
VT1100C Shadow	89-07	HA-1187	KN-303*
VTX1300C, R, S, T	03-09	HA-1330	KN-204*
VTX1300CR, S, T, X Fury	10-16	HA-1310	KN-204*
VTX1800C, F, N, R, S, T	02-08	HA-1802	KN-204*
GL1800 Gold Wing/F6B	13-16	HA-1801	KN-204*
GL1800 Valkyrie/ABS	14-15	HA-1801	KN-204*
NC700J NM4	2016	HA-7012	•
KAWASAKI			
VN900 Vulcan Models	06-16	KA-9006	KN-303*
VN1500/1600 Vulcan	99-06	KA-1596	KN-204*
VN1500 Vulcan Classic	07-08	KA-1596	KN-303*
VN1600 Vulcan Classic/Nomad	04-08	KA-1603	KN-204*
VN1600 Vulcan Meanstreak	07-08	KA-1596	KN-303*
VN1600 Vulcan Models	07-08	KA-1603	KN-303*
VN1700 Vulcan Models	09-15	KA-1709	KN-303*
VN2000 Vulcan Models	04-06	KA-2008	KN-204*
VN2000 Vulcan Models	07-10	KA-2008	KN-303*
SUZUKI			
LS650 Savage	86-04	SU-6595	KN-137
Boulevard S40	05-16	SU-6595	•
Boulevard S50	05-09	SU-7086	KN-138*
VL800 Intruder	09-13	SU-8009	KN-138*

SUZUKI CONTINUED	YEAR	AIR FILTER	OIL FILTER
Boulevard C50	05-08	SU-8001	KN-138*
Boulevard C50	09-15	SU-8009	KN-138*
Boulevard C90	05-09	SU-1598	KN-138*
Boulevard M50	05-08	SU-8005	KN-138*
Boulevard M50	09-13	SU-8009	KN-138*
Boulevard M109R	06-15	SU-1806	KN-138*
VZR1800 Intruder	06-12	SU-1806	KN-138*
YAMAHA			
VMX1200 V-Max	96-07	YA-1285	KN-303*
VMX1700 V-Max	09-16	YA-1709	KN-303*
XV250 Rte 66/Virago/V-Star	88-16	YA-2588	KN-145
XVS650 Drag Star/V-Star	96-16	YA-6598	KN-145
XVS950 Bolt	14-16	YA-9514	KN-204*
XVS950/1300 V-Star	09-16	YA-1307	KN-204*
XVS1100 V-Star	99-09	YA-1199	KN-145
XVS13CA Stryker	11-16	YA-1307	KN-204*
XVZ1300 Royal Star Venture	02-13	YA-1399	KN-303*
XV1600 Roadstar	99-03	YA-1699	KN-303*
XV1700 RoadStar	04-14	YA-1704	KN-303*
XV1700 RoadStar Warrior	02-09	YA-1602	KN-303*
XV1900 Roadliner/Stratoliner	06-14	YA-1906	KN-303*
XV1900 Raider	08-16	YA-1906	KN-303*
TRIUMPH			
America	04-14	TB-8002	KN-204*
Speedmaster	04-14	TB-8002	KN-204*
Thunderbird	10-15	TB-1610	KN-204*
Rocket III	04-14	TB-2204	KN-204*

* Add C for Chrome

AMERICAN V-TWIN

STREET

OFF-ROAD

WATERCRAFT/SNOW

SPECIALTY/ACCESSORIES

HAULER HORSEPOWER

APPAREL/SIGNAGE

K&N® PRODUCT LISTINGS

HIGH-FLOW AIR FILTERS™ FOR TOURING

Ideal for long distance touring or commuting, installing a long-life High-Flow Air Filter™ delivers improved performance and extended service intervals for your motorcycle.

- Pleated media provides a large filtration area offering long service intervals
- Designed to provide increased horsepower and torque
- Fits into your OE air filter assembly



TOURING OE REPLACEMENT FILTERS - See page 88 for additional product listings

APRILIA	YEAR	AIR FILTER	OIL FILTER
Tuono R/Tuono R Factory	06-13	AL-1004	KN-152
BMW			
F650GS Dakar	01-07	BM-6501	KN-151
F700GS/F800GS/Adventure	06-15	BM-8006	KN-164
R1100/R1150	93-06	BM-0400	KN-163
R1200GS/R/RT	04-15	BM-1204	KN-164
R1200GS(Water Cooled)/RS/RT	13-15	BM-1113	KN-160
K1200R	05-07	BM-1205	KN-160
K1200S	05-08	BM-1205 ¹	KN-160
K1200LT	98-08	BM-1299	KN-163
K1300GT/R/S	09-15	BM-1205	KN-160
K1600GT/GTL	11-15	BM-1611	KN-164
BUELL			
Ulysses XB12X/T	06-10	BU-9003	KN-177
CAN-AM			
Spyder/RS 990	08-12	CM-9908	KN-564/559
Spyder RS/ST	10-16	CM-9910	•
Spyder RT	14-15	CM-1314	•
Spyder RT	10-12	CM-9910	KN-564/559
Spyder RT	10-13	CM-9910	KN-564
DUCATI			
Diavel	11-15	DU-1007	KN-153
Sport/GT1000/Hypermotard	08-15	DU-1006	KN-153
Multistrada 620/1000/1100	03-09	DU-1004	KN-153
Multistrada 1200/S/Touring	10-14	DU-1210	KN-153
GT1000/Sport 1000	08-10	DU-1006	KN-153
ST2/ST3/ST4/800SS/1000SS	97-07	DU-9098	KN-153
HONDA			
CTX700/NC700	12-16	HA-7012	KN-204*
CTX1300/ST1300	02-15	HA-1302	KN-204*
Deauville NT 700V	06-11	HA-7010	KN-204*
GL1800 Gold Wing	01-16	HA-1801	KN-204*
NSA 700 DN-01	08-10	HA-6708	KN-204*
XL1000 Varadero	03-10	HA-1003	KN-204*
VFR1200F / Crosstourer	10-15	HA-1110	KN-204*

KAWASAKI	YEAR	AIR FILTER	OIL FILTER
KLR650	87-15	KA-6589	KN-123
Versys/Z1000	11-16	KA-1111	KN-303*
ZG1400 Concours	08-14	KA-1406	KN-303*
KTM			
690 Duke	07-14	KT-6907	KN-155/157
950 Adventure/SMR	03-09	KT-9504	KN-158
990 Adventure/SMT/Supermoto	07-13	KT-9907	KN-158
1190 Adventure/1290 Super Duke	13-14	KT-1113	KN-158
POLARIS			
Slingshot 2.4L	2015-16	PL-2415	PS-7000
SUZUKI			
DL650 V-Strom	02-16	SU-1002	KN-138*
DL1000 V-Strom	14-15	SU-1014	KN-138*
GSX650F Bandit/S	05-13	SU-6505	KN-138*
GSF1200/1250/Bandit	06-13	SU-6505	KN-138*
GSX1300BK B-KING	07-12	SU-1348	KN-138*
TRIUMPH			
America/Spdmster 800/900	04-15	TB-8002	KN-204*
Bonneville/Scrambler/Thruxton	04-15	TB-9004	KN-204*
Rocket III	04-15	TB-2204	KN-204*
Sprint/Sprint GT	05-12	TB-1005	KN-204*
Thunderbird	10-15	TB-1610	KN-204*
Tiger	07-13	TB-1005	KN-204*
Tiger 800	11-15	TB-8011	KN-204*
Tiger Explorer 1200	12-15	TB-1212	KN-204*
Trophy SE	13-14	TB-1213	KN-204*
YAMAHA			
FZ6	07-09	YA-6004	KN-204*
FJ-09/MT09	14-16	YA-8514	KN-204*
FZ1/FZS1000 Fazer	01-05	YA-1001	KN-303*
FZ1/Fazer	06-15	YA-1006	KN-204*
FJR1300	01-16	YA-1301	KN-148
VMX1700 V-Max	09-12	YA-1709	KN-303*
XT1200Z Super Tenere	10-16	YA-1210	KN-204*
MT07	14-15	YA-6814	KN-204*

* Add C for Chrome 1) Requires two filters

HIGH-FLOW AIR FILTERS™ FOR SCOOTERS

Yoshimura R&D Honda MSX125 Grom



Whether commuting or cutting through traffic, a High-Flow Air Filter™ will give your scooter an easy to install increase in performance.

- Pleated media provides a large filtration area offering long service intervals
- Designed to provide low restriction and increased performance
- Washable & reusable, easy to maintain



SCOOTER AIR AND OIL FILTERS - Visit knfilters.com for additional product listings

KAWASAKI	CC	YEAR	AIR FILTER	OIL FILTER
Leonardo 125/150	125/150	96-05	•	KN-185
Scarabeo 150/200 Rotax	200	99-03	•	KN-185
BMW				
C600 Sport	647	12-15	BM-6012	•
C650GT	647	12-16	BM-6012	•
HONDA				
CHF60 Metropolitan	50	02-09	HA-0502	•
CN250 Helix	250	86-07	HA-2586	•
FJS/FSC600 Silver Wing	600	01-13	HA-6002	KN-204*
MSX125 Grom	125	13-16	HA-1313	•
NCH50 Metropolitan	50	13-15	HA-0513	•
NPS50 Ruckus	50	03-16	HA-0502	•
NSS300 Forza	300	14-16	HA-2714	KN-204*
PCX125/250	125	13-14	HA-1213	•
PS250 Big Ruckus	250	05-06	HA-2500-1	•
SH150i	150	01-12	HA-1510	•
SH125i/SH150i	150	13-15	HA-1513	•
SH300i	300	07-12	HA-3011	KN-204*
KYMCO				
MyRoad	700	11-12	•	KN-147
Downtown 200i/300i/350i	300	10-16	KY-2911	•
Xciting 500	500	05-09	•	KN-147
Xciting 500 Ri	500	08-12	•	KN-147
MBK				
125 Cityliner	125	07-11	•	KN-141
PEUGEOT				
Citystar	125	11-12	•	KN-185
Geo RS	125	07-09	•	KN-185
Sat RS	125	06-12	•	KN-185

SUZUKI	CC	YEAR	AIR FILTER	OIL FILTER
AN150 Burgman	150	95-00	•	KN-131
AN250 Burgman	250	99-04	SU-2599	KN-132
AN250 Burgman	250	05-07	•	KN-132
AN400 Burgman	400	99-06	SU-2599	KN-132
AN400 Burgman	400	07-15	SU-4007	KN-131
AN650 Burgman	650	03-10	SU-6303	KN-138
AN650 Burgman Executive	650	04-09	•	KN-138
FU150 Raider	150	04-10	SU-1506	•
UH200 Burgman	200	07-10	•	KN-131
YAMAHA				
CP250 Morphous	250	06-08	•	KN-132
Cygnus 125	125	02-04	YA-1202	•
Ray / Z	113	13-15	YA-1113	•
T135	135	06-10	YA-1306	•
XC125SR Cygnus X SR	125	04-07	YA-1202	•
XC200Z Riva	200	87-90	•	KN-145
XP500 T-Max	500	01-07	YA-5001	KN-147
XP500 T-Max	500	08-13	YA-5008	KN-147
XP500 T-Max Special	500	06-07	YA-5001	KN-147
XQ125 Maxster/Thunder	125	01-02	YA-2598	•
XQ150 Maxster/Thunder	150	01-02	YA-2598	•
YJ125 Vino	125	04-09	•	KN-143
YM150	150	1999	YA-2598	•
YP125 Majesty	125	98-05	YA-2598	•
YP125R X-Max	125	06-14	YA-2406	KN-141
YP180 Majesty	180	2006	YA-2598	•
YP250G Grand Majesty	250	04-07	•	KN-132
YP250 X-MAX	250	06-15	YA-2406	•
YP400 Majesty	400	04-13	•	KN-132
YW125 Zuma	125	09-15	YA-1209	•

AMERICAN V-TWIN

STREET

OFF-ROAD

WATERCRAFT/SNOW

SPECIALTY/ACCESSORIES

HAULER HORSEPOWER

APPAREL/SIGNAGE

K&N® PRODUCT LISTINGS

HIGH-FLOW AIR FILTERS™ FOR SPORTBIKES

Designed to provide low restriction for improved throttle response, horsepower, and torque.

- Washable pleated media provides a large filtration area offering long service intervals
- A great first step in your performance package
- Fits into your OE air filter assembly



SPORTBIKE OE REPLACEMENT FILTERS - See page 88 for additional product listings

APRILIA	YEAR	AIR FILTER	OIL FILTER	KAWASAKI CONTINUED	YEAR	AIR FILTER	OIL FILTER
RSV Mille/1000R/Factory	05-13	AL-1004	KN-152	ZX10R Ninja	2016	KA-1016	•
RSV4 R	09-13	AL-1010	KN-138*	Z1000/ZX1000 Ninja	11-16	KA-1111 ²	KN-303*
BMW				Z1000	10-11	KA-1010 ¹	KN-303*
S1000R/S1000RR	10-16	BM-1010	KN-160	ZX14R Ninja/ZZR1400	06-11	KA-1406	KN-303*
HP4	12-15	BM-1010	KN-160	KTM			
R nineT	14-15	BM-1204	KN-164	690 Duke/Duke R	14-16	KT-6912	KN-155
DUCATI				1190 RC8	08-14	KT-1108	KN-158
Scrambler 803	15-16	DU-8015	KN-153	SUZUKI			
Monster 696/796	10-14	DU-6908	KN-153	GSXR600/750	06-10	SU-7506	KN-138*
1198/R/S/Corse	10-11	DU-1007	KN-153	GSXR600/750	11-15	SU-7511	KN-138*
Street Fighter/848	08-15	DU-1007	KN-153	GSXR1000	05-08	SU-1005	KN-138*
899 Panigale	13-15	DU-1112	•	GSXR1000	09-15	SU-1009	KN-138*
1199 Panigale	12-15	DU-1112	KN-159	GSX1300R Hayabusa	08-15	SU-1308	KN-138*
Monster 1100	09-13	DU-6908	KN-153	GSX1300BK B-King	07-12	SU-1348	KN-138*
HARLEY-DAVIDSON®				TRIUMPH			
XR1200™ X/Sportster®	08-12	HD-1208	KN-170*	Daytona 675/Street Triple	06-12	TB-6706	KN-204*
HONDA				Daytona 675/Street Triple	13-14	TB-6713	KN-204*
CBR250R	11-13	HA-2511	KN-112	Speed Triple	05-10	TB-1005	KN-204*
CBR500R	13-15	HA-5013	KN-204*	Speed Triple	11-14	TB-1011	KN-204*
CBR600RR	07-16	HA-6007	KN-204*	YAMAHA			
CBR650F/ABS	14-16	HA-6414	KN-204*	FZ6	07-09	YA-6004	KN-204*
CB1000R	08-16	HA-1009	KN-204*	FZ6R/XJ6	09-16	YA-6009	KN-204*
CBF1000	12-13	HA-1009	KN-204*	FZ8	10-15	YA-1006	KN-204*
CBR1000RR	04-07	HA-1004	KN-204*	FZ-09	14-16	YA-8514	KN-204*
CBR1000RR	08-15	HA-1008	KN-204*	FZ1	06-15	YA-1006	KN-204*
KAWASAKI				SR400	14-15	YA-5008	•
EX250R Ninja	08-12	KA-2508	KN-401	YZF600R	97-07	YA-6096	KN-303*
EX300R Ninja	13-15	KA-2508	KN-303*	YZF R6	06-07	YA-6006	KN-204*
EX650R Ninja/ERGN	12-16	KA-6512	KN-303*	YZF R6	08-16	YA-6008	KN-204*
ZX6R Ninja	09-16	KA-6009	KN-303*	YZF R3	2015	YA-3215	KN-204*
ZX10R Ninja	08-10	KA-1008	KN-303*	YZF R1	07-08	YA-1007	KN-204*
ZX10R Ninja	11-15	KA-1011	KN-303*	YZF R1	09-14	YA-1009	KN-204*

* Add C for Chrome 1) Before VIN# ZRT00DE10765 2) After VIN# ZRT00DE010766

XR1200™ and Sportster® are trademarks of Harley-Davidson®. Harley-Davidson® is a registered trademark of H-D Michigan, Inc.

HIGH-FLOW AIR FILTERS™ FOR PERFORMANCE TRACK BIKES

Yoshimura Suzuki - Roger Lee Hayden



Purpose-built for racing and closed-course track bikes, RACE-SPEC air filters are designed to increase horsepower by delivering extremely low restriction.

- Developed to increase horsepower and acceleration for the race track
- Specially pleated two-ply cotton race filter media
- Fewer pleats than standard K&N® replacement air filters
- Fits directly in OE air box
- Washable and reusable
- K&N® One Year Limited Warranty
for details, visit knfilters.com/warranty

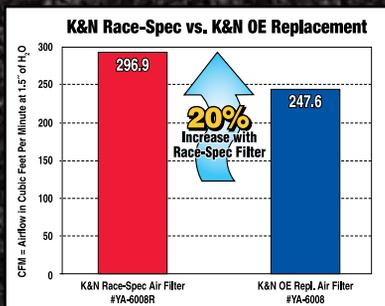

Airflow rates shown are estimates based on individual tests of specific air filters. Results will vary.

**Fuel management modifications
WILL be necessary.**

**These filters are designed for
closed-course competition use only.**

*** LEGAL IN CALIFORNIA ONLY FOR RACING VEHICLES WHICH MAY NEVER BE USED, REGISTERED OR LICENSED FOR USE UPON A HIGHWAY.**

See knfilters.com for CARB status on each part for a specific vehicle

See knfilters.com for specifications regarding emissions standards and CARB regulations.



**TWO-LAYER COTTON MEDIA
WITH FEWER PLEATS**



**SPECIFIC SEALING
BEAD**

RACE-SPEC HIGH-FLOW AIR FILTERS™

APRILIA	YEAR	PART#	KAWASAKI	YEAR	PART#
RSV4 R/Tuono V4	09-15	AL-1010R	ZX6R Ninja	07-08	KA-6007R
BMW			ZX6R Ninja	09-16	KA-6009R
S1000RR	10-16	BM-1010R	ZX10R Ninja	08-10	KA-1008R
HP4	12-15	BM-1010R	ZX10R Ninja	11-15	KA-1011R
DUCATI			SUZUKI		
848	08-13	DU-1007R	GSXR600/750	06-10	SU-7506R
899/1199 Panigale	12-16	DU-1112R	GSXR600/750	11-16	SU-7511R
1098/1198R/S/SP	07-11	DU-1007R	GSXR1000	05-08	SU-1005R
HONDA			GSXR1000	09-16	SU-1009R
CBR600RR	07-16	HA-6007R	GSX1300R	08-16	SU-1308R
CBR1000RR	04-07	HA-1004R	YAMAHA		
CBR1000RR	08-15	HA-1008R	YZF R6	08-16	YA-6008R
			YZF R1	09-14	YA-1009R

Parts Updated Daily at KNFILTERS.COM or Call 800-858-3333

AMERICAN V-TWIN

STREET

OFF-ROAD

WATERCRAFT/SNOW

SPECIALTY/ACCESSORIES

HAULER HORSEPOWER

APPAREL/SIGNAGE

K&N® PRODUCT LISTINGS



OFF-ROAD PERFORMANCE

HIGH-FLOW AIR FILTERS™

- Designed to provide increased airflow
- Pleated media increases surface area and capacity for extreme conditions
- Custom base seal specific to each application
- Washable & reusable
- K&N® One Year Limited Warranty
for details, visit knfilters.com/warranty
- K&N® Drycharger® available for extended service intervals



PERFORMANCE OIL FILTERS™

- 17mm hex nut for easy wrench-off®*
- Pre-drilled for safety wire attachment*
- Premium synthetic blend media provides outstanding filtration at high flow rates
- High-performance anti-drainback valve*
- Heavy duty canister construction

*where applicable



OTHER PRODUCTS FOR OFF-ROAD VEHICLES

AIRCHARGER® INTAKE SYSTEMS†

– FOR ATVs / UTVs / SIDE BY SIDES –



XSTREAM® POWERLID®

– FOR SPORT ATVs –



XSTREAM® SERIES AIR FILTERS

– FOR MOTOCROSS BIKES –



†

SOME INTAKE SYSTEMS ARE NOT LEGAL FOR SALE OR USE ON ANY POLLUTION CONTROLLED MOTOR VEHICLE IN CALIFORNIA OR STATES ADOPTING CALIFORNIA EMISSION PROCEDURES.

See knfilters.com for CARB status on each part for a specific vehicle

See knfilters.com for specifications regarding emissions standards and CARB regulations.

HIGH-FLOW AIR FILTERS™

FOR OFF-ROAD AND MOTOCROSS BIKES

K&N® air filters were originally designed for the extreme demands of off road racing to provide long service intervals and increased performance.

- Pleated media allows low restriction, resulting in improved throttle response, horsepower, and torque
- Deep pleats provides a large surface area, resulting in high capacity
- Fits directly into your stock air box

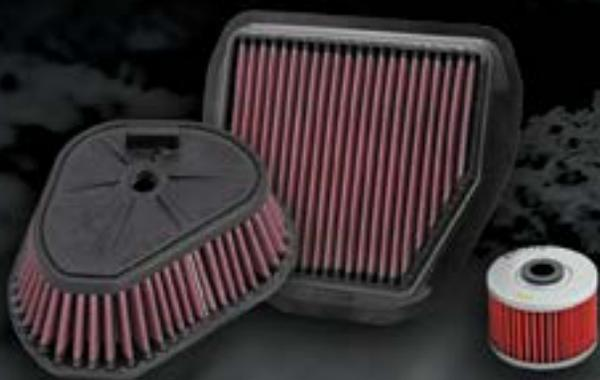

OFF-ROAD MOTORCYCLE REPLACEMENT FILTERS - See page 88 for additional product listings

APRILIA	YEAR	AIR FILTER	OIL FILTER
RXV/SXV 450/550 Enduro	06-11	AL-4506	KN-563
HONDA			
XR80/XR100R	85-03	HA-1088	•
CRF80/100F	04-13	HA-1088	•
CRF150/230F	03-16	HA-1503	•
CR80/85R	86-07	HA-8086	•
CR125/250/500R	91-01	HA-2591	•
CRF250L	13-15	HA-2513	KN-112
XR250R	86-04	HA-1312	KN-112
XR400R	96-04	HA-1314	KN-112
XR650L	93-16	HA-6592	KN-112
XR650R	00-07	HA-6500	KN-112
HUSQVARNA			
FE 250/350	14-16	KT-4511XD	KN-652
FE 450	14-16	•	KN-655
FE 501	14-16	KT-4511XD	KN-655
TC/TE 125/250/300	14-16	KT-4511XD	•
KAWASAKI			
KLX110	02-16	KA-1102	KN-112
KLX125/L	03-06	KA-1203	KN-132
KLX140/L	08-16	KA-1408	KN-112
KX65/80/85/100	91-17	KA-8088	•
KDX200/KDX220R	89-06	KA-1287	•
KLX250S/SF	09-10	•	KN-112
KLX250/300R	96-07	KA-1287	KN-112
KLX450R	08-11	KA-4408	KN-112
KLR650	87-16	KA-6589	KN-123
KTM			
250 SX-F	07-14	KT-4511XD	KN-655
250 XC-F/XCF-W	08-12	KT-4511XD	KN-655
400EXC/XC-W	08-11	KT-4511XD	KN-652

KTM CONTINUED	YEAR	AIR FILTER	OIL FILTER
450EXC/XC-F/XC-W	08-11	KT-4511XD	KN-652
450XC-W	12-16	KT-4511XD	KN-655
450SX-F	07-12	KT-4511XD	KN-652
450SX-F	13-15	•	KN-655
500SXF/EXC-R	13-15	KT-4511XD	KN-652
505SXF/EXC-R	08-12	KT-4511XD	KN-652
530EXC/EXC-R/XC-WR	08-11	KT-4511XD	KN-652
690 SMC	13-16	KT-4511XD	•
690 SMC	08-12	KT-6907	KN-155/157
690 Supermoto	07-08	KT-6907	KN-155/157
690 Enduro	08-16	KT-6908	KN-155/157
950 Super Enduro	06-09	KT-9504	KN-158
990 SM R/SM T	10-14	KT-9907	KN-158
SUZUKI			
RM85/L	86-13	SU-8086	•
DRZ125/L	03-14	KA-1203	KN-132
DRZ250	01-07	SU-2501	KN-136
DRZ400/E/S/SM	00-15	SU-4000	KN-139
DR650SE	96-15	SU-6596	KN-137
YAMAHA			
TTR90/E	00-07	YA-9001	•
TTR125/E/L/LE/LW	00-16	YA-1201	•
TTR225	00-04	YA-2292	KN-143
TTR230	05-16	YA-2305	KN-143
TTR250	00-06	YA-3586	KN-142
YZ85	03-17	YA-8502	•
WR250R/WR250X	07-16	YA-3586	KN-140
XT225	01-07	YA-2292	KN-143
XT250	09-16	YA-2509	KN-140
XT660R/X/Supermotard	04-14	YA-6604	KN-145
YZ450F	10-13	YA-4510	KN-140
YZ450F	14-16	YA-4514XD	KN-140

HIGH-FLOW AIR FILTERS™ FOR OFF-ROAD AND MOTOCROSS BIKES

David Pully 



Designed to provide increased horsepower & crisp throttle response, these air filters inspire longer motos!

- Designed to provide low restriction, resulting in increased throttle response and horsepower
- Pleated media provides a large filtration area and high capacity for extended service intervals
- Multiple layers of tightly woven "XD" cotton gauze media offers excellent filtration in dusty conditions*
- Two-piece design eases installation and removal*
- Custom base seal specific to each application

K&N® XStream® Series Motocross Air Filter.
U.S. Patented Design

*Where applicable



**2-PIECE CONSTRUCTION EASES
INSTALLATION**

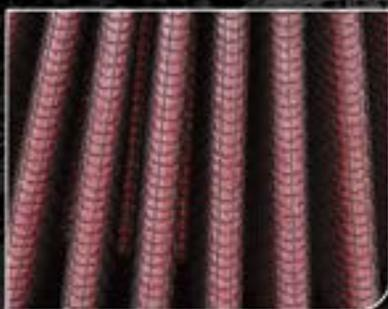

**DEEP PLEATS
PROVIDE HIGH CAPACITY**



**INTEGRATED TONGUE-AND-
GROOVE TOP SEAL**

XSTREAM® SERIES MOTOCROSS AIR FILTERS - See page 88 for additional product listings

HONDA	YEAR	AIR FILTER	OIL FILTER	KTM	YEAR	AIR FILTER	OIL FILTER
CRF150R/Expert	07-17	HA-1507	KN-116	125/200/250/300 EXC/MXC/SX	98-07	KT-5201	•
CRF250R	04-09	HA-4503XD	KN-116	250 SX-F	05-06	KT-5201	KN-655
CRF250R	10-13	HA-4509XD	KN-116	250 SXS/XC/XCF-W	06-07	KT-5201	KN-655
CRF250R	14-16	HA-4513XD	KN-116	400EXC/MXC/XC-W/SX	00-07	KT-5201	KN-155/157
CRF250X/450X	04-17	HA-2505XD	KN-116	450EXC/MXC/XC-W/SMR	03-07	KT-5201	KN-155/157
CRF450R	2002	HA-4502	KN-116	450SX	03-06	KT-5201	KN-155/157
CRF450R	03-08	HA-4503XD	KN-116	525EXC/MXC/SX/XC-W	03-06	KT-5201	KN-155/157
CRF450R	09-12	HA-4509XD	KN-116	SUZUKI			
CRF450R	13-16	HA-4513XD	KN-116	RM125/250	06-08	YA-2506XD	•
HUSQVARNA				RM250	99-04	SU-2596	•
CR/TC/TE/WR 125/250/450/510	03-09	HU-1200	KN-154	RMZ250	04-06	KA-2504	KN-207
TC/TE/TXC 250/310	10-13	HU-1200	KN-116	RMZ250/450	07-16	YA-2506XD	KN-207
KAWASAKI				YAMAHA			
KX125/KX250	97-08	KA-1297	•	YZ125/250	97-17	YA-2506XD	•
KX250F	04-06	KA-2504	KN-207	YZ250F/400F/426F	98-02	YA-2506XD	KN-142
KX250F	06-16	KA-2506XD	KN-207	YZ250F	09-16	YA-2506XD	KN-140
KX450F	06-16	KA-2506XD	KN-112	WR250F/WR450F	09-15	YA-4503	KN-140
				YZ450F	10-13	YA-2506XD	KN-141

AMERICAN V-TWIN

STREET

OFF-ROAD

WATERCRAFT/SNOW

SPECIALTY/ACCESSORIES

HAULER HORSEPOWER

APPAREL/SIGNAGE

K&N® PRODUCT LISTINGS

HIGH-FLOW AIR FILTERS™

SPECIALTY CLAMP-ON AIR FILTERS FOR PIT BIKES

K&N® clamp on racing filters provide the added air flow your bike needs for even better performance.

- Pleated media offers a large surface area for low restriction, resulting in improved throttle response
- Constructed with ultra-strong molded pliable rubber flanges to absorb vibration and allow for secure attachment
- Flanges can be stretched up to 1/16" (1.5mm) to fit in between sizes
- K&N® Drycharger® filter wrap available for use in wet conditions or for extended service intervals.



Legal in California only for racing vehicles which may never be used, registered or licensed upon a highway.



PLEATED MEDIA PROVIDES A LARGE SURFACE AREA



PLIABLE MOLDED FLANGES ABSORB VIBRATION



K&N® DRYCHARGER® INSTALLED

SPECIALTY FILTERS FOR MODIFIED PIT BIKES - See page 272 for additional product listings

APPLICATION	DESCRIPTION	CARB	PART #	PRECHARGER®
CRF50	1 1/8" F, 2 1/4" B, 2" T, 2 1/2" L	16mm	RC-2540	RC-2540PK
CRF50	1 3/8" F, 2 1/2" B, 2" T, 2 14" L	18mm	RC-0790	RC-0790PK
CRF50	1 1/4" F, 3" OD, 3" L	18mm	RU-0060	22-8008PK
CRF50	1 9/16" F, 3" B, 2" T, 3" L	20-22mm	RC-2310	22-8028PK
CRF50	1 11/16" F, 3" B, 2" T, 2 3/4" L	24mm	RC-1070	22-8028PK
CRF50	1 11/16" F, 3 1/2" B, 2" T, 4" L	26-28mm	R-1080	22-8029PK
CRF50	1 11/16" F, 3" B, 2" T, 4" L, 40°F	26-28mm	R-1100	22-8048PK
CRF50	1 7/8" F, 3" B, 2" T, 3 11/16" L, 10°F	28mm	RC-1290	22-8048PK
KLX110/DRZ110	OE replacement filter	Stock	KA-1102	•
KLX110	1 9/16" F, 3 1/2" B, 1 1/2" L	22-26mm	RC-0170	RC-0170DK
KLX110	1 3/4" F, 3 1/2" B, 1 1/2" L	26-28mm	RC-2870	RC-0170DK
KLX110	1 3/4" offset F, 4 1/2" B, 1 1/2" L	26-28mm	RC-0330	25-0330

HIGH-FLOW AIR FILTERS™

SPECIALTY CLAMP-ON AIR FILTERS FOR DIRT TRACK RACING

2013 GNC Champion Brad Baker and 2014 GNC Champion Jared Mees



These dirt track air cleaners are large by design to allow extra dirt holding capacity without restricting air flow.

- Constructed with strong molded, pliable rubber flanges that absorb vibration and allow for secure attachment
- The "D" shaped oval filter with a long neck permits clamping onto the velocity stack in such a manner as not to obstruct the airflow to the velocity stack
- K&N® Drycharger® filter wrap available for extended service intervals



**PLIABLE MOLDED FLANGES
ABSORB VIBRATION**



**K&N® DRYCHARGER®
INSTALLED**



**XSTREAM® SERIES
AIR FILTER INSTALLED**

SPECIALTY FILTERS FOR DIRT TRACK RACING - See page 272 for additional product listings

FLANGE ID	SHAPE	DIMENSIONS	FLANGE STYLE	PART #	PRECHARGER®
2-1/4"	Round	3-1/2" outer diameter, 5" high	5/8" long	RU-0610	RU-0510PK
2-1/4"	Round	3-1/2" outer diameter, 6" high	20° angle 1" long	RU-1720	RU-0520PK
2-7/16"	Oval	4-1/2" X 3-3/4", 6" high	10° angle 1" long	RU-1230	RU-1230PK
2-7/16"	Oval	4-1/2" X 3-3/4", 7" high	10° angle 1" long	RU-1240	RU-1240PK
2-7/16"	Oval	4-1/2" X 3-3/4", 9" high	10° angle 1" long	RU-1260	RU-1260PK
2-7/16"	XStream Round	4-1/2" base, 4" top, 6-1/8" high	20° angle 2-15/16" long	RX-3800	RX-3820PK
2-1/2"	"D" Oval	4-1/2" X 3-3/4", 7" high	10° angle 2-1/8" long	RU-1830	RU-1240PK
2-1/2"	"D" Oval	4-1/2" X 3-3/4", 9" high	10° angle 2-1/8" long	RU-1840	RU-1260PK
2-1/2"	Round	3-1/2" outer diameter, 4" high	5/8" long	RD-0700	RU-0500PK
2-1/2"	Round	3-1/2" outer diameter, 6" high	5° angle 1" long	RB-0720	RU-0520PK

These products are not street legal on vehicles with regulated emission control systems unless used as a direct replacement air filter for a street legal intake system.

HIGH-FLOW AIR FILTERS™

FOR SPORT ATVs

Bolt-on performance that offers long life and is extremely easy to maintain in racing or extreme conditions.

- Designed to provide low restriction, resulting in increased throttle response and horsepower
- Pleated media provides a large filtration area and high capacity for extended service intervals
- K&N® Drycharger® available for wet conditions or extended service intervals



Wienen Motorsports - Chad Wienen

Photo: Harlen Foley

SPORT ATV REPLACEMENT FILTERS - See page 239 for additional product listings

ARCTIC CAT	YEAR	AIR FILTER	FILTER WRAP	OIL FILTER
DVX400/TS	04-08	SU-4002	SU-4002PK	KN-139
CAN-AM				
DS450X/MX/XC	08-15	CM-4508	CM-4508DK	KN-560
DS650/X	00-07	BD-6500	YA-3502PK	KN-152
HONDA				
TRX90	94-16	HA-1088	22-8008PK	•
TRX250EX / X	01-16	HA-2501	YA-3504PK	•
TRX300EX/X	93-09	HA-3094	HA-3094PR	KN-113
TRX400EX/X	99-14	HA-4099	22-8016PK	KN-113
TRX450R	04-05	HA-4504	HA-4504PR	KN-116
TRX450R/ER	06-14	BD-6500	YA-3502PK	KN-116
TRX700XX	08-09	HA-6808	•	KN-112
KAWASAKI				
KFX80	03-06	SU-8087	•	•
KFX450R	08-14	KA-4508	KA-4508DK	KN-112
KFX700	04-11	KA-6503	KA-6503PK	KN-204
KYMCO				
KXR250	2004	KY-2504	SU-2504PK	•
Mongoose 250/300	06-10	KY-2504	SU-2504PK	•

POLARIS	YEAR	AIR FILTER	FILTER WRAP	OIL FILTER
Outlaw 450 MXR	08-09	•	•	KN-155/157
Outlaw 525	07-11	PL-5207	PL-5207DK	KN-155/157
SUZUKI				
LT80 QuadSport	87-06	SU-8087	•	•
LTZ250 QuadSport	04-09	SU-2504	SU-2504PK	KN-132
LTZ400 QuadSport	03-13	SU-4002	SU-4002PK	KN-139
LTR450 Quadracer	06-09	SU-4506	SU-4506DK	KN-139
YAMAHA				
YFM125/250 Raptor	09-13	YA-2088	YA-2088PK	•
YFS200 Blaster	88-06	YA-2088	YA-2088PK	•
YFM250R Raptor	08-13	YA-2088	YA-2088PK	KN-140
YFM350R Raptor	04-13	YA-6602	YA-4350PK	KN-142
YFM350X Warrior	87-04	YA-4350	YA-4350PK	KN-141
YFZ350 Banshee	87-06	YA-3502	YA-3502PK	KN-142
YFZ450	04-06	YA-4504	YA-4504PK	KN-141
YFZ450R/SE	07-16	YA-4504	YA-4504PK	KN-140
YFM660R Raptor	01-05	YA-6601	YA-6601DK	KN-145
YFM700R Raptor	06-16	YA-7006*	RU-0520PK	KN-145

*NOTE: Includes Billet Intake Adaptor

SPECIALTY FILTERS FOR ATV RACING - See page 272 for additional product listings

K&N® specialty filters for ATV racing are designed to be used on aftermarket oversized billet intake adapters.

FLANGE I.D.	BASE	TOP	HEIGHT	PART#	FILTER WRAP	FLANGE I.D.	BASE	TOP	HEIGHT	PART#	FILTER WRAP
2-7/8"	4"	4"	6"	RU-1620	RU-1470PK	3 1/2"	4 5/8"	3 1/2"	7"	RU-3130	RU-3130DK
3" 5"	4 1/2"	4 1/2"	4"	RB-0900	RB-0900DK	4"	5 3/8"	4 3/8"	5"	RU-2520	•
3"	5"	5"	5"	RU-2430	RU-2430PK	4"	5 3/8"	4 3/8"	7"	RU-2590	RU-2590DK
3-1/2"	5"	5"	3"	RU-1790	22-8015PK	4 1/2"	5 7/8"	5"	3-1/4"	RU-3110	•
3-1/2"	5"	3 1/2"	4"	RU-2990	•	4 1/2"	5 7/8"	4 1/2"	6"	RU-4740	22-8033PK
3-1/2"	5"	5"	5 5/8"	RU-5114	CM-4508DK	4 1/2"	5 7/8"	5"	6"	RU-3480	RU-3480PK

* Add C for Chrome

HIGH-FLOW AIR FILTERS™ FOR UTILITY ATVs

Suzuki KingQuad 



Simple installation provides long life and low end power for trail riding or working the farm.

- Designed to provide low restriction, resulting in increased horsepower and torque
- Pleated media provides a large filtration area and high capacity for long service intervals
- Washable, reusable, pre-oiled, and ready to install
- K&N® Drycharger® available for wet conditions or extended service intervals



UTILITY ATV REPLACEMENT FILTERS - See page 239 for additional product listings

ARCTIC CAT	YEAR	AIR FILTER	FILTER WRAP	OIL FILTER
250/300 2x4/4x4	98-05	AC-3098	AC-3098PK	KN-132
400 4X4	06-08	AC-4004	•	KN-138
500 4X4	05-09	AC-4004	•	KN-138
550/650/700	08-15	AC-7009	•	KN-621
1000XT/H2/Mud Pro	13-14	AC-1009	•	KN-621
CAN-AM				
Outlander/Renegade 500	07-12	BD-6506	22-8016PK	KN-152
Outlander/Renegade 500	13-15	CM-8012	•	KN-152
Outlander/Renegade 650	07-12	BD-6506	22-8016PK	KN-152
Outlander Max 650	09-12	CM-8009	•	KN-152
Outlander/Renegade 650	12-15	CM-8012	•	KN-152
Outlander 800	07-08	BD-6506	22-8016PK	KN-152
Outlander Max 800	09-12	CM-8009	•	KN-152
Outlander/Renegade 800/1000	12-15	CM-8012	•	KN-152
HONDA				
TRX250 Recon	02-14	HA-2501	HA-3504PK	•
TRX350/400 Rancher	00-06	HA-3500	HA-3500PR	KN-113
TRX420 Rancher	07-14	HA-4207	•	KN-113
TRX500 Foreman	05-14	HA-5000	HA-5000PK	KN-113
TRX500 Foreman Rubicon	01-11	HA-5000	HA-5000PK	KN-111
TRX500 Foreman Rubicon	12-16	HA-6806	HA-6806DK	KN-111
TRX680 Rincon	06-16	HA-6806	HA-6806DK	KN-111
KAWASAKI				
KLF220 Bayou	88-02	KA-2288	KA-2288PL	KN-123
KLF250 Bayou	03-11	KA-2288	KA-2288PL	KN-123
KLF300 Bayou	89-04	KA-4093	KA-4093PL	KN-123
KVF360 Prairie	03-13	KA-3603	KA-3603PK	KN-204
KVF650 Prairie	2002	KA-6502	•	KN-204
KVF650 Brute Force	03-13	KA-6503	KA-6503PK	KN-204
KVF650 Brute Force 4X4i	07-13	KA-7504	KA-7504PK	KN-204
KVF700 Prairie	04-06	KA-6503	KA-6503PK	KN-204

KAWASAKI CONTINUED	YEAR	AIR FILTER	FILTER WRAP	OIL FILTER
KVF750 Brute Force	08-15	KA-7408	KA-7408DK	KN-204
KYMCO				
MXU 250/300/400	05-09	KY-2504	SU-2504PK	•
POLARIS				
Phoenix 200	05-17	PL-1004	PL-1004PK	•
Hawkeye/Sportsman 300	06-10	PL-1004	PL-1004PK	KN-303
Trail Boss 325/330	02-09	PL-1005	HA-3094PK	KN-303
Trail Blazer/Trail Boss 330	10-13	PL-1003	PL-1003PK	KN-303
Sportsman 400	08-14	PL-1003	PL-1003PK	KN-303
Sportsman/Scrambler 500	97-13	PL-1003	PL-1003PK	KN-303
Sportsman 550	10-14	PL-1003	PL-1003PK	•
Sportsman 550 XP	09-12	PL-5509	PL-1003PK	•
Sportsman 800	05-14	PL-1003	PL-1003PK	KN-198
Sportsman 850	07-16	PL-1003	PL-1003PK	•
Sportsman XP 850	09-14	PL-5509	PL-1003PK	•
SUZUKI				
LTF250 Ozark	02-14	SU-2504	SU-2504PK	KN-132
LTA400A/F KingQuad	08-15	SU-5002	SU-4002PK	KN-138
LTF400 Eiger/500F Vinson	02-07	SU-5002	SU-4002PK	KN-138
LTA450X KingQuad	07-09	SU-7005	SU-7005DK	KN-138
LTA500XP KingQuad	11-14	SU-5002	SU-4002PK	KN-138
LTA700X KingQuad	05-07	SU-7005	SU-7005DK	KN-138
LTA750X KingQuad	08-15	SU-7005	SU-7005DK	KN-138
YAMAHA				
YFM125/250 Grizzly	08-13	YA-2088	YA-2088PK	•
YFM350 Grizzly	07-14	YA-3504	YA-3504PK	KN-204
YFM450 Grizzly	05-14	YA-3504	YA-3504PK	KN-204
YFM550 Grizzly	09-14	YA-7007	•	KN-204
YFM660 Grizzly	07-08	YA-6602	YA-4350PK	KN-204
YFM500/700F Grizzly	09-15	YA-7007	•	KN-204
YFM700F Grizzly	2016	YA-7016	•	KN-147

AMERICAN V-TWIN

STREET

OFF-ROAD

WATERCRAFT/SNOW

SPECIALTY/ACCESSORIES

HAULER HORSEPOWER

APPAREL/SIGNAGE

K&N® PRODUCT LISTINGS

HIGH-FLOW AIR FILTERS™ FOR SIDE BY SIDES

Great for sand dunes or extreme conditions, these filters provide increased performance and long service life with simple installation.

- Designed to provide low restriction, resulting in increased throttle response and horsepower
- Pleated media provides a large filtration area and high capacity for long service intervals
- K&N® Drycharger® available for wet conditions or extended service intervals



H&M Motorsports - Davi Haagsma

Photo: Harlen Foley

SIDE BY SIDE REPLACEMENT FILTERS - See page 239 for additional product listings

ARCTIC CAT	YEAR	AIR FILTER	FILTER WRAP	OIL FILTER
Prowler 550	09-15	AC-7009	•	•
Prowler 650 H1	06-07	AC-4004	•	KN-621
Prowler 700	09-15	AC-7009	•	KN-621
Wildcat Trial/Sport 700	14-16	AC-7014	•	•
Wildcat 1000	13-14	AC-1012	AC-1012DK	KN-621
CAN-AM				
Commander 800/1000	11-15	CM-8011	•	KN-152
Maverick 1000 X DS	2015	CM-9715	•	KN-152
Maverick 1000	13-15	CM-8011	•	KN-152
HONDA				
MUV700 Big Red	09-13	HA-5000	HA-5000PK	KN-111
Pioneer 500	15-17	HA-5015	•	•
SXS700 Pioneer	14-16	HA-5000	HA-5000PK	KN-111
JOHN DEERE				
Gator	All	E-4552	•	•
KAWASAKI				
KAF400 Mule 400/600	05-16v	KA-4093	KA-4093PL	KN-128
KAF620/950 Mule	01-16	KA-6201	•	KN-128
KRF750 Teryx 4X4	08-12	KA-7508	KA-7508DK	KN-204
KRT750 Teryx4	12-13	KA-7512	•	KN-204
KRF750 TERYX FI 4X4	2013	KA-7513	•	KN-204

POLARIS	YEAR	AIR FILTER	FILTER WRAP	OIL FILTER
Ranger RZR 170	10-14	PL-1710	PL-1004PK	•
Sportsman Ace 325	14-16	PL-3214	PL-3214DK	•
Ranger 400	10-14	PL-5008	PL-5008DK	KN-303
Ranger 500 4x4 EFI	06-13	PL-5008	PL-5008DK	KN-303
Ranger RZR 570	12-15	PL-5712	•	KN-198
Ranger 700	07-09	PL-5008	PL-5008DK	KN-198
Ranger XP 760	11-12	PL-8007	PL-8007DK	•
Ranger RZR/S 800	08-14	PL-8007	PL-8007DK	KN-198
Ranger Crew 800	11-14	PL-8007	PL-8007DK	KN-198
Ranger XP 875	13-14	PL-5712	•	KN-198
Ranger RZR XP 900	15-16	PL-8715	PL-1014-1DK	•
Ranger RZR XP 900	2013	PL-9011	•	KN-198
Ranger RZR XP1000	14-16	PL-1014	PL-1014-1DK	KN-198
YAMAHA				
YXR450 Rhino	07-09	YA-6504	YA-6504PK	KN-204
YXR660 Rhino	04-06	YA-6504	YA-6504PK	KN-303
YXR660 Rhino	2007	YA-6504	YA-6504PK	KN-204
YXR700 Rhino	08-13	YA-7008	YA-7008DK	KN-204
YXM700 Viking	14-16	•	•	KN-204

HIGH-FLOW AIR FILTERS™ FOR SPORT ATVs

Photo: Harlen Foley

CT Racing - Danny Prather



Developed to provide increased capacity for extreme conditions found in long distance desert racing.

- Replaces restrictive stock air box lid and snorkles
- Increases capacity for extreme conditions
- Mounts using OEM mounting tabs
- Use in conjunction with a K&N® High-Flow Air Filter™ for increased performance

K&N® ATV Powerlid® Air Filter. U.S. Patented Design



**INCLUDES NECESSARY
JETS**



**DRYCHARGER® INCLUDED FOR
EXTENDED SERVICE INTERVALS**



**INCREASES CAPACITY FOR
EXTREME CONDITIONS**

SPORT ATV XSTREAM® POWERLID®

ARCTIC CAT	CC	YEAR	POWERLID®	POWERLID® DRYCHARGER®
DVX400/TS	400	04-08	SU-4002-T	SU-4002-TDK
HONDA				
TRX400EX	400	99-09, 12-14	HA-4099-T	HA-4099-TDK
TRX450R	450	04-05	HA-4504-T	HA-4504-TDK
TRX450R/ER	450	06-09, 12-14	HA-4506-T	HA-4504-TDK
KAWASAKI				
KFX400	400	03-06	SU-4002-T	SU-4002-TDK
SUZUKI				
LTX400 QuadSport	400	03-09, 12-13	SU-4002-T	SU-4002-TDK
YAMAHA				
YZF350 Banshee	350	87-06	YA-3502-T	YA-3502-TDK
YZF450/SE	450	04-13	YA-4504-T	YA-4504-TDK
YFM660R Raptor	660	01-05	YA-6601-T	YA-6601-TDK

AMERICAN V-TWIN

STREET

OFF-ROAD

WATERCRAFT/SNOW

SPECIALTY/ACCESSORIES

HAULER HORSEPOWER

APPAREL/SIGNAGE

K&N® PRODUCT LISTINGS

AIRCHARGER® INTAKE SYSTEMS† FOR SPORT ATVs

Developed for Motocross and TT, these complete systems are designed to increase horsepower for your sport ATV.

- Guaranteed to increase horsepower
- Completely replaces the OE air box assembly
- Roto-molded polyethylene intake tube offers low restriction
- Oversized powder-coated airbox / heat shield
- Oversized K&N® "XD" High-Flow Air Filter™ for high capacity and efficiency
- Includes K&N® Drycharger® and separate crankcase breather*

*Where applicable



DASA Racing - Jared Hulliung

Photo: www.GarrettHamilton.com

† SOME INTAKE SYSTEMS ARE NOT LEGAL FOR SALE OR USE ON ANY POLLUTION CONTROLLED MOTOR VEHICLE IN CALIFORNIA OR STATES ADOPTING CALIFORNIA EMISSION PROCEDURES. See knfilters.com for CARB status on each part for a specific vehicle

See knfilters.com for specifications regarding emissions standards and CARB regulations.



REPLACES OE AIR BOX



ROTO-MOLDED HIGH-FLOW INTAKE TUBE



DRYCHARGER® INSTALLED
(Where applicable)

AIRCHARGER® INTAKE SYSTEMS – SPORT ATV

APPLICATION	YEAR	PART #	EST. HP GAIN†	EXTRA FILTER
Honda TRX450R¹	04-05	63-1127*	+ 3 hp¹	RU-4960XD
Kawasaki KFX450R	08-09	57-1124	+ 5 hp¹	RC-4630XD
Suzuki LTR450	06-08	57-1128	+ 3 hp¹	RC-5182XD
Yamaha YFZ450 (Carburated Models)¹	04- 09	63-1123*	+ 4 hp¹	RU-4960XD

1) Jetting modifications will be necessary to obtain maximum performance.

*Not legal for sale or use on any pollution controlled motor vehicle in California or states adopting California emission procedures. †Estimated horsepower and torque gains based on specific or similar vehicle dynamometer tests. Results will vary. Visit knfilters.com for specifications regarding emissions standards and CARB regulations and additional testing and estimated horsepower information.

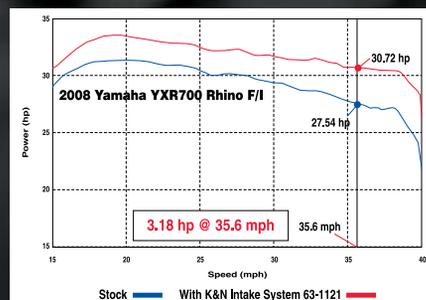

Estimated horsepower and torque gains based on specific or similar vehicle dynamometer tests. Results will vary.

AIRCHARGER® INTAKE SYSTEMS† FOR SIDE BY SIDES

Photo: Harlen Foley

Polaris XP900



Developed for closed-course racing, these complete intake systems are designed to increase horsepower for your side by side.

- Guaranteed to increase horsepower
- Completely replaces the OE air box assembly
- Powder-coated mandrel-bent high-flow intake tube(s)* offer low restriction
- Oversized powder-coated air box / heat shield
- Oversized K&N® "XD" High-Flow Air Filter™ for high capacity and efficiency
- Includes K&N® Drycharger® and separate crankcase breather*

*Where applicable



†

SOME INTAKE SYSTEMS ARE NOT LEGAL FOR SALE OR USE ON ANY POLLUTION CONTROLLED MOTOR VEHICLE IN CALIFORNIA OR STATES ADOPTING CALIFORNIA EMISSION PROCEDURES.

See knfilters.com for CARB status on each part for a specific vehicle

See knfilters.com for specifications regarding emissions standards and CARB regulations.



MANDREL-BENT ALUMINUM INTAKE TUBES

(Where applicable)



OVERSIZED "XD" AIR FILTER



POWDER-COATED AIR BOX AND INTAKE TUBE

(Where applicable)

AIRCHARGER® INTAKE SYSTEMS – SIDE BY SIDES

DESCRIPTION	YEARS	PART #	EST. HP GAIN**	REPLACEMENT AIR FILTER	REPLACEMENT DRYCHARGER®
Can-Am Maverick	2015-16	63-1135*	+ 1 hp**	RU-2805XD	•
Polaris Ranger RZR XP 900 Intake System	2011-14	57-1129	+ 2 hp**	RC-5062XD	RC-5062DK
Polaris Ranger RZR/S 800 Intake System	2008-13	57-1120	+ 3 hp**	RX-4730XD	RX-3810DK
Replacement Vent Filter for #63-1120 Intake System	2008-13	62-1300	•	•	62-1300DK
Suzuki LTR 450	06-08	57-1128	+ 2 hp**	RC-5182XD	RC-5182DK
Yamaha YXR700 Rhino Intake System	2008-11	57-1121	+ 3 hp**	RC-2960XD	22-8049DK
Yamaha YXR660 Rhino Intake System	2004-07	63-1119*	+ 4 hp**	RX-3810XD	RX-3810DK
Yamaha YXR660 Rhino CVT Clutch Filter Kit	2004-07	RK-3920	•	•	•

*Not legal for sale or use on any pollution controlled motor vehicle in California or states adopting California emission procedures.

**Estimated horsepower and torque gains based on specific or similar vehicle dynamometer tests. Results will vary. Visit knfilters.com for specifications regarding emissions standards and CARB regulations and additional testing and estimated horsepower information.

AMERICAN V-TWIN

STREET

OFF-ROAD

WATERCRAFT/SNOW

SPECIALTY/ACCESSORIES

HAULER HORSEPOWER

APPAREL/SIGNAGE

K&N® PRODUCT LISTINGS



WATERCRAFT/ SNOWMOBILE

HIGH-FLOW AIR FILTERS™

- Cotton media is designed to provide low restriction resulting in increased horsepower & torque
- Pleated media offers a large surface area, for high-capacity in extreme conditions
- Constructed with ultra-strong molded pliable rubber flanges which absorb vibration and allow for secure attachment
- Flanges can be stretched up to 1/16" (1.5mm) to fit in-between sizes
- K&N® One Year Limited Warranty
for details, visit knfilters.com/warranty



WRENCH-OFF® OIL FILTERS

- 17mm hex nut for easy wrench-off® in hard to reach places*
- Pre-drilled for safety wire attachment*
- Premium synthetic blend media provides outstanding filtration at high flow rates
- High-performance anti-drainback valve*
- Heavy duty canister construction

*where applicable



OTHER PRODUCTS FOR WATERCRAFT

RACING FLAME ARRESTORS

– FOR PERSONAL WATERCRAFT –



CARBURETOR ADAPTORS

– FOR PERSONAL WATERCRAFT –



FLAME ARRESTORS FOR PERSONAL WATERCRAFT

Built for personal watercraft racing, these marine approved flame arrestors are designed to legally increase performance on your PWC.

- Epoxy-coated aluminum wire mesh backfire screen resists corrosion
- Polished stainless steel top plates provide resistance to salt water
- Marine approved and meets US Coast Guard standards
- Use with K&N® Drycharger® filter wrap to limit water from reaching flame arrestor



Legal in California only for racing vehicles which may never be used, registered or licensed upon a highway.



**FLAME ARRESTOR
#59-2046 INSTALLED**



**FLAME ARRESTOR
#59-2040RR INSTALLED**



**FLAME ARRESTOR
#59-2045 INSTALLED**

DRYCHARGER® FLAME ARRESTOR WRAPS

The hydrophobic nature of our polyester Drycharger® wraps limits the amount of water that reaches the flame arrestor. K&N® filter wraps are designed to repel water, but will not seal against complete submersion.

FITS PART #	SIZE	RED #	BLUE #
59-2000	4 1/2 x 7 x 2	22-2000PR	22-2000PL
59-2015	4 1/2 x 7 x 3 tapered	22-2015PR	22-2015PL
59-2020, 59-2860	4 1/2 x 7 x 3	22-2020PR	22-2020PL
59-2030	Round conical 6" tall	22-2030PR	22-2030PL
59-2040 (R, RK, RR)	Round conical 4" tall	22-2040PR	22-2040PL
59-2870, 59-2890, 59-2900	5 1/2 x 9 x 2 1/2 oval	22-2840PR	22-2840PL
59-2910, 59-2840R	5 1/2 x 9 x 2 1/2 oval	22-2840PR	22-2840PL
59-2042R (RK)	Round conical 2 1/2" tall	22-2042PR	



PART NUMBER
22-2040PL



PART NUMBER
22-2042PR

FLAME ARRESTORS FOR PERSONAL WATERCRAFT

WATERCRAFT FLAME ARRESTORS

OVAL - STRAIGHT FLANGE

FLANGE	BASE	TOP	HEIGHT	FLAME ARRESTOR	DRYCHARGER®
2"	4 1/2" x 7"	4 1/2" x 7"	3"	59-2020	22-2020*
2 3/4"	4 1/2" x 7"	4 1/2" x 7"	2"	59-2000	22-2000*
2 3/4"	4 1/2" x 7"	4 1/2" x 7"	3"	59-2860	22-2020*



PART NUMBER
59-2000

OVAL - 40° ANGLED FLANGE

FLANGE	BASE	TOP	HEIGHT	FLAME ARRESTOR	DRYCHARGER®
2 3/4", 40°	4 1/2" x 7"	4 1/2" x 7"	3"	59-2010	22-2020*



PART NUMBER
59-2010

OVAL BASE, OVAL TOP - 40° ANGLED FLANGE

FLANGE	BASE	TOP	HEIGHT	FLAME ARRESTOR	DRYCHARGER®
2 3/4", 40°	4 1/2" x 7"	4" x 6 1/4"	3"	59-2015	22-2015*



PART NUMBER
59-2015

ROUND TAPERED

FLANGE	BASE	TOP	HEIGHT	FLAME ARRESTOR	DRYCHARGER®
3 3/4"	5 1/4"	3"	6"	59-2030	22-2030*



PART NUMBER
59-2030

"D" SHAPED

FLANGE	BASE	TOP	HEIGHT	COLOR	FLAME ARRESTOR	DRYCHARGER®
2 3/4"	4 1/2"	3"	4"	Stainless	59-2040	22-2040*



PART NUMBER
59-2040

OVAL - DUAL FLANGE

FLANGE	CENTER TO CENTER	BASE	TOP	HEIGHT	FLAME ARRESTOR	DRYCHARGER®
2 3/4"	4 1/16"	5 1/2" x 9"	5 1/2" x 9"	2"	59-2830	•
2 3/4"	4 1/4"	5 1/2" x 9"	5 1/2" x 9"	2"	59-2880	•
2 3/4"	3 13/16"	5 1/2" x 9"	5 1/2" x 9"	2 1/2"	59-2910	22-2840*
2 3/4"	4 1/16"	5 1/2" x 9"	5 1/2" x 9"	2 1/2"	59-2840	22-2840*
2 3/4"	4 1/4"	5 1/2" x 9"	5 1/2" x 9"	2 1/2"	59-2870	22-2840*
2 3/4"	4 3/4"	5 1/2" x 9"	5 1/2" x 9"	2 1/2"	59-2890	22-2840*
2 3/4"	4 3/4"	5 1/2" x 9"	5 1/2" x 9"	2 1/2"	59-2900	22-2840*



PART NUMBER
59-2910

WATERCRAFT FLAME ARRESTORS - FOR RACING ONLY

ROUND TAPERED - FOR RACING ONLY

FLANGE	BASE	TOP	HEIGHT	FLAME ARRESTOR	DRYCHARGER®
2 3/4"	4"	3 1/2"	2 1/4"	59-2045	59-2045DK
2 3/4"	4"	3 1/2"	2 3/4"	59-2046	22-2042PR

PART NUMBER
59-2046



"D" SHAPED - FOR RACING ONLY

FLANGE	BASE	TOP	HEIGHT	COLOR	FLAME ARRESTOR	DRYCHARGER®
2 3/4"	4 1/2"	3 1/2"	2 1/2"	Black	59-2042RK	22-2042PR
2 3/4"	4 1/2"	3 1/2"	2 1/2"	Chrome	59-2042R	22-2042PR
2 3/4"	4 1/2"	3"	4"	Black	59-2040RK	22-2040*
2 3/4"	4 1/2"	3"	4"	Red	59-2040RR	22-2040*
2 3/4"	4 1/2"	3"	4"	Stainless	59-2040R	22-2040*

PART NUMBER
59-2042R



OVAL - DUAL FLANGE

FLANGE	CENTER TO CENTER	BASE	TOP	HEIGHT	FLAME ARRESTOR	DRYCHARGER®
2 3/4"	4 1/16"	5 1/2" x 9"	5 1/2" x 9"	2 1/2"	59-2840R	22-2840*

PART NUMBER
59-2840R



*Add "PL" to end of part number for blue Drycharger®, or add "PR" to end of part number for red Drycharger®

FLAME ARRESTOR ADAPTERS FOR PERSONAL WATERCRAFT

WATERCRAFT FLAME ARRESTOR ADAPTERS

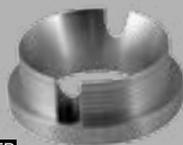

PART NUMBER
85-9291

STYLE 1 CARB ADAPTOR	FLANGE SIZE	VENTURI DIAMETER	BOLT CIRCLE DIAMETER	INCLUDED MOUNTING HARDWARE	PART #
2 bolt Keihin 28M	2 3/4" OD	1.645" ID	2.65"	(2) 6 mm-1.00x105 mm SS bolts	85-9265
Keihin 38/40/42	2 3/4" OD	1.965" ID	2.65"	(2) 6 mm-1.00x105 mm SS bolts	85-9291



PART NUMBER
85-9496

STYLE 2 CARB ADAPTOR	FLANGE SIZE	VENTURI DIAMETER	BOLT CIRCLE DIAMETER	INCLUDED MOUNTING HARDWARE	PART #
Mikuni 38mm w/oil Inj.	2 3/4" OD	1.625" ID	2.165"	(3) 6 mm-1.00x20 mm SS bolts (1) 90° vent, 1/8" hose	85-9394*
Yamaha (Mikuni44)	2 3/4" OD	1.845" ID	2.50"	(4) 6 mm-1.00x20 mm SS bolts (2) 90° vents, 1/8" hose	85-9496*



PART NUMBER
85-9329

STYLE 3 CARB ADAPTOR	FLANGE SIZE	VENTURI DIAMETER	BOLT CIRCLE DIAMETER	INCLUDED MOUNTING HARDWARE	PART #
Keihin 40-31	2 3/4" OD	1.845" ID	2.65"	(2) 6 mm-1.00x105 mm SS bolts	85-9231
Mikuni BN38/37-B1	2 3/4" OD	1.960" ID	2.568"	(2) 6 mm-1.00x20 mm SS bolts	85-9294
Mikuni 28/34/38	2 3/4" OD	1.625" ID	2.165"	(3) 6 mm-1.00x20 mm SS bolts	85-9329
Mikuni 44mm	2 3/4" OD	1.845" ID	2.50"	(4) 6 mm-1.00x20 mm SS bolts	85-9445
Mikuni BN46	2 3/4" OD	1.960" ID	2.50"	(4) 6 mm-1.00x20 mm SS bolts	85-9446

PART NUMBER
85-9001



STYLE 4 - CARBURETOR BRACKET (USE WITH 85-9294 OR 85-9329)	PART #
Sea Doo XP,HX,SPX. Use with adaptor to prevent intake manifold from cracking. Use one per vessel.	85-9000
Sea Doo XP800,GTX. Use with adaptor to prevent intake manifold from cracking. Use one per vessel.	85-9001

PART NUMBER
85-9388



STYLE 5 CARB ADAPTOR	FLANGE SIZE	VENTURI DIAMETER	BOLT CIRCLE DIAMETER	INCLUDED MOUNTING HARDWARE	PART #
38MM, w/cable bracket	2 3/4" OD	1.625" ID	2.165"	(3) 6 mm-1.00x20 mm SS bolts	85-9388

PART NUMBER
85-9491



STYLE 6 CARB ADAPTOR	FLANGE SIZE	VENTURI DIAMETER	BOLT CIRCLE DIAMETER	INCLUDED MOUNTING HARDWARE	PART #
Yamaha VXR 650 Mikuni 44	2"	1.845" ID	2.50"	(4) 6 mm-1.00x20 mm SS bolts (2) 90° vents, 1/8" hose	85-9491

PART NUMBER
85-9287



STYLE 7 CARB ADAPTOR	FLANGE SIZE	VENTURI DIAMETER	BOLT CIRCLE DIAMETER	INCLUDED MOUNTING HARDWARE	PART #
Kawasaki X2 28mm Keihin	2 3/4" OD	1.645" ID	2.65"	(2) 6 mm-1.00x105 mm SS bolts	85-9287

*Uses a two piece design to assure that mounting bolts cannot come loose

PERFORMANCE OIL FILTERS FOR PERSONAL WATERCRAFT

Photo: Anna Glennon-Jet Girls Racing

Team Faith - Kelly Smith



Designed to be compatible with both of today's premium synthetic and traditional style oils, the affixed 17mm hex nut can allow for quick and easy oil changes inside a hard to reach watercraft hull.

- 17mm hex nut for easy wrench-off® *
- Pre-drilled for safety wire attachment*
- Premium synthetic blend media provides outstanding filtration at high flow rates
- High-performance anti-drainback valve*
- Heavy duty canister construction

*Where applicable



WATERCRAFT OIL FILTERS - Visit knfilters.com for additional product listings

HONDA	SIZE	YEAR	PART #	SEA DOO CONTINUED	SIZE	YEAR	PART #
ARX1200T3 Aquatrax F-12/R-12	1235	2002-07	KN-204	Islandia SE	1494	2007-08	KN-556
ARX1200T3D Aquatrax F-12X GPScope	1235	2005-07	KN-204	RXP/RXT	1494	2005-15	KN-556
ARX1500N3 Aquatrax F-15	1470	2009	KN-204	Speedster Wake	1494	2006-09	KN-556
ARX1500T3 Aquatrax F-15X	1470	2008-09	KN-204	Sportster SCIC	1494	2005	KN-556
KAWASAKI				Wake	1494	2005-16	KN-556
JT1200 STX-12F	1176	2003-06	KN-204	GTR 215	1503	2014-16	KN-556
JT1200 STX-12F	1176	2007	KN-303	GTS 130	1503	2014-16	KN-556
JT1500 STX-15F	1493	2004-09	KN-204	GTX 155/Limited 215/iS260	1503	2014-16	KN-556
JT1500 STX	1498	2010	KN-204	RXP-X 260	1503	2014-15	KN-556
JT1500 STX-15F	1498	2010-16	KN-204	RXT 260/X 260	1503	2014-16	KN-556
JT1500 STX-15F	1498	2012	KN-116	Wake 155/Pro 215	1503	2014-16	KN-556
JT1500 Ultra 260 X/LX	1498	2010	KN-204	YAMAHA			
JT1500 Ultra 300 LX/X	1498	2013	KN-204	FAT1100 212SS/212X	998	2008-09	KN-204
JT1500 Ultra 310LX/R/X/SE	1498	14-16	KN-204	FRT1100 AR210 Eng 1	998	2006-07	KN-303
JT1500 Ultra LX	1498	2010-11	KN-204	FRT1100 AR210 Eng 1	998	2008-09	KN-204
JT1500 Ultra LX	1498	2012	KN-116	FRT1100 SR210/SX210	998	2006-07	KN-303
JT1500 Ultra LX	1498	2013-14	KN-204	FRT1100 SX210	998	2008	KN-204
Ultra 300 LX/X	1498	2011-12	KN-204	FX1000 WaveRunner	998	2005-07	KN-303
JT1500 STX	1500	2009	KN-204	FX1000 WaveRunner	998	2008	KN-204
JT1500 Ultra 250X	1500	2007-08	KN-204	SRT1000 AR230/SR230/SX230	998	2003-05	KN-303
JT1500 Ultra 260 LX	1500	2009	KN-204	SRT1100 SX230 H.O.	998	2005-06	KN-303
JT1500 Ultra 260 X	1500	2009	KN-204	SXT1100 232 Limited Eng 1	998	2008-09	KN-204
JT1500 Ultra LX	1500	2007-09	KN-204	SXT1100 AR230 H.O. Eng 1	998	2007	KN-303
SEA DOO				SXT1100 AR230 H.O. Eng 1	998	2008-09	KN-204
GTX 4-Tec	1484	2002-04	KN-556	SXT1100 SR230/SX230 H.O.	998	2007	KN-303
150 Speedster	1494	2009	KN-556	SXT1100 SX230 H.O.	998	2008-09	KN-204
180 Challenger	1494	2009	KN-556	VX1100 WaveRunner	998	2005-07	KN-303
200 Speedster 430HP	1494	2009	KN-556	VX1100 WaveRunner	998	2008	KN-204
205 Utopia SE	1494	2009	KN-556	SRT1000 AR230	1000	2006	KN-303
230 Challenger/Wake	1494	2007-08	KN-556	SXT1100 232 Limited S	1100	2009	KN-204
GTI 130, 155, Limited, SE, STD	1494	2006-15	KN-556	VX1100 WaveRunner	1100	2009-15	KN-204
GTX	1494	2003-13	KN-556	GX1800 FZR	1800	2011	KN-204

HIGH FLOW AIR FILTERS™

SPECIALTY CLAMP-ON AIR FILTERS FOR SNOWMOBILES

K&N® clamp-on racing filters provide the added airflow your sled needs to perform even better.

- Pleated media offers a large surface area for low restriction, resulting in improved throttle response
- Constructed with ultra-strong molded pliable rubber flanges which absorb vibration and allow for secure attachment
- Flanges can be stretched up to 1/16" (1.5mm) to fit in-between sizes
- K&N® Snowcharger® filter wrap available for use in extreme conditions



Legal in California only for racing vehicles which may never be used, registered or licensed upon a highway.



PLEATED DESIGN



MOLDED RUBBER FLANGE



**SNOWCHARGER®
INSTALLED**

CLAMP-ON SNOWMOBILE AIR FILTERS - See page 272 for additional product listings

MOUNTING FLANGE	INSIDE DIAMETER	FILTER BASE SIZE	FILTER TOP SIZE	FILTER LENGTH	FLANGE ANGLE	PART #	SNOWCHARGER PART #
2 7/16"	3 3/4"	3"	6"	20°	SN-2510	SN-2510PK	
	3 3/4"	3"	5"	20°	SN-2520	SN-2520PK	
	3 3/4"	3"	4"	20°	SN-2530	SN-2530PK	
	3 3/4" x 4"	3 1/2" x 2 1/2"	5"	20°	SN-2540	SN-2540PK	
	3 3/4" x 4"	3 1/2" x 2 1/2"	6"	20°	SN-2550	SN-2550PK	
	3 3/4" x 4"	3 1/2" x 2 1/2"	7"	20°	SN-2560	SN-2560DK	
2 3/4"	3 1/2"	2"	5"	•	SN-2570	SN-2570PK	
	4 1/2"	3"	4"	•	SN-2580	SN-2580PK	
	4"	3"	5"	10°	SN-2590	SN-2590PK	
	4"	3"	6"	10°	SN-2600	SN-2620PK	
	4"	3"	6"	20°	SN-2620	SN-2620PK	

Mikuni VM30-34 carburetors use filters with a 2 1/4" I.D. flange. Mikuni VM36-38 carburetors use filters with a 2 7/16" I.D. flange. Mikuni VM40-44 carburetors use filters with a 2 3/4" I.D. flange.

PERFORMANCE OIL FILTERS FOR SNOWMOBILES



Designed to be compatible with both of today's premium synthetic and traditional style oils, the affixed 17mm hex nut can allow for quick and easy oil changes inside a hard to reach engine compartment.

- 17mm hex nut for easy wrench-off*
- Pre-drilled for safety wire attachment*
- Premium synthetic blend media provides outstanding filtration at high flow rates
- High-performance anti-drainback valve*
- Heavy duty canister construction

*Where applicable



SNOWMOBILE OIL FILTERS - Visit knfilters.com for additional product listings

POLARIS	SIZE	YEAR	PART #	YAMAHA CONTINUED	SIZE	YEAR	PART #
Frontier Classic	684	2003-04	KN-196	RS90LTGT Vector LTX GT	973	2008-14	KN-147
Frontier Classic/Touring	784	2003-05	KN-196	RS90R RS Vector ER	973	2009-09	KN-147
SKI DOO				RST90 RS Venture	973	2010-16	KN-147
Expedition Sport TUV V-800	799	2007-08	KN-152	VK10 RS Viking Professional	973	2008-16	KN-147
Legend Touring V-800	800	2007-09	KN-152	RX10GT Apex GT	977	2006-10	KN-204
Legend Trail V-800	800	2007-08	KN-152	RX10M Apex Mountain	977	2006-07	KN-204
Skandic V-800 SWT	806	2007-09	KN-152	RXW10 Attak	977	2006-07	KN-204
Skandic V-800 Tundra	806	2007-07	KN-152	FX10 Nytro	998	2008-13	KN-147
Expedition TUV V-1000	1000	2005-06	KN-556	FX10MT Nytro MTX	998	2008-10	KN-147
Legend V-1000 GT SE SPORT	1000	2004-05	KN-556	FX10RTR Nytro RTX	998	2008-10	KN-147
YAMAHA				RX10PS Apex SE	998	2011-15	KN-204
PZ50GT Phazer GT	499	2007-14	KN-147	RX10PX Apex XTX	998	2011-16	KN-204
PZ50MT Phazer Mountain Lite	499	2007-07	KN-147	RX10R Apex	998	2008-14	KN-204
PZ50MT Phazer MTX	499	2008-16	KN-147	RX10R Apex ER	998	2006-07	KN-204
PZ50RTX Phazer RTX	499	2008-16	KN-147	RX10 RX-1	1000	2003-05	KN-303
PZ50VT Venture Lite	499	2007-14	KN-147	RX10LT Apex LTX	1000	2008-10	KN-204
PZ50XT Phazer XTX	499	2014-16	KN-147	RX10LTGT Apex LTX GT	1000	2008-10	KN-204
RPZ50 Venture MP	499	2013-15	KN-147	RX10LTGTA Apex LTX GT 40th Anniv	1000	2008-08	KN-204
PZ50 Phazer	500	2007-09	KN-147	RX10M RX-1 Mountain	1000	2005-05	KN-303
RS90M RS Vector Mountain	953	2005-07	KN-147	RX10MS Apex Mountain SE	1000	2007-07	KN-204
RS90N Nytro	953	2006-07	KN-147	RX10MT Apex MTX	1000	2008-10	KN-204
RS90R RS Vector ER	953	2005-07	KN-147	RX10RS RX-1 ER LE	1000	2003-05	KN-303
RSG90 RS Rage	953	2005-07	KN-147	FX10M FX Nytro MTX 153	1049	2011-14	KN-147
RST90 RS Venture GT	953	2005-14	KN-147	FX10M FX Nytro MTX 162	1049	2011-14	KN-147
VK10 VK Professional	953	2006-07	KN-147	FX10RTR Nytro RTX	1049	2011-13	KN-147
RS90 RS Vector	973	2006-08	KN-147	FX10XT FX Nytro XTX 1.75	1049	2013-14	KN-147
RS90GT Vector GT	973	2008-11	KN-147	FX10XT Nytro XTX	1049	2009-12	KN-147
RS90GT Vector GT	973	2013-13	KN-147	RS10 RS Venture TF	1049	2013-14	KN-147
RS90LT Vector LTX	973	2008-09	KN-147	RS90LTGT Vector LTX GT	1049	2011-14	KN-147
				SR Viper LTX RTX XTX SE	1049	2014	KN-147



SPECIALTY / ACCESSORIES

SPECIALTY / WRAPS / OTHER PRODUCTS

SPECIALTY AIR FILTERS

- Designed to clamp on to different sized intake tubes, velocity stacks, carburetors or throttle bodies
- Many applications available depending on diameter, angle or offset
- Designed to provide added airflow for your bike for increased performance
- Pleated media offers a large surface area, resulting in low restriction and excellent throttle response
- Constructed with ultra-strong molded pliable rubber flanges which absorb vibration and allow for secure attachment



AIR FILTER WRAPS

- Designed to offer added protection from wet weather, extreme elements and extended service intervals compared to exposed air filters
- Stops small dirt particles yet adds little restriction to the airflow of the filter
- Available in many different sizes and a variety of colors of universal or custom fit applications
- Made from durable, specially treated polyester micro-weave material containing uniform micron openings
- Designed to be run dry and can be cleaned with K&N® POWER KLEEN®
- Double-stitched elastic openings ensure proper fitment



OTHER PRODUCTS FOR SPECIALTY VEHICLES

KART AIRBOXES AND AIR FILTERS



CRANKCASE VENT BREATHERS



ACCESSORIES



Legal in California only for racing vehicles which may never be used, registered or licensed for use upon a highway.

SPECIALTY AIR FILTERS

DESIGNED TO INCREASE HORSEPOWER

CARBON FIBER TOP SPECIALTY AIR FILTERS

Carbon fiber provides incredible strength with minimal weight. Carbon fiber provides 1/3 less weight than conventional filter top construction material. Smooth, glass-like finish provides the ultimate in fit and finish as well as function and performance.

**CARBON FIBER TOP AIR FILTERS HAVE
PART NUMBERS THAT BEGIN WITH "RP" OR "RF"**

PRODUCT LISTINGS CAN BE FOUND ON PAGES 272-289



TITANIUM TOP SPECIALTY AIR FILTERS

When it comes to exotic race materials, titanium is well known for its lightweight and increased strength to weight ratio.

**TITANIUM TOP AIR FILTERS HAVE
PART NUMBERS THAT BEGIN WITH "RT"**

PRODUCT LISTINGS CAN BE FOUND ON PAGES 272-289



XSTREAM® TOP SPECIALTY AIR FILTERS

K&N® patented Xstream® racing air filters take performance to the next level with innovative K&N® airflow technology. Xstream® air filters provide outstanding airflow and increased filtration area over a standard K&N® air filter. Standard tapered or reversed tapered styles available.

K&N® XStream® Series Air Filter. U.S. Patent Number: D401,597

**XSTREAM® TOP AIR FILTERS HAVE
PART NUMBERS THAT BEGIN WITH "RX"**

PRODUCT LISTINGS CAN BE FOUND ON PAGES 272-289



INVERTED TOP SPECIALTY AIR FILTERS

A unique approach to filter design and concept, with a filter top that actually inverts, dropping into the cylinder of the filter. Surface area is greatly increased and designed to provide more filtration than any other comparably sized product. With three color choices, you can now customize your intake.

**INVERTED TOP AIR FILTERS HAVE
PART NUMBERS THAT BEGIN WITH "RR" OR "RG"**

PRODUCT LISTINGS CAN BE FOUND ON PAGES 272-289

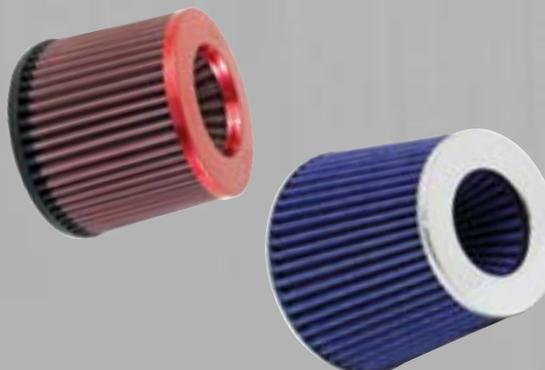

These products are not street legal on vehicles with regulated emission control systems unless used as a direct replacement air filter for a street legal intake system

AIR FILTER WRAPS FOR ADDED PROTECTION

PRECHARGER® AIR FILTER WRAPS

K&N® Prechargers® are a specially designed filter wrap made to extend the service interval of your K&N® air filter when used in very dusty conditions.

- Made from durable polyester micro-weave material containing uniform micron openings
- Stops small dirt particles, yet adds little restriction to the airflow of the filter
- Designed to be run dry and can be cleaned with K&N® filter cleaner
- Double stitched elastic openings assure that the Precharger® will stay in place
- Custom made to fit each application and available in a variety of colors



DRYCHARGER® AIR FILTER WRAPS

K&N® Drychargers® are designed to prevent splashes of water or mud from saturating your K&N® air filter.

- Fits and functions exactly the same as the K&N® Precharger® except for being pre-treated with a proprietary hydrophobic process
- Manufactured from a durable polyester micro-weave material
- Stops small dirt particles, yet adds little restriction to the airflow of the filter
- Please be aware the Drycharger® is water repellent, not waterproof and depending on conditions as well as usage the water repellent treatment is good for 1 to 2 years



PRE-CLEANER AIR FILTER WRAPS

Developed for only the dustiest of conditions, the K&N® pre-cleaner is a specially designed foam filter wrap made to extend the service interval of your K&N® air filter. Made from large, open cell foam, the pre-cleaner will trap dust and dirt, yet add only a small amount of restriction to the airflow of your filter.

- Custom made to fit specific applications
- Also sold in universal cut-to-fit sizes
- Red pre-cleaners are designed to be used with foam filter oil (purchased locally), pre-cleaners must be cleaned with K&N® cleaner or soap and water



AMERICAN V-TWIN

STREET

OFF-ROAD

WATERCRAFT/SNOW

SPECIALTY/
ACCESSORIES

HAULER HORSEPOWER

APPAREL/SIGNAGE

K&N® PRODUCT LISTINGS

CRANKCASE VENT BREATHERS

MULTIPLE STYLES AND SIZES AVAILABLE

Steel base crankcase vent filters have vent tubes added to their base. Filters consist of a one piece design with a rubber or chrome top. Filters with mounting studs can be mounted remotely, but require vent hoses and clamps. Filters mounted direct can be pressed into rubber grommets in valve covers. Base plates are chrome plated with zinc tubes.

Rubber base crankcase vent filters are designed to clamp directly to metal or plastic tubing, or to push into rubber breather grommets. Ideal for engines, transmissions, oil and gas tanks on racing vehicles. Metal shields and top plates are chrome plated for beauty and durability.

 #62-1090 installed with stud mount



**CHROME PLATED BASE
PLATE WITH ZINC TUBE**



**CLAMP-ON
RUBBER FLANGE**



**#62-1600 AVAILABLE IN
MULTIPLE COLORS¹**

CRANKCASE VENT BREATHERS - Visit knfilters.com for additional product listings

FLANGE I.D. (RUBBER BASE)	DIAMETER	HEIGHT	RUBBER	CHROME	CARBON FIBER
3/8" or 1/2"	2"	1 3/4"	•	62-1600 ¹	•
1/2"	2"	1 1/2"	•	62-1330	•
5/8"	2"	1 1/2"	•	62-1340	•
3/4"	2"	1 1/2"	•	62-1360	•
1"	2"	1 1/2"	•	62-1370	•
1" Push-On	2"	1 1/2"	•	62-1220	•
FLANGE O.D. (STEEL BASE)	DIAMETER	HEIGHT	RUBBER	CHROME	CHROME W/STUD
3/8"	2"	1 1/2"	62-1000	•	62-1090
1/2"	2"	1 1/2"	62-1010	62-1015	62-1100
1/2"	2"	3"	62-1250	•	62-1300
1/2"	3"	2"	62-1050	62-1140	•
5/8"	2"	1 1/2"	62-1020	•	62-1110
3/4"	2"	1 1/2"	62-1030	•	62-1120

1) Available in three colors. Add "BL" to end of part number for blue, "RD" for red, or "WT" for white

Legal in California only for racing vehicles which may never be used, registered or licensed for use upon a highway. These filters are not applicable, nor intended for use on aircraft. CAUTION: The use of these atmosphere vented breather systems are not recommended for computer controlled vehicles, as it will result in erratic operation and damage to the engine.

ACCESSORIES

FUEL FILTERS/ADAPTORS/WASHERS/ETC.

IN-LINE FUEL FILTERS

5/32" FLANGES

1 3/16" body dia. by 2 3/16" overall length (1 1/4" filter body length). Nylon mesh filter element.

DESCRIPTION

Single pack

12 pack

PART

81-0291

81-0290

PART NUMBER
81-0291



1/4" FLANGES

5/8" body dia. by 2 1/8" overall length (1 5/16" filter body length). Sintered brass filter element.

DESCRIPTION

Single pack

12 pack

PART

81-0221

81-0220

PART NUMBER
81-0221



1/4" FLANGES

1 5/16" body dia. by 1 3/4" overall length (3/4" filter body length). Stainless steel mesh filter element.

DESCRIPTION

Single pack

12 pack

PART

81-0231

81-0230

PART NUMBER
81-0231

5/16" FLANGES

1 1/2" body dia. by 1 3/4" overall length (3/4" filter body length). Stainless steel mesh filter element.

DESCRIPTION

Single pack

12 pack

PART

81-0241

81-0240

PART NUMBER
81-0241

5/16" FLANGES

1 5/16" body dia. by 2 1/8" overall length (1 1/4" filter body length). Polymer treated paper filter element.

DESCRIPTION

Single pack

PART

81-0261

PART NUMBER
81-0261

FUEL LINE "T" FITTING

High flow, durable, lightweight, easy to use. One size fits 1/4" to 3/8" I.D. hose.

DESCRIPTION

Packed 12 per card

Packed 1 per card

PART#

81-0270

81-0271

PART NUMBER
81-0271



VELOCITY STACK AIR FILTER ADAPTOR

Lightweight nylon 6/6 construction. Fits 41mm Keihin CR flat slide carbs.

DESCRIPTION

53mm Long - Uses any 2 7/16" Flange K&N Air Filter

PART#

85-3000

PART NUMBER
85-3000



REINFORCED RUBBER WASHERS

The answer to mechanical vibrations. Made of 1/8" thick reinforced neoprene rubber. Ideal for thin panels, fenders, number plates, air cleaner lids and other items that need to be rubber mounted.

DESCRIPTION

1) 1" O.D., 1/4" hole (12 - 10 packs per card)

1) 1" O.D., 1/4" hole (single 10 pack)

2) 1 1/4" O.D., 5/16" hole (12 - 8 packs per card)

2) 1 1/4" O.D., 5/16" hole (single 8 pack)

PART#

81-0150

81-0151

81-0160

81-0161



PART NUMBER
81-0151

PART NUMBER
81-0161

PERFORMANCE AIR BOX FOR KARTS

Since more & more kart racing organizations like IKF & SKUSA require the use of an air box/silencer, K&N® now offers a high-flow air box specifically built for karting that accommodates an original K&N® washable High-Flow Air Filter™.

- K&N® High-Flow Air Filters™ & kart air box/silencer are ideal for both 2- or 4-cycle karts
- K&N® kart air box encases a 2 1/2" (inside diameter) straight or 20° angled flange High-Flow Air Filter™
- Brass threaded insert built in to the end eases mounting
- Comes equipped with 23mm restrictors but 29mm restrictors are also available
- Approved by most kart racing organizations

Legal in California only for racing vehicles which may never be used, registered or licensed upon a highway.



**STRAIGHT OR 20°
ANGLED FLANGE**



**DURABLE ROTO-MOLDED
AIR BOX**



**23MM OR 29MM
RESTRICTORS**

KART PERFORMANCE AIR BOX

DESCRIPTION	PART #
Air box with 23mm I.D. restrictors	RK-1000
High-Flow Air Filter™ - Straight	RU-5005
High-Flow Air Filter™ - 20° Angled	RU-5006
29 mm I.D. restrictors	85-2000
23 mm I.D. restrictors	85-2001



HIGH-FLOW AIR FILTERS™ FOR KARTS

Alden Racing - Danny Alden



Clamp-on specialty filters are designed to provide added airflow for your kart.

- Pleated media offers a large surface area for low restriction, resulting in improved throttle response
- Constructed with ultra-strong molded pliable rubber

flanges which absorb vibration and allow for secure attachment

- Flanges can be stretched up to 1/16" (1.5mm) to fit in-between sizes
- K&N® Precharger® filter wrap available to extend service intervals



CLAMP-ON KART AIR FILTERS

REPLACEMENT AIR FILTERS FOR HONDA GX-160 KART ENGINE

DESCRIPTION	AIR FILTER #
Replaces Honda OE part #17210-ZEI-822	HA-0201

1 11/16" FLANGE MOUNT

MOUNTING FLANGE	DIAMETER/LENGTH	AIR FILTER #	PRECHARGER® #
Centered, round	3"D x 4"	RU-0200	22-8009PK
Centered, round	4"D x 2"	RU-0260	•

2 1/16" FLANGE MOUNT

MOUNTING FLANGE	DIAMETER/LENGTH	AIR FILTER #	PRECHARGER® #
Centered, round	3 1/2"D x 4"	RU-0500	RU-0500PK
Centered, round	3 1/2"D x 6"	RU-0520	RU-0520PK
Centered, tapered	3 1/2"-2"D x 4"	RC-1200	RC-1200PK

2 7/16" FLANGE MOUNT

MOUNTING FLANGE	DIAMETER/LENGTH	AIR FILTER #	PRECHARGER® #
Centered, round	3 1/2"D x 4"	RU-0800	RU-0500PK
Centered, round	3 1/2"D x 6"	RU-0820	RU-0520PK
20° angle, round	3 3/4"D x 4"	RU-1750	22-8011PK
20° angle, round	3 3/4"D x 6"	RU-1770	RU-1470PK
Centered, round	4 1/2"D x 4"	RU-0830	22-8012PK
Centered, tapered	4 1/2"D x 5"	RU-0840	22-8013PK
Offset, tapered	5 1/2-4 1/2"D (top) x 4"	R-1380	•
20° angle, oval	4 1/2"-3 3/4"D x 7"	RU-1390	RU-1240PK

2 3/4" FLANGE MOUNT

MOUNTING FLANGE	DIAMETER/LENGTH	AIR FILTER #	PRECHARGER® #
10° angle, round	4"D x 5"	RU-1460	RU-1460PK
Centered, round	4 1/2"D x 4"	RU-0900	22-8012PK
Centered, oval	6 1/4"-4"D x 5"	RU-1500	•

KART AIR BOX ADAPTER

DESCRIPTION	PART #
Air filter with stainless steel end cap	RC-5004
Air filter with rubber end cap	RU-5004
Adapter for spec plenum air box silencer	85-8851

PART NUMBER
RC-5004

Stainless Steel



PART NUMBER
85-8851

Adapter



Legal in California only for racing vehicles which may never be used, registered or licensed upon a highway.



HAULER HORSEPOWER

HIGH-FLOW AIR FILTERS™

- Designed to increase horsepower & acceleration
 - Never needs to be replaced
 - Washable and reusable
 - 10-year/million mile limited warranty
- for details, visit knfilters.com/warranty

WASHABLE
REUSABLE
PERFORMANCE®



for details, visit
knfilters.com/warranty



PERFORMANCE INTAKE SYSTEMS†

- Guaranteed increase in horsepower
 - Improved throttle response
 - Better engine sound
 - Installs easily, usually in 90 minutes or less
 - Black HDPE or mirror-finish aluminum intake tube*
 - 10-year/million mile limited warranty
 - Won't void factory warranty
- for details, visit knfilters.com/warranty

*where applicable

†

SOME INTAKE SYSTEMS ARE NOT LEGAL FOR SALE OR USE ON ANY POLLUTION CONTROLLED MOTOR VEHICLE IN CALIFORNIA OR STATES ADOPTING CALIFORNIA EMISSION PROCEDURES.

See knfilters.com for CARB status on each part for a specific vehicle



See knfilters.com for specifications regarding emissions standards and CARB regulations.

WRENCH-OFF® OIL FILTERS

- Welded 1" filter nut eases removal
- High flow and high filtration
- Designed to be compatible with synthetic motor oils
- Heavy duty canister construction
- K&N® Limited Warranty

for details, visit knfilters.com/warranty



PERFORMANCE INTAKE SYSTEMS FOR AUTOMOBILES

- Guaranteed to increase horsepower
- Washable and reusable cotton High-Flow Air Filter™
- Better engine sound
- Easy to install in 90 minutes or less
- Oversized air filter can go up to 100,000 miles between cleanings (under normal highway driving conditions)
- 10-year/million mile limited warranty
for details, visit knfilters.com/warranty



SOME INTAKE SYSTEMS ARE NOT LEGAL FOR SALE OR USE ON ANY POLLUTION CONTROLLED MOTOR VEHICLE IN CALIFORNIA OR STATES ADOPTING CALIFORNIA EMISSION PROCEDURES.
See knfilters.com for CARB status on each part for a specific vehicle

See knfilters.com for specifications regarding emissions standards and CARB regulations.



**OVERSIZED WASHABLE
HIGH-FLOW AIR FILTER™**



**VEHICLE-SPECIFIC
TUBE AND HEAT SHIELD**
(where applicable)



**MULTIPLE FINISHES
AVAILABLE**

BLACKHAWK INDUCTION™ SYSTEMS

Our NEW blacked out intake systems give you a stealth look along with the added performance and killer sound that comes with traditional K&N® intakes.

Guaranteed to increase horsepower

Black powder-coated aluminum heat shield to isolate incoming air from engine heat and mandrel-bent high-flow aluminum intake tube

Featuring NEW black synthetic washable air filters:

- Incredibly easy to clean – uses no oil
- Thick 3D media provides high airflow and dirt capacity



Some intake systems are not legal for sale or use on any pollution controlled motor vehicle in California or states adopting California emission procedures.

VISIT KNFILTERS.COM FOR COMPLETE PRODUCT LISTINGS

PERFORMANCE INTAKE SYSTEMS FOR AUTOMOBILES

HIGH-FLOW INTAKE SYSTEMS - Visit knfilters.com for additional product listings

CHEVROLET	YEAR	ENGINE (LITERS)	BLACK HDPE INTAKE TUBE	NOTE	EST. HP GAIN†	ALUMINUM INTAKE TUBE	NOTE	EST. HP GAIN†
Avalanche	2009-13	5.3L	57-3070	1	+ 10 hp	77-3070KP	1	+ 10 hp
Colorado	2007-12	2.9L	63-3064-1	2	+ 9 hp	•	•	•
Colorado	2007-12	3.7L	63-3065	2	+ 11 hp	77-3065KP	2	+ 7 hp
Colorado	2015-16	3.6L	63-3088	2	+ 19 hp	77-3088KP	2	+ 10 hp
Silverado 1500/Colorado	2014	4.3L	63-3085	2	+ 10 hp	77-3085KP	2	+ 10 hp
Silverado 1500	2014-17	5.3L	63-3082	2	+ 11 hp	77-3082KP	2	+ 10 hp
Silverado 1500	2014-16	6.2L	63-3082	2	+ 11 hp	77-3082KP	2	+ 10 hp
Silverado 1500	2012-13	4.8L	63-3070	2	+ 10 hp	77-3070KP	2	+ 10 hp
Silverado 1500	2012-13	5.3L	63-3070	2	+ 10 hp	77-3070KP	2	+ 10 hp
Silverado 1500	2009-11	4.8L	63-3070	2	+ 10 hp	77-3070KP	1	+ 10 hp
Silverado 1500	2009-11	5.3L	63-3070	2	+ 10 hp	77-3070KP	1	+ 10 hp
Silverado 1500	2007-08	4.8L	57-3058	1	+ 18 hp	77-3058KP	1	+ 12 hp
Silverado 1500	2007-08	5.3L	57-3058	1	+ 18 hp	77-3058KP	1	+ 12 hp
Silverado 1500	1999-06	4.3L	57-3038	1	+ 8 hp	•	•	•
Silverado 1500	2005-06	4.8L	57-3050	1	+ 12 hp	77-3050KP	1	+ 8 hp
Silverado 1500	2005-06	5.3L	57-3050	1	+ 12 hp	77-3050KP	1	+ 8 hp
Silverado 1500	1999-04	4.8L	57-3021-1	1	+ 9 hp	77-3021KP	1	+ 8 hp
Silverado 1500	1999-04	5.3L	57-3021-1	1	+ 9 hp	77-3021KP	1	+ 8 hp
Silverado 1500 Classic	2007	4.3L	57-3038	1	+ 8 hp	•	•	•
Silverado 1500 Classic	2007	4.8L	57-3050	1	+ 12 hp	77-3050KP	1	+ 8 hp
Silverado 1500 Classic	2007	5.3L	57-3050	1	+ 12 hp	77-3050KP	1	+ 8 hp
Silverado 2500/3500 HD	2015-16	6.6L DSL	63-3087	2	+ 24 hp	77-3087KP	2	+ 20 hp
Silverado 2500/3500 HD	2011-14	6.6L DSL	57-3077	1	+ 19 hp	77-3077KP	1	+ 12 hp
Silverado 2500 HD	2016	6.0L DSL	•	•	•	77-3090KTK	2	+ 7 hp
Silverado 2500 HD	2007-10	6.6L DSL	57-3066	1	+ 20 hp	•	•	•
Silverado 2500 HD	2001-06	8.1L	57-3030-1	1	+ 17 hp	•	•	•
Silverado 2500 HD	2006	6.6L DSL	57-3000	1	+ 15 hp	•	•	•
Silverado 2500 HD	2005	6.6L DSL	57-3000	1,3	+ 15 hp	•	•	•
Silverado 2500 HD	2005	6.6L DSL	57-3047	1,4	+ 20 hp	77-3047KP	1,4	+ 20 hp
Silverado 2500 HD	2004	6.6L DSL	57-3034	1,5	+ 16 hp	77-3034KP	1,5	+ 13 hp
Silverado 2500 HD	2004	6.6L DSL	57-3047	1,6	+ 20 hp	77-3047KP	1,6	+ 20 hp
Silverado 2500 HD	2001-03	6.6L	57-3034	1	+ 16 hp	77-3034KP	1	+ 13 hp
Silverado 2500 HD Classic	2007	6.6L DSL	57-3000	1	+ 15 hp	•	•	•
Silverado 3500	2006	6.6L DSL	57-3000	1	+ 15 hp	•	•	•
Silverado 3500	2005	6.6L DSL	57-3000	1,3	+ 15 hp	•	•	•
Silverado 3500	2005	6.6L DSL	57-3047	1,4	+ 20 hp	77-3047KP	1,4	+ 20 hp
Silverado 3500	2004	6.6L DSL	57-3034	1,5	+ 16 hp	77-3034KP	1,5	+ 13 hp
Silverado 3500	2004	6.6L DSL	57-3047	1,6	+ 20 hp	77-3047KP	1,6	+ 20 hp
Silverado 3500	2001-03	6.6L DSL	57-3034	1	+ 16 hp	77-3034KP	1	+ 13 hp
Silverado 3500 Classic	2007	6.6L DSL	57-3000	1	+ 15 hp	•	•	•
Silverado 3500 HD	2007-10	6.6L DSL	57-3066	1	+ 20 hp	•	•	•
Silverado 3500	2016	6.0L DSL	•	•	•	77-3090KTK	2	+ 7 hp
Suburban 1500	2009-14	5.3L	57-3070	1	+ 10 hp	77-3070KP	1	+ 10 hp
Suburban 1500	2015-17	5.3L	63-3082	2	+ 11 hp	77-3082KP	2	+ 12 hp
Tahoe	2015-17	5.3L	63-3082	2	+ 11 hp	77-3082KP	2	+ 10 hp
Tahoe	2009-14	5.3L	57-3070	1	+ 10 hp	77-3070KP	1	+ 10 hp
Tahoe	2007-08	5.3L	57-3058	1	+ 18 hp	77-3058KP	1	+ 12 hp
Tahoe	2005-06	5.3L	57-3050	1	+ 12 hp	77-3050KP	1	+ 8 hp
Tahoe	2000-04	5.3L	57-3023-1	1	+ 14 hp	77-3023KP	1	+ 8 hp
DODGE								
Durango	2011-15	3.6L	•	•	•	77-1560KTK	2	+ 11 hp
Durango	2011-17	5.7L	63-1563	2	+ 17 hp	77-1563KP	2	+ 15 hp
Ram 1500 Pickup	2002-10	3.7L	57-1537	1	+ 7 hp	•	•	•
Ram 1500 Pickup	2002-10	4.7L	57-1529	1	+ 9 hp	77-1529KP	1	+ 7 hp
Ram 1500 Pickup	2009-11	5.7L	57-1561	1	+ 16 hp	77-1561KP	1	+ 10 hp
Ram 1500 Pickup	2003-08	5.7L	57-1533	1	+ 10 hp	77-1533KP	1	+ 8 hp
Ram 1500 Pickup	2002-03	5.9L	57-1530-1	1	+ 9 hp	•	•	•
Ram 2500 Pickup	2010	6.7L DSL	63-1562	2	+ 8 hp	•	•	•
Ram 2500 Pickup	2007-09	6.7L DSL	57-1557	1	+ 21 hp	•	•	•

1) Street Legal in 50 States 2) Street Legal in most states, not legal for sale or use in California or other states with similar emission control regulations 3) w/Round Filter 4) w/Panel Filter 5) LB7 6) LLY 7) Exc. 2 Valve VIN W NOTE: Prefix 57 and 63 usually incorporate black molded high density polyethylene tubes. Prefix 69 and 77 incorporate aluminum tubes. †Estimated horsepower and torque gains based on specific or similar vehicle dynamometer tests. Results will vary. Visit knfilters.com for specifications regarding emissions standards and CARB regulations and additional testing and estimated horsepower information.

PERFORMANCE INTAKE SYSTEMS FOR AUTOMOBILES

HIGH-FLOW INTAKE SYSTEMS - Visit knfilters.com for additional product listings

DODGE CONTINUED	YEAR	ENGINE (LITERS)	BLACK HDPE INTAKE TUBE	NOTE	EST. HP GAIN†	ALUMINUM INTAKE TUBE	NOTE	EST. HP GAIN†
Ram 2500/3500 Pickup	1994-02	5.9L DSL	57-1525	1	+ 9 hp	•	•	•
Ram 3500 Pickup	2010	6.7L DSL	63-1562	2	+ 8 hp	•	•	•
Ram 3500 Pickup	2007-09	6.7L DSL	57-1557	1	+ 21 hp	•	•	•
Ram 3500 Pickup	2003-08	5.7L	57-1533	1	+ 10 hp	77-1533KP	1	+ 8 hp
Ram 3500 Pickup	2003-07	5.9L DSL	57-1532	1	+ 11 hp	•	•	•
FORD								
Expedition	2015-17	3.5L ECO	63-2595	2	+ 7 hp	•	•	•
Expedition	2011-14	5.4L	63-2575	2	+ 11 hp	•	•	•
Expedition	2007-10	5.4L	57-2575	1	+ 11 hp	•	•	•
Explorer	2014-15	2.0L	•	•	•	77-2587KS	2	+ 11 h
F150	2015	5.0L	57-2591	1	+ 13 hp	77-2591KP	1	+ 14 hp
F150	2015-16	2.7L	63-2593	1	+ 19 hp	•	•	•
F150 EcoBoost	2015-16	3.5L	63-2592	2	+ 23 hp	•	•	•
F150	2015-16	3.5L exc turbo	63-2596	2	+12 hp	•	•	•
F150	2015-16	3.5L	63-2592	2	+ 23 hp	•	•	•
F150	2011-14	3.5L	57-2583	1	+ 11 hp	•	•	•
F150	2011-14	5.0L	57-2581	1	+ 12 hp	77-2581KP	1	+ 10 hp
F150	2012-14	3.7L	•	•	•	77-2585KS	2	+ 12 hp
F150	2011-12	6.2L	57-2584	1	+ 27 hp	77-2584KP	1	+ 19 hp
F150	2009-10	5.4L	57-2575	1	+ 11 hp	•	•	•
F150	2009-10	4.6L	63-2580	1,7	+ 16 hp	77-2580KP	1,7	+ 15 hp
F150	2004-08	5.4L	57-2556	1	+ 15 hp	77-2556KP	1	+ 10 hp
F150	2007-08	4.6L	57-2574	1	+ 10 hp	•	•	•
F150	2004-05	4.6L	57-2557	1	+ 8 hp	77-2557KP	1	+ 9 hp
F150	1997-04	4.2L	57-2550	1	+ 8 hp	77-2550KP	1	+ 6 hp
F150	1997-03	4.6L/5.4L	57-2541	1	+ 13 hp	77-2514KP	1	+ 10 hp
F150 Harley Davidson	2002-03	5.4L	57-2549	1	+ 16 hp	•	•	•
F150 Harley Davidson	2000-01	5.4L	57-2514-4	1	+ 10 hp	77-2514KP	1	+ 10 hp
F150 Heritage	2004	5.4L	57-2541	1	+ 13 hp	•	•	•
F150 Heritage	2004	4.6L	57-2541	1	+ 13 hp	77-2514KP	1	+ 10 hp
F150 SVT Raptor	2010-14	6.2L	•	•	•	77-2579KTK	2	+ 20 hp
F150 SVT Raptor	2010	5.4L	57-2575	1	+ 11 hp	•	•	•
F250/350 Super Duty	2015-16	6.2L	•	•	•	77-2582KTK	2	+ 14 hp
F250/350 Super Duty	2011-14	6.2L	63-2582	1	+ 12 hp	77-2582KTK	1	+ 14 hp
F250 Super Duty	2008-10	6.4L DSL	57-2576	1	+ 16 hp	•	•	•
F250 Super Duty	2003-07	6.0L DSL	57-2546-1	1	+ 16 hp	•	•	•
F250 Super Duty	2000-03	7.3L DSL	57-2530	1	+ 15 hp	•	•	•
F350 Super Duty	2008-10	6.4L DSL	57-2576	1	+ 16 hp	•	•	•
F350 Super Duty	2003-07	6.0L DSL	57-2546-1	1	+ 16 hp	•	•	•
F350 Super Duty	2000-03	7.3L DSL	57-2530	1	+ 15 hp	•	•	•
Ranger	2004-11	4.0L	57-2561	1	+ 13 hp	77-2561KP	1	+ 11 hp
Ranger	2004-08	3.0L	57-2560	1	+ 10 hp	•	•	•
GMC								
Canyon	2015-16	2.5L	63-3089	2	+9 hp	77-3089KP	2	+ 12 hp
Canyon	2015-16	3.6L	63-3088	2	+ 19 hp	77-3088KP	2	+ 10 hp
Canyon	2007-12	2.9L	63-3064-1	2	+ 9 hp	•	•	•
Canyon	2007-12	3.7L	63-3065	2	+ 11 hp	77-3065KP	2	+ 7 hp
Sierra 1500/Canyon	2014-16	4.3L	63-3085	2	+ 10 hp	77-3085KP	2	+ 10 hp
Sierra 1500	2014-17	5.3L	63-3082	2	+ 11 hp	77-3082KP	2	+ 10 hp
Sierra 1500	2014-17	6.2L	63-3082	2	+ 11 hp	77-3082KP	2	+ 10 hp
Sierra 1500	2014	5.3L/6.2L	57-3082	1	+11 hp	•	•	•
Sierra 1500	2009-13	4.8L	57-3070	1	+ 10 hp	77-3070KP	1	+ 10 hp
Sierra 1500	2009-13	5.3L	57-3070	1	+ 10 hp	77-3070KP	1	+ 10 hp
Sierra 1500	2007-08	4.8L	57-3058	1	+ 18 hp	77-3058KP	1	+ 12 hp
Sierra 1500	2007-08	5.3L	57-3058	1	+ 18 hp	77-3058KP	1	+ 12 hp
Sierra 1500	2005-06	4.8L	57-3050	1	+ 12 hp	77-3050KP	1	+ 8 hp
Sierra 1500	2005-06	5.3L	57-3050	1	+ 12 hp	77-3050KP	1	+ 8 hp
Sierra 1500 Classic	2007	4.8L	57-3050	1	+ 12 hp	77-3050KP	1	+ 8 hp

1) Street Legal in 50 States 2) Street Legal in most states, not legal for sale or use in California or other states with similar emission control regulations
3) w/Round Filter 4) w/Panel Filter 5) LB7 6) LLY 7) Exc. 2 Valve VIN W NOTE: Prefix 57 and 63 usually incorporate black molded high density polyethylene tubes. Prefix 69 and 77 incorporate aluminum tubes. †Estimated horsepower and torque gains based on specific or similar vehicle dynamometer tests. Results will vary. Visit knfilters.com for specifications regarding emissions standards and CARB regulations and additional testing and estimated horsepower information.

PERFORMANCE INTAKE SYSTEMS FOR AUTOMOBILES

HIGH-FLOW INTAKE SYSTEMS - Visit knfilters.com for additional product listings

GMC CONTINUED	YEAR	ENGINE (LITERS)	BLACK HDPE INTAKE TUBE	NOTE	EST. HP GAIN†	ALUMINUM INTAKE TUBE	NOTE	EST. HP GAIN†
Sierra 1500 Classic	2007	5.3L	57-3050	1	+ 12 hp	77-3050KP	1	+ 8 hp
Sierra 2500/3500 HD	2015-16	6.6L DSL	63-3087	2	+ 24 hp	77-3087KP	2	+ 20 hp
Sierra 2500/3500HD	2011-14	6.6L DSL	57-3077	1	+ 19 hp	77-3077KP	1	+ 12 hp
Sierra 2500 HD	2007-10	6.6L DSL	57-3066	1	+ 20 hp	•	•	•
Sierra 2500 HD	2001-06	8.1L	57-3030-1	1	+ 17 hp	•	•	•
Sierra 2500 HD	2006	6.6L DSL	57-3000	1	+ 15 hp	•	•	•
Sierra 2500 HD	2005	6.6L DSL	57-3000	1,3	+ 15 hp	•	•	•
Sierra 2500 HD	2005	6.6L DSL	57-3047	1,4	+ 20 hp	77-3047KP	1,4	+ 20 hp
Sierra 2500 HD	2004	6.6L DSL	57-3034	1,5	+ 16 hp	77-3034KP	1,5	+ 13 hp
Sierra 2500 HD	2004	6.6L DSL	57-3047	1,6	+ 20 hp	77-3047KP	1,6	+ 20 hp
Sierra 2500 HD Classic	2007	6.6L DSL	57-3000	1	+ 15 hp	•	•	•
Sierra 3500	2006	6.6L DSL	57-3000	1	+ 15 hp	•	•	•
Sierra 3500	2005	6.6L DSL	57-3000	1,3	+ 15 hp	•	•	•
Sierra 3500	2005	6.6L DSL	57-3047	1,4	+ 20 hp	77-3047KP	1,4	+ 20 hp
Sierra 3500	2004	6.6L DSL	57-3034	1,5	+ 16 hp	77-3034KP	1,5	+ 13 hp
Sierra 3500	2004	6.6L DSL	57-3047	1,6	+ 20 hp	77-3047KP	1,6	+ 20 hp
Sierra 3500 Classic	2007	6.6L DSL	57-3000	1	+ 15 hp	•	•	•
Sierra 3500 HD	2007-10	6.6L DSL	57-3066	1	+ 20 hp	•	•	•
Yukon	2015-17	5.3L	63-3082	2	+ 11 hp	77-3082KP	2	+ 10 hp
Yukon	2009-14	5.3L	57-3070	1	+ 10 hp	77-3070KP	1	+ 10 hp
Yukon	2007-08	5.3L	57-3058	1	+ 18 hp	77-3058KP	1	+ 12 hp
Yukon	2005-06	5.3L	57-3050	1	+ 12 hp	77-3050KP	1	+ 8 hp
JEEP								
Cherokee	2014-17	3.2L	63-1569	2	+ 8 hp	77-1569KS	2	+ 8 hp
Grand Cherokee	2012-16	6.4L	•	•	•	77-1567KS	2	+ 28 hp
Grand Cherokee	2011-15	3.6L	•	•	•	77-1560KTK	2	+ 11 hp
Grand Cherokee	2011-14	5.7L	63-1563	2	+ 17 hp	77-1563KP	2	+ 15 hp
Grand Cherokee	2005-10	3.7L	57-1545	1	+ 8 hp	77-1545KP	1	+ 7 hp
Wrangler	2012-17	3.6L	63-1566	2	+ 6 hp	77-1566KP	•	•
Wrangler (Snorkel System)	2012-17	3.6L	63-1573	2	•	•	•	•
Wrangler	2007-11	3.8L	57-1553	1	+ 8 hp	77-1553KP	1	+ 8 hp
NISSAN								
Titan	2012-15	5.6L	63-6012	2	+ 11 hp	77-6012KP	2	+ 7 hp
Titan	2004-11	5.6L	57-6012	1	+ 11 hp	77-6012KP	1	+ 7 hp
RAM								
1500	2015-16	3.0L ECODSL	63-1571	2	+ 11 hp	•	•	•
1500	2012-17	5.7L	63-1561	2	+ 16 hp	77-1561KP	2	+ 10 hp
1500	2013	4.7L	•	•	•	77-1571KP	2	+ 10 hp
1500	2012	4.7L	63-1529	2	+ 9 hp	77-1529KP	2	+ 7 hp
1500	2011	4.7L	57-1529	1	+ 9 hp	77-1529KP	1	+ 7 hp
1500	2011	5.7L	63-1561	2	+ 16 hp	77-1561KP	1	+ 10 hp
2500/3500	2013-17	6.7L DSL	63-1568	2	+ 15 hp	•	•	•
2500	2013-17	5.7L	63-1561	2	+ 16 hp	77-1561KP	2	+ 10 hp
2500/3500	2014-16	6.4L	•	•	•	77-1568KTK	2	+ 16 hp
2500/3500	2011-12	6.7L DSL	57-1562	2	+ 8 hp	•	•	•
TOYOTA								
4 Runner	2010-16	4.0L	63-9034	2	+ 12 hp	77-9034KP	2	+ 11 hp
FJ Cruiser	2010-14	4.0L	63-9034	2	+ 12 hp	77-9034KP	2	+ 11 hp
Tacoma	2016-17	3.5L	63-9039	2	+ 17 hp	77-9039KP	2	+ 18 hp
Tacoma	2005-16	2.7L	63-9026	2	+ 7 hp	77-9026KP	2	+ 6 hp
Tacoma	2012-15	4.0L	63-9037	2	+ 9 hp	77-9037KP	2	+ 8 hp
Tacoma	2005-14	4.0L	57-9025	1	+ 9 hp	•	•	•
Tacoma	2005-11	4.0L	63-9025	2	+ 10 hp	77-9025KP	2	+ 10 hp
Tundra	2010-17	4.6L	63-9035	2	+ 14 hp	77-9035KP	2	+ 10 hp
Tundra	2014-17	5.7L	57-9036	1	+ 6 hp	77-9036KP	2	+ 7 hp
Tundra	2007-11	5.7L	63-9031-1	2	+ 13 hp	77-9031-1KP	2	+ 13 hp
Tundra	2007-09	4.7L	63-9032-1	2	+ 8 hp	77-9032-1KP	2	+ 9 hp

1) Street Legal in 50 States 2) Street Legal in most states, not legal for sale or use in California or other states with similar emission control regulations
3) w/Round Filter 4) w/Panel Filter 5) LB7 6) LLY 7) Exc. 2 Valve VIN W NOTE: Prefix 57 and 63 usually incorporate black molded high density polyethylene tubes. Prefix 69 and 77 incorporate aluminum tubes. †Estimated horsepower and torque gains based on specific or similar vehicle dynamometer tests. Results will vary. Visit knfilters.com for specifications regarding emissions standards and CARB regulations and additional testing and estimated horsepower information.

HIGH-FLOW AIR FILTERS™ FOR AUTOMOBILES

- Designed to increase horsepower and acceleration
- Washable and reusable
- 10-year/million mile limited warranty
for details, visit knfilters.com/warranty
- Drops into your factory air box in 5 minutes
- Up to 50,000 miles between cleanings
(under normal highway driving conditions)



Scosche 2015 GMC Denali Duramax



**HIGH-FLOW WASHABLE
COTTON MEDIA**



**DURABLE URETHANE OR
PLASTISOL FRAME**



**DROPS EASILY INTO YOUR
FACTORY AIR BOX**

HIGH-FLOW AIR AND OIL FILTERS - Visit knfilters.com for additional product listings

CHEVROLET	YEAR(S)	ENGINE (LITERS)	AIR FILTER	OIL FILTER	NOTE
Avalanche	2007-13	5.3L	33-2129	HP-1017	
Avalanche	2007-09	6.0L	33-2135	HP-1017	
Canyon	2015-16	2.5L/3.6L	33-5030	HP-1017	
Colorado	2008-12	2.9L	33-2408	HP-1007	
Colorado	2008-12	3.7L	33-2408	HP-2006	
Colorado	2009-12	5.3L	33-2408	HP-1017	
Silverado 1500	2014-15	4.3L	33-2129	HP-2011	
Silverado 1500	2014-15	5.3L	33-2129	HP-2011	
Silverado 1500	2014-15	6.2L	33-2135	HP-2011	

CHEVROLET	YEAR(S)	ENGINE (LITERS)	AIR FILTER	OIL FILTER	NOTE
Silverado 1500	2001-13	4.3L	33-2129	HP-1001	
Silverado 1500	2007-13	4.8/5.3L	33-2129	HP-1017	
Silverado 1500	2009-11	6.2L	33-2135	HP-1017	
Silverado 1500	2003-06	4.8/5.3L	33-2129	HP-1007	
Silverado 1500	1999-02	4.8/5.3L	33-2129	HP-2006	
Silverado 1500	1999-00	4.3L	33-2129	HP-2001	
Silverado 1500 Clsc	2007	4.3L	33-2129	HP-1001	
Silverado 1500 Clsc	2007	4.8/5.3L	33-2129	HP-1017	
Silverado 2500 HD/3500	2007-15	6.0L	33-2135	HP-1017	

1) w/Panel Air Filter 2) w/Round Air Filter 3) 3/4 thread Oil Filter 4) 22mm Thread Oil Filter 5) Spin On Oil Filter

WRENCH-OFF® OIL FILTERS FOR AUTOMOBILES

Rockstar Garage 2011 Twin Turbo Duramax



- Welded 1" filter nut eases removal
- High flow and high filtration
- Designed to be compatible with synthetic motor oils
- Heavy duty canister construction
- K&N® Limited Warranty
for details, visit knfilters.com/warranty



**PRE-DRILLED NUT
FOR EASY REMOVAL**



**DURABLE CANISTER
CONSTRUCTION**



**CARTRIDGE OIL FILTERS
ALSO AVAILABLE**

HIGH-FLOW AIR AND OIL FILTERS - Visit knfilters.com for additional product listings

CHEVROLET	YEAR(S)	ENGINE (LITERS)	AIR FILTER	OIL FILTER	NOTE
Silverado 2500 HD/3500	2011-15	6.6L DSL	33-2466	HP-3003	
Silverado 2500 HD/3500	2006-10	6.6L DSL	E-0781	HP-3003	
Silverado 2500 HD/3500	2001-06	8.1L	33-2135	HP-1011	
Silverado 2500 HD/3500	2003-06	6.0L	33-2135	HP-1007	
Silverado 2500 HD/3500	2005	6.6L DSL	33-2135	HP-3003	1
Silverado 2500 HD/3500	2005	6.6L DSL	E-0781	HP-3003	2
Silverado 2500 HD/3500	2001-04	6.6L DSL	33-2135	HP-3003	
Silverado 2500 HD/3500	2001-02	6.0L	33-2135	HP-2006	
Silv 2500 HD/3500 Clsc	2007	8.1L	33-2135	HP-1011	

CHEVROLET	YEAR(S)	ENGINE (LITERS)	AIR FILTER	OIL FILTER	NOTE
Silv 2500 HD/3500 Clsc	2007	6.0L	33-2135	HP-1017	
Silv 2500 HD/3500 Clsc	2007	6.6L DSL	E-0781	HP-3003	
Suburban 1500	2007-16	5.3L	33-2129	HP-1017	
Suburban 1500	2012-13	6.0L	•	HP-1017	
Suburban 1500	2003-06	5.3L	33-2129	HP-1007	
Tahoe	2007-15	5.3L	33-2129	HP-1017	
Tahoe	2007-09	4.8L	33-2129	HP-1017	
Tahoe	2003-06	4.8/5.3L	33-2129	HP-1007	

CONTINUED ON NEXT PAGE...

1) w/Panel Air Filter 2) w/Round Air Filter 3) 3/4 thread Oil Filter 4) 22mm Thread Oil Filter 5) Spin On Oil Filter

AMERICAN V-TWIN

STREET

OFF-ROAD

WATERCRAFT/SNOW

SPECIALTY/ACCESSORIES

HAULER/
HORSEPOWER

APPAREL/SIGNAGE

K&N® PRODUCT LISTINGS

HIGH-FLOW AIR AND OIL FILTERS FOR AUTOMOBILES

HIGH-FLOW AIR AND OIL FILTERS - Visit knfilters.com for additional product listings

CHEVROLET CONT.	YEAR(S)	ENGINE (LITERS)	AIR FILTER	OIL FILTER	NOTE
Tahoe	2000-02	4.8/5.3L	33-2129	HP-2006	
TrailBlazer	2002-09	4.2L	E-1009	HP-2006	
Traverse	2011-15	3.6L	33-2394	HP-2011	
Traverse	2009-10	3.6L	33-2394	HP-1017	
Dakota	2008-10	4.7L	33-2175	HP-2010	
Durango	2015	5.7L	•	HP-2010	
Durango	2011-14	3.6L	33-2457	•	
Durango	2011-14	5.7L	33-2457	HP-2010	
Ram 1500 PU	2008-10	4.7/5.7L	33-2247	HP-2010	
Ram 1500 PU	2002-08	3.7L	33-2247	HP-2009	
Ram 1500 PU	2002-07	4.7L	33-2247	HP-2004	
Ram 1500 PU	2003-07	5.7L	33-2247	HP-2004	
Ram 2500/3500 PU	2008-10	5.7L	33-2247	HP-2010	
Ram 2500/3500 PU	2010	6.7L DSL	E-0787	HP-4003	
Ram 2500/3500 PU	2003-09	5.9L DSL	E-0776	HP-4003	
Ram 2500/3500 PU	2007-09	6.7L DSL	E-0784	HP-4003	
Ram 2500/3500 PU	2003-07	5.7L	33-2247	HP-2004	
Ram 2500/3500 PU	1994-02	5.9L DSL	33-2056	HP-4003	
Ram 2500/3500 PU	1994-02	8.0L	33-2058	HP-2004	
Ram 2500/3500 PU	1994-02	5.9L	33-2084	HP-2004	

FORD

Excursion	2000-05	6.8L	E-0945	HP-2010	
Excursion	2003-05	6.0L DSL	E-0780	•	
Excursion	2000-03	7.3L DSL	33-2248	HP-6001	
Expedition	2015	3.5L	33-2385	HP-2011	
Expedition	2007-14	5.4L	33-2385	HP-2010	
Expedition	2005-06	5.4L	33-2287	HP-2010	
Expedition	1997-04	4.6/5.4L	E-0945	HP-2010	
Explorer	2011-15	3.5L	33-2395	HP-2011	
Explorer	2015	2.0L	•	HP-1002	
Explorer	2012-14	2.0L	33-2395	HP-1002	
Explorer	2006-10	4.6L	33-2353	HP-2010	
Explorer	2006-10	4.0L	33-2366	HP-2010	
F150	2011-15	3.5L	33-2385	HP-2011	
F150	2011-15	5.0L	33-2385	HP-2011	
F150	2015	2.7L	33-2385	•	
F150	2011-14	6.2L	33-2385	HP-2010	
F150	2011-14	3.7L	33-2385	HP-2011	
F150	2009-10	5.4L	33-2385	HP-2010	
F150	1997-08	4.2L	E-0945	HP-2009	
F150	2004-08	5.4L	33-2287	HP-2010	
F150	2004-08	4.6L	E-0945	HP-2009	3
F150	2004-08	4.6L	E-0945	HP-2010	4
F150	1997-03	4.6/5.4L	E-0945	HP-2010	
F150 Harley Davidson	2002-03	5.4L	33-2140-1	HP-2010	
F150 Harley Davidson	2000-01	5.4L	E-0945	HP-2010	
F150 Heritage	2004	4.6/5.4L	E-0945	HP-2010	
F150 SVT Raptor	2010-14	6.2L	33-2385	HP-2010	
F150 SVT Raptor	2010	5.4L	33-2385	HP-2010	
F250/F350 Super Duty	2011-15	6.2L	33-2385	HP-2010	

FORD CONT.	YEAR(S)	ENGINE (LITERS)	AIR FILTER	OIL FILTER	NOTE
F250/F350 Super Duty	2011-15	6.7L DSL	33-5010	HP-4005	
F250/F350 Super Duty	2008-10	5.4/6.8L	33-2385	HP-2010	
F250/F350 Super Duty	2008-10	6.4L DSL	E-0785	•	
F250/F350 Super Duty	2005-07	5.4L	33-2287	HP-2010	
F250/F350 Super Duty	2005-07	6.8L	33-2313	HP-2010	
F250/F350 Super Duty	2003-06	6.0L DSL	E-0780	•	
F250/F350 Super Duty	1999-04	5.4L	E-0945	HP-2010	
F250/F350 Super Duty	1999-04	6.8L	E-0945	HP-2010	
F250/F350 Super Duty	2000-03	7.3L DSL	33-2248	HP-6001	
Ranger	2012-15	2.5L	E-0662	•	
Ranger	2012-15	2.2L/3.2L DSLE	E-0662	•	

GMC

Canyon	2015-16	2.5L/3.6L	33-5030	HP-1017	
Canyon	2008-12	2.9L	33-2408	HP-1007	
Canyon	2008-12	3.7L	33-2408	HP-2006	
Canyon	2009-12	5.3L	33-2408	HP-1017	
Sierra	2015	5.3L	33-2129	HP-2011	
Sierra	2007	5.3L	33-2129	HP-1017	
Sierra 1500	2014-15	4.3L	33-2129	HP-2011	
Sierra 1500	2014-15	6.2L	33-2135	HP-2011	
Sierra 1500	2015	5.3L	33-2129	HP-2011	
Sierra 1500	2007-14	5.3L	33-2129	HP-1017	
Sierra 1500	2000-13	4.3L	33-2129	HP-1001	
Sierra 1500	2007-13	4.8L	33-2129	HP-1017	
Sierra 1500	2009-13	6.2L	33-2135	HP-1017	
Sierra 1500	2007-09	6.0L	33-2135	HP-1017	
Sierra 1500	2003-06	4.8/5.3L	33-2129	HP-1007	
Sierra 1500	2005-06	6.0L	33-2135	HP-1007	
Sierra 1500	1999-02	4.8/5.3L	33-2129	HP-2006	
Sierra 1500 Clsc	2007	4.3L	33-2129	HP-1001	
Sierra 1500 Clsc	2007	4.8/5.3L	33-2129	HP-1017	
Sierra 2500 HD/3500	2007-15	6.0L	33-2135	HP-1017	
Sierra 2500 HD/3500	2012-15	6.6L DSL	33-2466	HP-3003	
Sierra 2500 HD/3500	2011	6.6L DSL	33-2466	HP-3003	
Sierra 2500 HD/3500	2006-10	6.6L DSL	E-0781	HP-3003	
Sierra 2500 HD/3500	2001-06	8.1L	33-2135	HP-1011	
Sierra 2500 HD/3500	2003-06	6.0L	33-2135	HP-1007	
Sierra 2500 HD/3500	2005	6.6L DSL	33-2135	HP-3003	1
Sierra 2500 HD/3500	2005	6.6L DSL	E-0781	HP-3003	2
Sierra 2500 HD/3500	2001-04	6.6L DSL	33-2135	HP-3003	
Sierra 2500 HD/3500	2001-02	6.0L	33-2135	HP-2006	
Sier 2500 HD/3500 Clsc	2007	8.1L	33-2135	HP-1011	
Sier 2500 HD/3500 Clsc	2007	6.0L	33-2135	HP-1017	
Sier 2500 HD/3500 Clsc	2007	6.6L DSL	E-0781	HP-3003	
Terrain	2010-15	2.4L	33-2439	PS-7000	
Terrain	2013-15	3.6L	33-2439	HP-2011	
Terrain	2011-12	3.0L	33-2439	HP-2011	
Yukon	2007-15	5.3L	33-2129	HP-1017	
Yukon	2011	6.2L	33-2135	HP-1017	
Yukon	2007-09	4.8L	33-2129	HP-1017	

1) w/Panel Air Filter 2) w/Round Air Filter 3) 3/4 thread Oil Filter 4) 22mm Thread Oil Filter 5) Spin On Oil Filter

HIGH-FLOW AIR AND OIL FILTERS FOR AUTOMOBILES

HIGH-FLOW AIR AND OIL FILTERS - Visit knfilters.com for additional product listings

GMC CONT.	YEAR(S)	ENGINE (LITERS)	AIR FILTER	OIL FILTER	NOTE
Yukon	2003-06	4.8/5.3L	33-2129	HP-1007	
Yukon	2000-02	4.8/5.3L	33-2129	HP-2006	
Yukon XL	2015	5.3L	33-2129	HP-1017	
Yukon XL 1500	2007-14	5.3L	33-2129	HP-1017	
Yukon XL 1500	2013-14	6.2L	33-2135	HP-1017	
Yukon XL 1500	2009-11	6.2L	33-2135	HP-1017	
Yukon XL 1500	2007-09	6.0L	33-2135	HP-1017	
Yukon XL 1500	2003-06	5.3L	33-2129	HP-1007	
JEEP					
Cherokee	2014-15	3.2L	33-5009	•	
Cherokee	2014-15	2.4L	33-5009	HP-1017	
Grand Cherokee	2011-15	3.6L	33-2457	•	
Grand Cherokee	2011-15	5.7L	33-2457	HP-2010	
Grand Cherokee	2012-15	6.4L	33-2457	HP-2010	
Renegade	2014-16	1.6/2.0L	DSL33-5023	•	
Wrangler	2007-15	2.8L	DSL 33-5023	•	
Wrangler	2012-15	3.6L	33-2364	•	
Wrangler	2007-11	3.8L	33-2364	HP-1002	
Wrangler	1998-06	4.0L	33-2114	HP-2004	
Wrangler	2003-06	2.4L	33-2261	HP-1002	
Wrangler	1998-02	2.5L	33-2114	HP-2004	
NISSAN					
Armada	2015	5.6L	•	HP-1010	
Armada	2005-14	5.6L	33-2286	HP-1010	
Frontier	2005-15	4.0L	33-2286	HP-1010	
Frontier	2005-14	2.5L	33-2324	HP-1008	
Frontier	1998-04	2.4L	E-9233	HP-1010	
Frontier	1999-04	3.3L	33-2031-2	HP-1010	
Titan	2015	5.6L	33-2286	HP-1010	
Titan	2012-14	5.6L	33-2286	HP-1008	
Titan	2004-11	5.6L	33-2286	HP-1010	
Xterra	2015	4.0L	•	HP-1010	
Xterra	2005-14	4.0L	33-2286	HP-1010	
Xterra	2000-04	3.3L	33-2031-2	HP-1010	
Xterra	2000-04	2.4L	E-9233	HP-1010	
RAM					
1500	2013-15	3.6L	33-2247	•	
1500	2013-15	5.7L	33-2247	HP-1017	
1500	2014-15	3.0L	DSL 33-2247	•	
1500	2011-13	4.7L	33-2247	HP-2010	
1500	2011-12	5.7L	33-2247	HP-2010	
2500/3500	2013-15	5.7L	33-2247	HP-1017	
2500/3500	2013-15	6.7L	DSL 33-5005	HP-4003	
2500/3500	2015	6.4L	33-2247	•	
2500/3500	2014	6.4L	33-2247	HP-1017	

**MANY MORE AIR AND OIL FILTERS
AVAILABLE FOR CARS AND TRUCKS
AT KNFILTERS.COM**

RAM CONT.	YEAR(S)	ENGINE (LITERS)	AIR FILTER	OIL FILTER	NOTE
2500/3500	2011-12	5.7L	33-2247	HP-2010	
2500/3500	2011-12	6.7L	DSL E-0787	HP-4003	
TOYOTA					
4 Runner	2015	4.0L	33-2438	•	
4 Runner	2012-14	4.0L	33-2438	•	
4 Runner	2003-09	4.0L	33-2281	HP-1002	
4 Runner	2003-08	4.7L	33-2144	HP-1002	
FJ Cruiser	2010-14	4.0L	33-2438	•	
FJ Cruiser	2007-09	4.0L	33-2281	HP-1002	
Land Cruiser	2013-14	5.7L	33-2387	•	
Land Cruiser	2008-11	5.7L	33-2387	•	
Land Cruiser	1998-07	4.7L	33-2146	HP-1002	
Sequoia	2001-07	4.7L	33-2144	HP-1002	
Sequoia	2008-09	4.7L	33-2387	HP-1002	
Sequoia	2008-13	5.7L	33-2387	•	
Sequoia	2010-12	4.6L	33-2387	•	
Sequoia	2014-16	5.7L	33-5017	•	
Tacoma	2005-15	4.0L	33-2281	HP-1002	
Tacoma	2005-16	2.7L	33-2306	HP-1002	
Tacoma	1995-04	2.4/2.7L	33-2050-1	HP-1002	
Tacoma	1995-04	3.4L	33-2054	HP-1002	
Tundra	2014-17	4.6/5.7L	33-5017	•	
Tundra	2012-14	4.0L	33-2387	•	
Tundra	2007-13	5.7L	33-2387	•	
Tundra	2010-13	4.6L	33-2387	•	
Tundra	2011	4.0L	33-2387	HP-1002	5
Tundra	2005-10	4.0L	33-2281	HP-1002	
Tundra	2007-09	4.7L	33-2387	HP-1002	
Tundra	2000-06	4.7L	33-2144	HP-1002	
Tundra	2000-04	3.4L	33-2144	HP-1002	



1) w/Panel Air Filter 2) w/Round Air Filter 3) 3/4 thread Oil Filter 4) 22mm Thread Oil Filter 5) Spin On Oil Filter

HEAVY DUTY AIR FILTERS FOR DIESEL TRUCKS AND RVs

Our heavy duty air filters are constructed with extra strength and reinforcements to withstand the harsh conditions that can be found in commercial use. They are specially designed to withstand the extreme temperatures and pressures that can be present in large turbo diesel applications. They are also designed to avoid collapsing or losing their seal under the high levels of compression and air flow encountered in commercial environments.

DRYFLOW
AIR FILTER TECHNOLOGY



for details, visit knfilters.com/warranty

Hybrid Filtration Media

Our Hybrid air filtration media is a non-woven synthetic material designed to be used dry with no oil required. It is comprised of lofted non-woven synthetic fibers, giving the air filter high airflow/low-restriction while providing large dust holding capacities.

Easy To Clean & Reuse - Uses No Oil

These filters are incredibly easy to clean and nearly indestructible. After you apply our special degreaser, (1 gallon bottle #99-0638), you can use pressure washers, power sprayers, or water hose nozzles to clean the filter.



K&N® truck & trailer coming soon to an event near you



HEAVY DUTY AIR FILTER CROSS REFERENCE

K&N®	BALDWIN	CARQUEST	DONALDSON	FARR / RACOR	FLEETGUARD	FRAM	LUBER-FINER	NAPA	WIX
38-2000S*	PA4653	87818	•	400820014	•	•	•	2818	42818
38-2001S/R*	PA2721	88891	P537447	062891001	AH1104	CA7229	LAF1828	6891	46891
38-2002S/R*	PA2722	88893	P537448	062891002	AH1105	CA7230	LAF1848	6893	46893
38-2003R*	PA2723	88895	P537449	062891003	AH8505	CA7231	LAF1844	6895	46895
38-2006S*	PA3493	88748	P537454	114880003	AH1197	CA8130	LAF1934	6748	46748
38-2007S*	PA3556	88755	P537453	114500003	AH1193	CA6855	LAF2521	6755	46755
38-2008S*	PA2839	88623	P522874	•	AF25668	CA7113	LAF1839	6623	46623
38-2009R*	PA30073	83600	•	094973007	•	•	•	9660	49660
38-2011S*	RS3517	88744	P532966	•	AF25223	CA8193	LAF4498	6744	46744
38-2012S*	RS3518	88556	P527682	•	AF25139M	CA7140	LAF1849	6556	46556
38-2013S*	RS3548	88664	P533930	•	AF25355	CA8466	LAF3930	6664	46664
38-2014S*	PA3555	88759	P537452	114500002	AH1192	CA8129	LAF22026	6759	46759
38-2015R*	RS3539	88843	P534816	•	AF25247	CA8081	LAF4816	6843	46843
38-2016S*	RS4993	83708	P613333	•	AF25708M	CA11519	LAF5962	9708	49708
38-2017S*	PA2761	88506	R804759	•	AF4697	CA6696	LAF1947	6506	46506
38-2018S*	RS3750	87455	P549644	•	AF25598	CA9009	LAF5873	2455	42455
38-2019S*	RS3530	88745	P533235	•	AF25033	CA7466	LAF1953	6745	46745
38-2020S*	RS4859	88907	P614563	•	AF26667	CA9663	LAF2032	6907	46907
38-2021R*	RS3534	88863	P534925	•	AF25248	CA8231	LAF3302	6863	46863
38-2022S*	RS3516	88842	P534096	•	AF25219	CA7727	LAF2536	6842	46842
38-2023S*	RS4634	87808	P616691	•	AF26363	CA9869	LAF5114MXM	2808	42808
38-2024S*	RS3740	88772	P540388	•	AF25435	CA8598	LAF5722	6772	46772
38-2025S*	RS4642	83126	P606720	•	AF26163M	CA9901	LAF9201	9126	49126
38-2026S*	RS4636	88870	P606503	•	AF25707	CA9346	LAF9099	6870	46870
38-2027S*	RS4862	83088	P613336	•	AF26103	CA10305	LAF6663	9088	49088
38-2028S*	PA2456	87546	P181049	•	AF891	CA3273	LAF6453	2546	42546
38-2029S*	PA2705	88883	P153551	•	AF1968	CA3990	LAF3551	6883	46883
38-2030R*	PA2608	88868	P181186	•	AF996M	CA6918	LAF2608	6868	46868
38-2031S*	RS2863	88433	P527484	•	AF4878	CA7139	LAF1878	6433	46433
38-2032S*	PA2680	88882	P150695	•	AF1969	CA6512	LAF695	6882	46882
38-2033S*	PA3499	88904	P776157	•	AF25549	CA8003	LAF7472	6904	46904
38-2034R*	RS4572	87798	P544243	•	AF25955	CA9758	LAF6243	2798	42798
38-2035S*	RS5434	88932	P543614	•	AF27693	CA9856	LAF5633	6932	46932
38-2036R*	RS5287XP	93603XP	P614556	•	AF25144	•	LAF4556	500149	WA10149
38-2037R*	PA2317	87961	P181008	•	AF852	CA595	LAF6918	2961	42961
38-2038R*	PA2357	87661	P181009	•	AF865	CA596	LAF6880	2661	42661
38-2039R*	PA2493	87941	P181016	•	AF1616	CA2588	LAF8494	2941	42941
38-2040R*	PA2312	87966	P181007	•	AF853	CA1581	LAF7797	2966	42966
38-2042R*	PA2732	87610	P522293	•	AF4588M	CA3517A	LAF1770	2610	42610
38-2043R*	RS5288XP	93009	P614986	•	AF27948	•	LAF6986	500009	WA10009

*S = standard flow. R = Reverse flow. Some air filters are available in both variations. Cross references should be used for comparison of filters with similar dimensions. The user assumes all responsibility for verifying that filters are compatible with their vehicle before using these products. Damage may result if the user fails to ensure that the filter is compatible and seals properly before installing the product or operating the engine. Please call K&N's Customer Service Department at 1-877-AIR-FILTER for assistance when choosing the appropriate replacement air filter.

HEAVY DUTY WRENCH-OFF® OIL FILTERS FOR DIESEL TRUCKS AND RVs



K&N® heavy duty wrench-off® oil filters have been specially designed for the high compression levels and tighter tolerances of turbo diesel engines. Our synthetic micro-glass media provides lower restriction and incredible engine protection. Add to this our thicker canister and higher burst strength and you have one serious heavy duty oil filter.



WRENCH-OFF
PERFORMANCE OIL FILTERS



STURDY 1" NUT FOR EASY REMOVAL



SYNTHETIC MEDIA FOR HIGH DIRT CAPACITY AND FILTRATION EFFICIENCY



DICHROMATE PLATED BASE PLATE WITH DOUBLE-ROLLED SEAL

HEAVY DUTY WRENCH-OFF® OIL FILTER CROSS REFERENCE

K&N®	BALDWIN		CARQUEST		DONALDSON		FLEETGUARD		FRAM		LUBER-FINER		NAPA		WIX	
HP-8000	B495	B495-MPG B495-SS	85971	85971XD	P552100	ELF3998 LF9620	LF3620	LF3671	PH7405A	PH7405	LFP2160	LFP2160XL	1971	1971XD	51971	51971XD
HP-8001	B76	B76-MPG B76-SS B7600-SS	85791	85791XD 85791XE	P553191	P554004 ELF7483	LF667	LF3379 LF9667	PH8842	PH49A HPH49A	LFP3191	LFP3191SC LFP3191XL	1791	1791XD 1791XE	51791	51791XD 51791XE
HP-8002	B99	B99-MPG B99-SS	85792	85792XD 85792XE	P554005	P554105 ELF7405	LF691	LF691A LF3374 LF9691	PH3335	HPH3335 PH3426	LFP4005	LFP4005RN LFP4005XL	1792P	1792XD 1792XE	51792	51792XD 51792XE
HP-8003	BD103	BD103-SS	85748	85748XD	P553000	ELF7300	LF3000	LF3639 LF9009	PH6349A	HPH6349A HPH6349	LFP3000	LFP3000XL	1748	1748XD	51748	51748XD
HP-8006	BD7154		84745XD	84746XD	P559000	ELF7900	LF9031	LF9080	•	•	LFP9001		7745XD	7746XD	57745XD	57746XD
HP-8017	BT427		85602		P558616	ELF7345	LF3345		PH3900		LFP3900		1602		51602	
HP-8021	BT237		85459		P554407		LF699	LF787	PH977A		LFP2292		1459		51459	
HP-8025	BD7250		84744XD		P550656	P552025	LF9025		PH9971	PH9971A	LFP9025		7744XD		57744XD	
HP-8026	P7235		84311		P550528		LF16166		CH9549		LP2017		7311		57311	
HP-8027	P7188		84215		P550761		LF3914		CH9260		LP8741		7215		57215	
HP-8028	P7230		84213		P550769	ELF7690	LF16046		CH9558		LP5048		7213		57213	

Cross references should be used for comparison of filters with similar dimensions. The user assumes all responsibility for verifying that filters are compatible with their vehicle before using these products. Damage may result if the user fails to ensure that the filter is compatible and seals properly before installing the product or operating the engine. Please call K&N's Customer Service Department at 1-877-AIR-FILTER for assistance when choosing the appropriate replacement oil filter.



SIGNAGE / DISPLAYS

AUTHORIZED DEALER PROGRAM

LET KNFILTERS.COM WORK FOR YOU

Over 1 million unique visitors each month

- Check your dealer listing, get registered, and easily look up products at knfilters.com

THE BENEFITS DON'T STOP AT REFERRALS

- Online and phone referrals direct customers to your store
- Includes new product data and application updates
- Receive a free welcome kit and sales collateral
- Includes sales literature and catalogs, price list, POP materials, banners, window clings and decals

FREE K&N® WELCOME KIT

- Available for verified powersports dealers that currently sell K&N® products
- Includes a variety of powersports promotional display material and literature to educate your staff and customers on the benefits of K&N® products
- Kit includes K&N® powersports catalogs, sales brochure, audio training CD, mini-brochures, decals, banners and POP displays to help promote K&N® in-store sales

K&N® AUTHORIZED DEALER DISPLAY

- Proudly displays K&N® performance filters and cleaning supplies
- Centralizes and organizes your K&N® inventory for ease of ordering
- Increases education and traffic to the complete K&N® product line
- Easy to assemble, black powder coated metal construction
- Contact your K&N® representative today to qualify

K&N® PERFORMANCE FILTERS MAKE YOU MORE PROFIT AND YOUR JOB EASIER TO ACCOMPLISH

If your parts and service departments aren't stocking and servicing K&N® filters across the board and making conscious efforts to push them at each opportunity, you are missing out on valuable profits.



PART NUMBER
87-3039-10



PART NUMBER
87-3058

28w x 67h x 14d

K&N® Displays and Promotional Materials are Available to Authorized K&N® Dealers with Qualifying Stock of Both K&N® Air and Oil Filters.

MERCHANDISING / SIGNAGE

DISPLAYS AND POP

Teaching consumers about the benefits of K&N® products and the technology behind K&N® air filters is what influences consumers to upgrade to the best. All of our communication, advertising, displays, and catalogs are designed to communicate our straight forward and easy-to-understand product benefits.



PART NUMBER
87-11610



PART NUMBER
87-11611



PART NUMBER
87-1124-3



PART NUMBER
87-11614

MERCHANDISING / SIGNAGE DISPLAYS AND POP

Premium dealers use K&N® signage to increase brand recognition



PART NUMBER
89-11918



PART NUMBER
89-11493-17

PART NUMBER
89-11595



PART NUMBER
89-11824-09



PART NUMBER
89-11917



PART NUMBER
89-11820-1



PART NUMBER
89-11837-1

PART NUMBER
87-1118



MERCHANDISING TOOLS - Visit knfilters.com for complete listings

DISPLAYS/PROMOTIONAL

Powersports Dealer Display (28"W X 67"H X 14"D)	87-3055
Air Filter Display Sportbike (11"W X 10"H X 3"D)	87-11610
Air Filter Display Cruiser (11"W X 10"H X 3"D)	87-11611
Air Intake Display (25"W X 14.5"H X 9.5"D)	89-11909-10
Air Flow Demonstrator 110V (14"W X 10.5"H X 17.25"D)	87-1124-3
Oil Filter Dispenser (22"W X 26.75"H X 6"D)	87-11614

STORE SIGNAGE/MERCHANDISING

	PART NO.
Authorized Dealer, 2-Sided Window Decal (11"W X 6.375"H)	89-11595
Table Tent; Air Filters and Oil Filters (8.5"W X 3"H X 3.75"D)	87-1118
Shelf Wobbler; Air Filters (4"W X 8.75"H)	89-11824-09
Shelf Wobbler; Oil Filters (4"W X 8.75"H)	89-11917
Embossed Aluminum Sign (20"W X 9"H)	89-11837-1
Double-Sided Sign, K&N® High-Flow Technology (8"H X 5"W)	89-11820-1

PROMOTIONAL MATERIALS

2017 K&N® Wall Calendar (14"W x 10.5" H)	89-11853-17
2017 K&N® Shop Calendar (24"W X 18"H)	89-11493-17
K&N Nylon Banner (72"W X 42"H)	89-11839

SALES LITERATURE

	PART NO.
K&N Sales Card; Oil Filters	89-11918
Powersports Mini-Brochure	89-11548
Automotive Mini-Brochure	89-11803-06
2017 Powersports Catalog	89-11483-17
2017 Automotive Catalog	89-11482-17

DECALS

K&N® Logo Decal; AMA; Black (3"W X 1.3"H)	89-16191
K&N® Logo Decal; AMA; White (3"W X 1.3"H)	89-16190
K&N® Logo Decal; Black (4.5" X 1.375"H)	89-0020-05
K&N® Logo Decal; White (4.5" X 1.375"H)	89-0030-05
K&N® Logo Decal; White, Die-Cut (6"W X 2"H)	89-16180
K&N® Logo Decal; Black, Die-Cut (6"W X 2"H)	89-16181
K&N® Logo Decal; Black (9"W X 4"H)	89-16182-1
K&N® Logo Decal; Trailer; Black (30"W X 15"H)	89-16167-1

ACCESSORIES

K&N® Patch, White with Black Outline (4.25"W X 1.75"H)	89-0019
--	---------

AMERICAN V-TWIN

STREET

OFF-ROAD

WATERCRAFT/SNOW

SPECIALTY/ACCESSORIES

HAULER HORSEPOWER

APPAREL/
SIGNAGE

K&N® PRODUCT LISTINGS

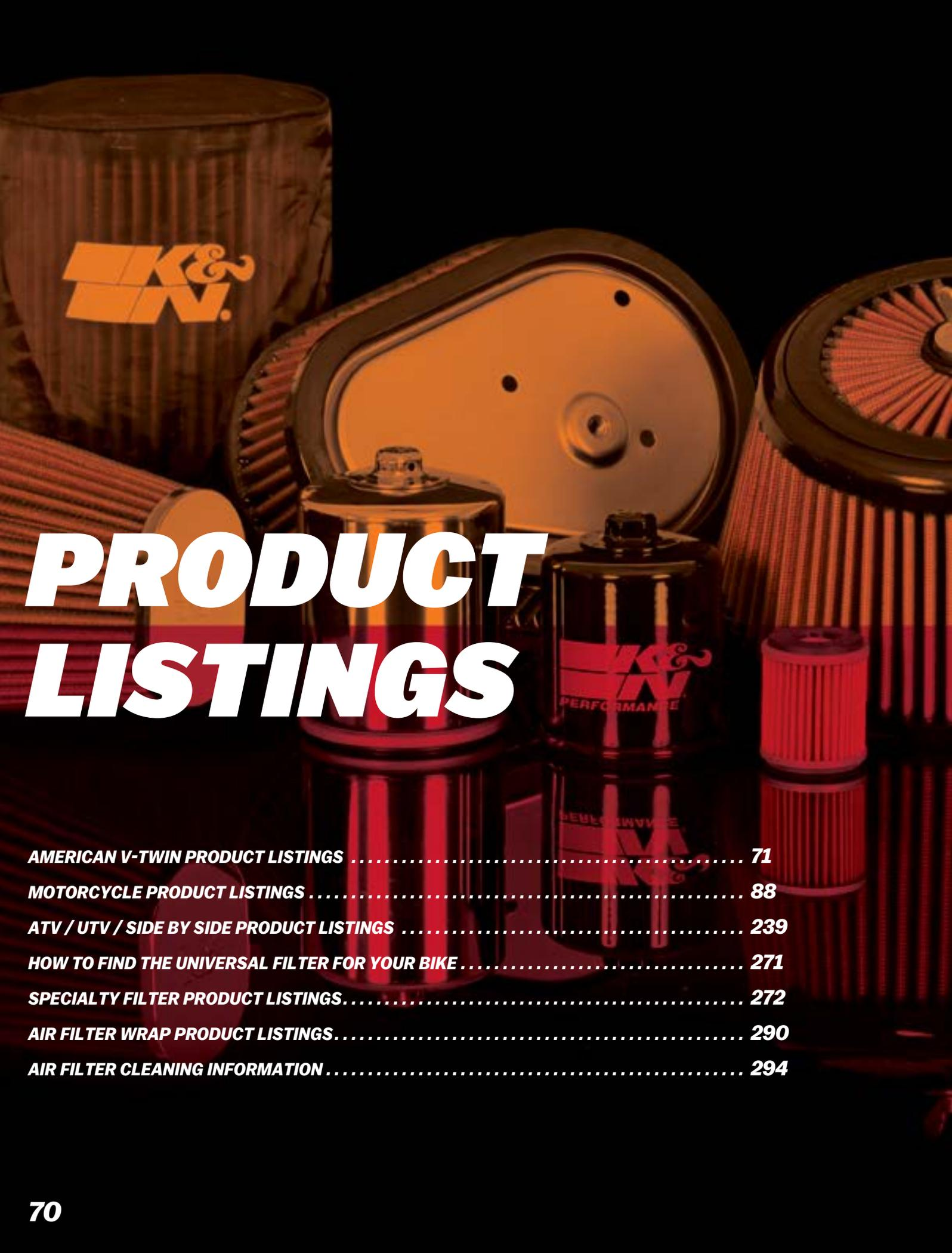

PRODUCT LISTINGS

AMERICAN V-TWIN PRODUCT LISTINGS	71
MOTORCYCLE PRODUCT LISTINGS	88
ATV / UTV / SIDE BY SIDE PRODUCT LISTINGS	239
HOW TO FIND THE UNIVERSAL FILTER FOR YOUR BIKE	271
SPECIALTY FILTER PRODUCT LISTINGS.....	272
AIR FILTER WRAP PRODUCT LISTINGS.....	290
AIR FILTER CLEANING INFORMATION	294



American V-Twin - Air & Oil Filters

Vehicle	Engine	Air Filter	Oil Filter
2010 BUELL			
1125CR	1125	BU-1108	KN-564
1125R	1125	BU-1108	KN-564
Blast	500	BU-5000	
Firebolt XB12R	1168	BU-9003	KN-177
Lightning City XB12SX	1200		KN-177
Lightning CityX XB9SX	900	BU-9003	KN-177
Lightning Long XB12SS	1200	BU-9003	KN-177
Lightning XB12SCG	1200	BU-9003	KN-177
Ulysses Police XB12XP	1200	BU-9003	KN-177
Ulysses XB12X	1200	BU-9003	KN-177
Ulysses XB12XT	1200	BU-9003	KN-177

Vehicle	Engine	Air Filter	Oil Filter
2009 BUELL			
1125CR	1125	BU-1108	KN-564
1125R	1125	BU-1108	KN-564
Blast	500	BU-5000	KN-177
Firebolt XB12R	1168	BU-9003	KN-177
Lightning CityX XB9SX	900	BU-9003	KN-177
Lightning Long XB12SS	1200	BU-9003	KN-177
Lightning XB12SCG	1200	BU-9003	KN-177
Ulysses Police XB12XP	1200	BU-9003	KN-177
Ulysses XB12X	1168	BU-9003	KN-177
Ulysses XB12XT	1168	BU-9003	KN-177

Vehicle	Engine	Air Filter	Oil Filter
2008 BUELL			
1125R	1125	BU-1108	
Blast	480	BU-5000	KN-177
Firebolt XB12R	1168	BU-9003	KN-177
Lightning CityX XB9SX	900		KN-177
Lightning Long XB12SS	1200	BU-9003	KN-177
Lightning XB9SX	900	BU-9003	KN-177
Lightning XB12S	1200	BU-9003	KN-177
Lightning XB12SCG	1200	BU-9003	KN-177
Lightning XB12STT	1200	BU-9003	KN-177
Ulysses XB12X	1168	BU-9003	KN-177
Ulysses XB12XT	1168	BU-9003	KN-177

Vehicle	Engine	Air Filter	Oil Filter
2007 BUELL			
Blast	480	BU-5000	KN-177
Firebolt XB9R	961	BU-9003	KN-177
Firebolt XB12R	1168	BU-9003	KN-177
Lightning CityX XB9SX	900	BU-9003	KN-177
Lightning Long XB12SS	1200	BU-9003	KN-177
Lightning XB12S	1200	BU-9003	KN-177
Lightning XB12SCG	1200	BU-9003	KN-177
Lightning XB12STT	1200	BU-9003	KN-177
Ulysses XB12X	1168	BU-9003	KN-177

Vehicle	Engine	Air Filter	Oil Filter
2006 BUELL			
Blast	480	BU-5000	KN-177
Firebolt XB9R	961	BU-9003	KN-177
Firebolt XB12R	1168	BU-9003	KN-177
Lightning CityX XB9SX	900	BU-9003	KN-177
Lightning Long XB12SS	1200	BU-9003	KN-177
Lightning XB12S	1200	BU-9003	KN-177
Lightning XB12SCG	1200	BU-9003	KN-177
Ulysses XB12X	1168	BU-9003	KN-177

Vehicle	Engine	Air Filter	Oil Filter
2005 BUELL			
Blast	480	BU-5000	KN-177
Firebolt XB9R	961	BU-9003	KN-177
Firebolt XB12R	1168	BU-9003	KN-177
Lightning CityX XB9SX	900	BU-9003	KN-177
Lightning XB12S	1200	BU-9003	KN-177
Lightning XB12SCG	1200	BU-9003	KN-177

Vehicle	Engine	Air Filter	Oil Filter
2004 BUELL			
Blast	480	BU-5000	KN-177
Firebolt XB9R	961	BU-9003	KN-177
Firebolt XB12R	1168	BU-9003	KN-177
Lightning XB9S	900	BU-9003	KN-177
Lightning XB12S	1200	BU-9003	KN-177

Vehicle	Engine	Air Filter	Oil Filter
2003 BUELL			
Blast	480	BU-5000	KN-177
Firebolt XB9R	961	BU-9003	KN-177
Lightning XB9S	900	BU-9003	KN-177

Vehicle	Engine	Air Filter	Oil Filter
2002 BUELL			
Blast	480	BU-5000	KN-177
Firebolt XB9R	1131	BU-9003	KN-177
M2 Cyclone	1168	BU-1297	KN-171C*
M2 Cyclone Low	1168	BU-1297	KN-171C*
S1 Lightning	1200	BU-1297	KN-177
S2 Thunderbolt	1200	BU-1297	KN-177
S2T Thunderbolt	1200	BU-1297	KN-177
S3 Thunderbolt	1168	BU-1297	KN-177
S3T Thunderbolt	1168	BU-1297	KN-177
X1 Lightning	1200	BU-1297	KN-171C*
X1W White Lightning	1200	BU-1297	KN-171C*

Vehicle	Engine	Air Filter	Oil Filter
2001 BUELL			
Blast	480	BU-5000	KN-177
M2 Cyclone	1168	BU-1297	KN-171C*
S1 Lightning	1200	BU-1297	KN-177
S2 Thunderbolt	1200	BU-1297	KN-177
S2T Thunderbolt	1200	BU-1297	KN-177
S3 Thunderbolt	1168	BU-1297	KN-177
S3T Thunderbolt	1168	BU-1297	KN-177
X1 Lightning	1200	BU-1297	KN-171C*

Vehicle	Engine	Air Filter	Oil Filter
2000 BUELL			
Blast	480	BU-5000	KN-177
M2 Cyclone	1168	BU-1297	KN-171C*
S1 Lightning	1200	BU-1297	KN-177
S2 Thunderbolt	1200	BU-1297	KN-177
S2T Thunderbolt	1200	BU-1297	KN-177
S3 Thunderbolt	1168	BU-1297	KN-177
S3T Thunderbolt	1168	BU-1297	KN-177
X1 Lightning	1200	BU-1297	KN-171C*

Vehicle	Engine	Air Filter	Oil Filter
1999 BUELL			
M2 Cyclone	1168	BU-1297	KN-171C*
S1 Lightning	1168	BU-1297	KN-171C*
S2 Thunderbolt	1200	BU-1297	KN-171C*
S2T Thunderbolt	1200	BU-1297	KN-171C*
S3 Thunderbolt	1168	BU-1297	KN-171C*
S3T Thunderbolt	1168	BU-1297	KN-171C*
X1 Lightning	1200	BU-1297	KN-171C*

Vehicle	Engine	Air Filter	Oil Filter
1998 BUELL			
M2 Cyclone	1168	BU-1297	KN-171C*
S1 Lightning	1168	BU-1297	KN-171C*
S1 White Lightning	1200	BU-1297	KN-171C*
S2 Thunderbolt	1200	BU-1297	KN-171C*
S2T Thunderbolt	1200		KN-171C*
S3 Thunderbolt	1168	BU-1297	KN-171C*
S3T Thunderbolt	1168	BU-1297	KN-171C*

Vehicle	Engine	Air Filter	Oil Filter
1997 BUELL			
M2 Cyclone	1168	BU-1297	KN-171C*
S1 Lightning	1168	BU-1297	KN-171C*
S2 Thunderbolt	1200		KN-171C*

♦ Intake Available. See Pages 10-15 ^ Use KN-170 for Black * Change C to B for Black Applications updated daily at knfilters.com ®

American V-Twin - Air & Oil Filters



Vehicle	Engine	Air Filter	Oil Filter
---------	--------	------------	------------

1997 BUELL

S2T Thunderbolt	1200		KN-171C*
S3 Thunderbolt	1168	BU-1297	KN-171C*
S3T Thunderbolt	1168	BU-1297	KN-171C*

1996 BUELL

S1 Lightning	1168	BU-1297	KN-171C*
S2 Thunderbolt	1168		KN-171C*
S2T Thunderbolt	1168		KN-171C*
S3 Thunderbolt	1168		KN-171C*
S3T Thunderbolt	1168		KN-171C*

1995 BUELL

S1 Lightning	1168		KN-171C*
S2 Thunderbolt	1168		KN-171C*
S2T Thunderbolt	1168		KN-171C*
S3 Thunderbolt	1200		KN-171C*
S3T Thunderbolt	1200		KN-171C*

1994 BUELL

S1 Lightning	1168		KN-171C*
S2 Thunderbolt	1168		KN-171C*
S2T Thunderbolt	1168		KN-171C*
S3 Thunderbolt	1200		KN-171C*
S3T Thunderbolt	1200		KN-171C*

2017 HARLEY DAVIDSON

FLHR Road King	107 CI	HD-1717	♦
FLHTCU Electra Glide Ultra Classic	107 CI	HD-1717	
FLHTCUTG Tri Glide Ultra	107 CI	HD-1717	♦
FLHTK Ultra Limited	107 CI	HD-1717	♦
FLHTKL Ultra Limited Low	107 CI	HD-1717	♦
FLHX Street Glide	107 CI	HD-1717	♦
FLHXS Street Glide Special	107 CI	HD-1717	♦
FLRT Freewheeler	107 CI	HD-1717	♦
FLS Softail Slim	103 CI	HD-1614	♦
FLSTC Heritage Softail Classic	103 CI	HD-1614	♦
FLSTF Fat Boy	103 CI	HD-1614	♦
FLSTFB Softail Fat Boy Lo	103 CI	HD-1614	
FLSTN Softail Deluxe	103 CI	HD-1614	♦
FLTRU Road Glide Ultra	107 CI	HD-1717	♦
FLTRX Road Glide	107 CI	HD-1717	♦
FLTRXS Road Glide Special	107 CI	HD-1717	♦
FXDB Dyna Street Bob	103 CI	HD-1611	♦
FXDF Fat Bob	103 CI	HD-0910	♦
FXDL Dyna Low Rider	103 CI	HD-0910	♦
FXDWG Dyna Wide Glide	103 CI	HD-0910	♦
FXSB Breakout	103 CI	HD-1614	♦
VRSCDX Night Rod Special	76 CI	HD-1102	
VRSCF V-Rod Muscle	76 CI	HD-1102	
XG500 Street	30 CI	HD-4915	
XG750 Street	46 CI	HD-4915	
XL883L SuperLow	54 CI	HD-1212	♦
XL883N Iron	54 CI	HD-1212	♦
XL1200C Sportster Custom	74 CI	HD-1212	
XL1200T SuperLow	74 CI	HD-1212	
XL1200X Forty-Eight	74 CI	HD-1212	
XL1200XC Sportster Roadster	74 CI	HD-1212	

2016 HARLEY DAVIDSON

FLD Switchback	103 CI	HD-0910	♦ KN-171C*
FLD Switchback - Non-US	103 CI	HD-9608	KN-171C*
FLHR Road King	103 CI	HD-1614	♦ KN-171C*
FLHSSE CVO Street Glide	110 CI		KN-171C*
FLHTCU Electra Glide Ultra Classic	103 CI	HD-1614	KN-171C*

Vehicle	Engine	Air Filter	Oil Filter
---------	--------	------------	------------

2016 HARLEY DAVIDSON

FLHTCUL Electra Glide Ultra Classic Low	103 CI	HD-1614	KN-171C*
FLHTCUTG Tri Glide Ultra	103 CI	HD-1614	KN-171C*
FLHTK Ultra Limited	103 CI	HD-1614	KN-171C*
FLHTKL Ultra Limited Low	103 CI	HD-1614	KN-171C*
FLHTKSE CVO Limited	110 CI	HD-0910	KN-171C*
FLHX Electra Glide Special	103 CI	HD-1614	
FLHX Street Glide	103 CI	HD-1614	KN-171C*
FLHXS Street Glide Special	103 CI	HD-1614	♦ KN-171C*
FLHXSE CVO Street Glide	110 CI	HD-0910	
FLRT Freewheeler	103 CI	HD-1614	♦ KN-171C*
FLS Softail Slim	103 CI	HD-1614	♦ KN-171C*
FLSS Softail Slim S	110 CI		KN-171C*
FLSTC Heritage Softail Classic	103 CI	HD-1614	♦ KN-171C*
FLSTF Fat Boy	103 CI	HD-1614	♦ KN-171C*
FLSTFB Softail Fat Boy Lo	103 CI	HD-1614	♦ KN-171C*
FLSTFBS Fat Boy S	110 CI		KN-171C*
FLSTN Softail Deluxe	103 CI	HD-1614	♦ KN-171C*
FLTRU Road Glide Ultra	103 CI	HD-1614	KN-171C*
FLTRUSE CVO Road Glide Ultra	110 CI	HD-0910	KN-171C*
FLTRX Road Glide	103 CI	HD-1614	♦ KN-171C*
FLTRXS Road Glide Special	103 CI	HD-1614	♦ KN-171C*
FXDB Dyna Street Bob	103 CI	HD-1611	♦ KN-171C*
FXDF Fat Bob	103 CI	HD-0910	♦ KN-171C*
FXDF Fat Bob - Non-US	103 CI	HD-9608	KN-171C*
FXDL Dyna Low Rider	103 CI	HD-0910	♦ KN-171C*
FXDL Dyna Low Rider - Non-US	103 CI	HD-9608	KN-171C*
FXDLS Low Rider S	110 CI		KN-171C*
FXDWG Dyna Wide Glide	103 CI	HD-0910	♦ KN-171C*
FXDWG Dyna Wide Glide - Non-US	103 CI	HD-9608	KN-171C*
FXSB Breakout	103 CI	HD-1614	♦ KN-171C*
VRSCDX Night Rod Special	76 CI	HD-1102	
VRSCF V-Rod Muscle	76 CI	HD-1102	
XG500 Street	30 CI	HD-4915	♦ KN-204
		HD-4915	♦ KN-204C
XG750 Street	46 CI	HD-4915	♦ KN-204
		HD-4915	♦ KN-204C
XL883L SuperLow	54 CI	HD-1212	♦ KN-171C*
XL883N Iron	54 CI	HD-1212	♦ KN-171C*
XL1200C Sportster Custom	74 CI	HD-1212	♦ KN-171C*
XL1200T SuperLow	74 CI	HD-1212	♦ KN-171C*
XL1200V Seventy-Two	74 CI	HD-1212	♦ KN-171C*
XL1200X Forty-Eight	74 CI	HD-1212	KN-171C*
XL1200XC Sportster Roadster	74 CI	HD-1212	

2015 HARLEY DAVIDSON

FLD Switchback	103 CI	HD-9608	♦ KN-171C*
FLHR Road King	103 CI	HD-1614	♦ KN-171C*
FLHTCU Electra Glide Ultra Classic	103 CI	HD-1614	♦ KN-171C*
FLHTCUL Electra Glide Ultra Classic Low	103 CI	HD-1614	♦ KN-171C*
FLHTCUTG Tri Glide Ultra	103 CI	HD-1614	♦ KN-171C*
FLHTK Ultra Limited	103 CI	HD-1614	♦ KN-171C*
FLHTKL Ultra Limited Low	103 CI	HD-1614	♦ KN-171C*
FLHTKSE CVO Limited	110 CI	HD-0910	KN-171C*
FLHX Street Glide	103 CI	HD-1614	♦ KN-171C*
FLHXS Street Glide Special	103 CI	HD-1614	♦ KN-171C*
FLHXSE CVO Street Glide	110 CI	HD-0910	KN-171C*
FLRT Freewheeler	103 CI	HD-1614	♦ KN-171C*
FLS Softail Slim	103 CI	HD-1611	♦ KN-171C*
FLSTC Heritage Softail Classic	103 CI	HD-1499	♦ KN-171C*
FLSTF Fat Boy	103 CI	HD-1499	♦ KN-171C*
FLSTFB Softail Fat Boy Lo	103 CI	HD-1499	♦ KN-171C*

♦ Intake Available. See Pages 10-15 ^ Use KN-170 for Black * Change C to B for Black Applications updated daily at knfilters.com ®



American V-Twin - Air & Oil Filters

Vehicle	Engine	Air Filter	Oil Filter
2015 HARLEY DAVIDSON			
FLSTN Softail Deluxe	103 CI	HD-1499 ♦	KN-171C*
FLSTNSE CVO Softail Deluxe	110 CI	HD-0910	KN-171C*
FLTRUSE CVO Road Glide Ultra	110 CI	HD-0910	KN-171C*
FLTRX Road Glide	103 CI	HD-1614 ♦	KN-171C*
FLTRXS Road Glide Special	103 CI	HD-1614 ♦	KN-171C*
FXDB Dyna Street Bob	103 CI	HD-1611 ♦	KN-171C*
FXDF Fat Bob	103 CI		KN-171C*
FXDL Dyna Low Rider	103 CI	HD-9608 ♦	KN-171C*
FXDWG Dyna Wide Glide	103 CI	HD-9608 ♦	KN-171C*
FXSB Breakout	103 CI	HD-1499 ♦	KN-171C*
VRSCDX Night Rod Special	76 CI	HD-1102	KN-174C*
VRSCF V-Rod Muscle	76 CI	HD-1102	KN-174C*
XG500 Street	30 CI	HD-4915 ♦	KN-204
		HD-4915 ♦	KN-204C
		HD-4915 ♦	KN-204C
XG750 Street	46 CI	HD-4915 ♦	KN-204
XL883L SuperLow	54 CI	HD-1212 ♦	KN-171C*
		HD-1212 ♦	KN-171C*
		HD-1212 ♦	KN-171C*
XL1200C Sportster Custom	74 CI	HD-1212	KN-171C*
XL1200T SuperLow	74 CI	HD-1212	KN-171C*
XL1200V Seventy-Two	74 CI	HD-1212	KN-171C*
XL1200X Forty-Eight	74 CI	HD-1212	KN-171C*

Vehicle	Engine	Air Filter	Oil Filter
2014 HARLEY DAVIDSON			
FLD Switchback	103 CI	HD-9608 ♦	KN-171C*
FLHR Road King	103 CI	HD-1614 ♦	KN-171C*
FLHRSE6 CVO Road King	110 CI		KN-171C*
FLHTCU Electra Glide Ultra Classic	103 CI	HD-1614 ♦	KN-171C*
FLHTCUTG Tri Glide Ultra	103 CI	HD-1614 ♦	KN-171C*
FLHTK Electra Glide Ultra Limited	103 CI	HD-1614 ♦	KN-171C*
FLHTKSE CVO Limited	110 CI	HD-0910	KN-171C*
FLHX Street Glide	103 CI	HD-1614 ♦	KN-171C*
FLHXS Street Glide Special	103 CI	HD-1614 ♦	KN-171C*
FLS Softail Slim	103 CI	HD-1611 ♦	KN-171C*
FLSTC Heritage Softail Classic	103 CI	HD-1499 ♦	KN-171C*
FLSTF Fat Boy	103 CI	HD-1499 ♦	KN-171C*
FLSTFB Softail Fat Boy Lo	103 CI	HD-1499 ♦	KN-171C*
FLSTN Softail Deluxe	103 CI	HD-1499 ♦	KN-171C*
FLSTNSE CVO Softail Deluxe	110 CI	HD-0910	KN-171C*
FXDB Dyna Street Bob	103 CI	HD-1611 ♦	KN-171C*
FXDC Dyna Super Glide Custom	103 CI	HD-9608 ♦	KN-171C*
FXDF Fat Bob	103 CI	HD-9608 ♦	KN-171C*
FXDL Dyna Low Rider	103 CI	HD-9608 ♦	KN-171C*
FXDWG Dyna Wide Glide	103 CI	HD-9608 ♦	KN-171C*
FXSB Breakout	103 CI	HD-1499 ♦	KN-171C*
FXSBSE CVO Breakout	103 CI		KN-171C*
VRSCDX Night Rod Special	76 CI	HD-1102	
VRSCF V-Rod Muscle	76 CI	HD-1102	
XG500 Street	30 CI		KN-204
			KN-204C
			KN-204C
XG750 Street	46 CI		KN-204
XL883L SuperLow	54 CI	HD-1212 ♦	KN-170C^
		HD-1212 ♦	KN-170C^
		HD-1212 ♦	KN-170C^
XL1200C Sportster Custom	74 CI	HD-1212 ♦	KN-170C^
XL1200T SuperLow	74 CI	HD-1212	
XL1200V Seventy-Two	74 CI	HD-1212 ♦	KN-170C^
XL1200X Forty-Eight	74 CI	HD-1212 ♦	KN-170C^

Vehicle	Engine	Air Filter	Oil Filter
2013 HARLEY DAVIDSON			
FLD Switchback	103 CI	HD-9608 ♦	KN-171C*
FLHR Road King	103 CI	HD-1508 ♦	KN-171C*
FLHRC Road King Classic	103 CI	HD-1508 ♦	KN-171C*
FLHRSE5 CVO Road King	110 CI	HD-0910	KN-171C*

Vehicle	Engine	Air Filter	Oil Filter
2013 HARLEY DAVIDSON			
FLHTC Electra Glide Classic	103 CI	HD-1508 ♦	KN-171C*
FLHTCU Ultra Classic Electra Glide	103 CI	HD-1508 ♦	KN-171C*
FLHTCUSE8 CVO Ultra Classic	110 CI	HD-0910	KN-171C*
Electra Glide F/I			
FLHTCUTG Tri Glide Ultra Classic	103 CI	HD-1508 ♦	KN-171C*
FLHTK Electra Glide Ultra Limited	103 CI	HD-1508 ♦	KN-171C*
FLHX Street Glide	103 CI	HD-1508 ♦	KN-171C*
FLS Softail Slim	103 CI	HD-1611 ♦	KN-171C*
FLSTC Heritage Softail Classic	103 CI	HD-1499 ♦	KN-171C*
FLSTF Fat Boy	103 CI	HD-1499 ♦	KN-171C*
FLSTFB Softail Fat Boy Lo	103 CI	HD-1499 ♦	KN-171C*
FLSTN Softail Deluxe	103 CI	HD-1499 ♦	KN-171C*
FLTRU Road Glide Ultra	103 CI	HD-1508 ♦	KN-171C*
FLTRX Road Glide Custom	103 CI	HD-1508 ♦	KN-171C*
FLTRXSE CVO Road Glide Custom	96 CI		KN-171C*
FXDB Dyna Street Bob	96 CI	HD-9608 ♦	KN-171C*
FXDC Dyna Super Glide Custom	96 CI	HD-9608 ♦	KN-171C*
FXDC Super Glide Custom	96 CI	HD-9608 ♦	KN-171C*
FXDF Fat Bob	103 CI	HD-9608 ♦	KN-171C*
FXDWG Dyna Wide Glide	103 CI	HD-9608 ♦	KN-171C*
FXS Blackline	103 CI	HD-1611 ♦	KN-171C*
FXSBSE CVO Breakout	110 CI		KN-171C*
VRSCDX Night Rod Special	76 CI	HD-1102	
VRSCF V-Rod Muscle	76 CI	HD-1102	
XL883L SuperLow	54 CI	HD-8834 ♦	KN-170C^
XL883N Iron	54 CI	HD-8834 ♦	KN-170C^
XL1200C Sportster Custom	74 CI	HD-8834 ♦	KN-170C^
XL1200V Seventy-Two	74 CI	HD-1212 ♦	KN-170C^
XL1200X Forty-Eight	74 CI	HD-8834 ♦	KN-170C^

Vehicle	Engine	Air Filter	Oil Filter
2012 HARLEY DAVIDSON			
FLD Switchback	103 CI	HD-9608 ♦	KN-171C*
FLHP Road King Police	103 CI	HD-1508 ♦	
FLHR Road King	103 CI	HD-1508 ♦	KN-171C*
FLHRC Road King Classic	103 CI	HD-1508 ♦	KN-171C*
FLHTC Electra Glide Classic	103 CI	HD-1508 ♦	KN-171C*
FLHTCU Electra Glide Ultra Classic	103 CI	HD-1508 ♦	KN-171C*
FLHTCUSE7 CVO Ultra Classic	110 CI	HD-0910	KN-171C*
Electra Glide			
FLHTCUTG Tri Glide Ultra Classic	103 CI	HD-1508 ♦	KN-171C*
FLHTK Electra Glide Ultra Limited	103 CI	HD-1508 ♦	KN-171C*
FLHTP Electra Glide Police	103 CI	HD-1508 ♦	
FLHX Street Glide	103 CI	HD-1508 ♦	KN-171C*
FLHXSE3 CVO Street Glide	110 CI	HD-0910	KN-171C*
FLS Softail Slim	103 CI	HD-1611 ♦	KN-171C*
FLSTC Heritage Softail Classic	103 CI	HD-1499 ♦	KN-171C*
FLSTF Fat Boy	103 CI	HD-1499 ♦	KN-171C*
FLSTFB Softail Fat Boy Lo	103 CI	HD-1499 ♦	KN-171C*
FLSTN Softail Deluxe	103 CI	HD-1499 ♦	KN-171C*
FLSTSE CVO Softail Convertible	110 CI	HD-0910	KN-171C*
FLTRU Road Glide Ultra	103 CI	HD-1508 ♦	KN-171C*
FLTRXSE CVO Road Glide Custom	96 CI	HD-1508 ♦	KN-171C*
FXDB Dyna Street Bob	96 CI	HD-9608 ♦	KN-171C*
FXDC Dyna Super Glide Custom	96 CI	HD-9608 ♦	KN-171C*
FXDF Fat Bob	103 CI	HD-9608 ♦	KN-171C*
FXDWG Dyna Wide Glide	103 CI	HD-9608 ♦	KN-171C*
FXS Blackline	103 CI	HD-1611 ♦	KN-171C*
VRSCDX 10th Anniversary Edition	76 CI	HD-1102	
VRSCDX Night Rod Special	76 CI	HD-1102	
VRSCF V-Rod Muscle	76 CI	HD-1102	
XL883L SuperLow	54 CI	HD-8834 ♦	KN-170C^
XL883N Iron	54 CI	HD-8834 ♦	KN-170C^

♦ Intake Available. See Pages 10-15 ^ Use KN-170 for Black * Change C to B for Black Applications updated daily at knfilters.com ®

Partial Listing: Complete Listing of Vehicles and Parts at KNFILTERS.COM or call 1-800-858-3333

American V-Twin - Air & Oil Filters



Vehicle	Engine	Air Filter	Oil Filter
2012 HARLEY DAVIDSON			
XL883R Sportster Roadster	54 CI	HD-8834	KN-170C^
XL1200C Sportster Custom	74 CI	HD-8834 ♦	KN-170C^
XL1200N Sportster Nightster	74 CI	HD-8834 ♦	KN-170C^
XL1200V Seventy-Two	74 CI	HD-1212 ♦	
XL1200X Forty-Eight	74 CI	HD-8834 ♦	KN-170C^
XR1200X Sportster	74 CI	HD-1208	KN-170C^

2011 HARLEY DAVIDSON			
FLHP Road King Police	103 CI	HD-1508 ♦	
FLHR Road King	96 CI	HD-1508 ♦	KN-171C*
FLHRC Road King Classic	103 CI	HD-1508 ♦	KN-171C*
FLHTC Electra Glide Classic	96 CI	HD-1508 ♦	KN-171C*
FLHTCU Ultra Classic Electra Glide	96 CI	HD-1508 ♦	KN-171C*
FLHTCUSE6 CVO Ultra Classic Electra Glide	110 CI	HD-0910	KN-171C*
FLHTCUTG Tri Glide Ultra Classic	103 CI	HD-1508 ♦	KN-171C*
FLHTK Electra Glide Ultra Limited	103 CI	HD-1508 ♦	KN-171C*
FLHTP Electra Glide Police	103 CI	HD-1508 ♦	
FLHX Street Glide	96 CI	HD-1508 ♦	KN-171C*
FLHXSE2 CVO Street Glide	110 CI	HD-0910	KN-171C*
FLHXXX Street Glide Trike	103 CI	HD-1508 ♦	KN-171C*
FLSTC Heritage Softail Classic	96 CI	HD-1499 ♦	KN-171C*
FLSTF Fat Boy	96 CI	HD-1499 ♦	KN-171C*
FLSTFB Softail Fat Boy Lo	96 CI	HD-1499 ♦	KN-171C*
FLSTN Softail Deluxe	96 CI	HD-1499 ♦	KN-171C*
FLSTSB Softail Cross Bones	96 CI	HD-1611 ♦	KN-171C*
FLSTSE CVO Softail Convertible	110 CI	HD-0910	KN-171C*
FLTRU Road Glide Ultra	103 CI	HD-1508 ♦	KN-171C*
FLTRUSE CVO Road Glide Ultra	110 CI	HD-0910	KN-171C*
FLTRX Road Glide Custom	96 CI	HD-1508 ♦	KN-171C*
FXCWC Rocker C	96 CI	HD-1499 ♦	KN-171C*
FXDB Dyna Street Bob	96 CI	HD-9608 ♦	KN-171C*
FXDC Dyna Super Glide Custom	96 CI	HD-9608 ♦	KN-171C*
FXDF Fat Bob	96 CI	HD-9608 ♦	KN-171C*
FXDWG Dyna Wide Glide	96 CI	HD-9608 ♦	KN-171C*
FXS Blackline	103 CI	HD-1611 ♦	KN-171C*
VRSCDX Night Rod Special	76 CI	HD-1102	
VRSCF V-Rod Muscle	76 CI	HD-1102	
XL883L SuperLow	54 CI	HD-8834 ♦	KN-170C^
XL883N Iron	54 CI	HD-8834 ♦	KN-170C^
XL1200C Sportster Custom	74 CI	HD-8834 ♦	KN-170C^
XL1200L Sportster Low	74 CI	HD-8834 ♦	KN-170C^
XL1200N Sportster Nightster	74 CI	HD-8834 ♦	KN-170C^
XL1200X Forty-Eight	74 CI	HD-8834 ♦	KN-170C^
XR1200X Sportster	74 CI	HD-1208	KN-170C^

2010 HARLEY DAVIDSON			
FLHP Road King Police	103 CI	HD-1508 ♦	
FLHR Road King	96 CI	HD-1508 ♦	KN-171C*
FLHRC Road King Classic	96 CI	HD-1508 ♦	KN-171C*
FLHT Electra Glide Standard	96 CI	HD-1508 ♦	
FLHTC Electra Glide Classic	96 CI	HD-1508 ♦	KN-171C*
FLHTCU Ultra Classic Electra Glide	96 CI	HD-1508 ♦	KN-171C*
FLHTCUSE5 CVO Ultra Classic Electra Glide	110 CI	HD-1508	KN-171C*
FLHTCUTG Tri Glide Ultra Classic	103 CI	HD-1508 ♦	KN-171C*
FLHTK Electra Glide Ultra Limited	103 CI	HD-1508 ♦	KN-171C*
FLHTP Electra Glide Police	103 CI	HD-1508 ♦	
FLHX Street Glide	96 CI	HD-1508 ♦	KN-171C*
FLHXSE CVO Street Glide	110 CI	HD-0910	KN-171C*
FLHXXX Street Glide Trike	103 CI	HD-1508 ♦	KN-171C*
FLSTC Heritage Softail Classic	96 CI	HD-1499 ♦	KN-171C*
FLSTF Fat Boy	96 CI	HD-1499 ♦	KN-171C*
FLSTFB Softail Fat Boy Lo	96 CI	HD-1499 ♦	KN-171C*

Vehicle	Engine	Air Filter	Oil Filter
2010 HARLEY DAVIDSON			
FLSTN Softail Deluxe	96 CI	HD-1499 ♦	KN-171C*
FLSTSB Softail Cross Bones	96 CI	HD-1611 ♦	KN-171C*
FLSTSE CVO Softail Convertible	110 CI	HD-0910	KN-171C*
FLTR Road Glide	96 CI	HD-1508 ♦	KN-171C*
FLTRX Road Glide Custom	96 CI	HD-1508 ♦	KN-171C*
FXCWC Rocker C	96 CI	HD-1499 ♦	KN-171C*
FXD Dyna Super Glide	96 CI	HD-9608 ♦	
FXDB Dyna Street Bob	96 CI	HD-9608 ♦	KN-171C*
FXDC Dyna Super Glide Custom	96 CI	HD-9608 ♦	KN-171C*
FXDF Fat Bob	96 CI	HD-9608 ♦	KN-171C*
FXDFSE2 CVO Dyna Fat Bob	96 CI		KN-171C*
FXDL Dyna Low Rider - Japan	96 CI	HD-9608	
FXDWG Dyna Wide Glide	96 CI	HD-9608 ♦	KN-171C*
FXSTC Softail Custom	96 CI	HD-1499 ♦	KN-171C*
VRSCAW V-Rod	69 CI	HD-1102	
VRSCDX Night Rod Special	76 CI	HD-1102	KN-174C*
VRSCF V-Rod Muscle	76 CI	HD-1102	KN-174C*
XL883C Sportster Custom	54 CI	HD-8834 ♦	KN-170C^
XL883L Sportster Low	54 CI	HD-8834 ♦	KN-170C^
XL883N Iron	54 CI	HD-8834 ♦	KN-170C^
XL1200C Sportster Custom	74 CI	HD-8834 ♦	KN-170C^
XL1200L Sportster Low	74 CI	HD-8834 ♦	KN-170C^
XL1200N Sportster Nightster	74 CI	HD-8834 ♦	KN-170C^
XL1200X Forty-Eight	74 CI	HD-8834 ♦	KN-170C^
XR1200X Sportster	74 CI	HD-1208	KN-170C^

2009 HARLEY DAVIDSON			
FLHP Road King Police	103 CI	HD-1508 ♦	KN-171C*
FLHR Road King	96 CI	HD-1508 ♦	KN-171C*
FLHRC Road King Classic	96 CI	HD-1508 ♦	KN-171C*
FLHT Electra Glide Standard	96 CI	HD-1508 ♦	KN-171C*
FLHTC Electra Glide Classic	96 CI	HD-1508 ♦	KN-171C*
FLHTCU Ultra Classic Electra Glide	96 CI	HD-1508 ♦	KN-171C*
FLHTCUSE4 CVO Ultra Classic Electra Glide	110 CI	HD-1508	KN-171C*
FLHTCUTG Tri Glide Ultra Classic	103 CI	HD-1508 ♦	KN-171C*
FLHTP Electra Glide Police	103 CI	HD-1508 ♦	KN-171C*
FLHX Street Glide	96 CI	HD-1508 ♦	KN-171C*
FLSTC Heritage Softail Classic	96 CI	HD-1499 ♦	KN-171C*
FLSTF Fat Boy	96 CI	HD-1499 ♦	KN-171C*
FLSTN Softail Deluxe	96 CI	HD-1499 ♦	KN-171C*
FLSTSB Softail Cross Bones	96 CI		KN-171C*
FLSTSB Softail Cross Bones - Non-US	96 CI	HD-1499 ♦	KN-171C*
FLSTSB Softail Cross Bones - US	96 CI	HD-1611 ♦	KN-171C*
FLTR Road Glide	96 CI	HD-1508 ♦	KN-171C*
FLTRSE3 CVO Road Glide	110 CI	HD-0910	KN-171C*
FXCW Rocker	96 CI	HD-1499 ♦	KN-171C*
FXCWC Rocker C	96 CI	HD-1499 ♦	KN-171C*
FXD Dyna Super Glide	96 CI	HD-9608 ♦	KN-171C*
FXDB Dyna Street Bob	96 CI	HD-9608 ♦	KN-171C*
FXDC Dyna Super Glide Custom	96 CI	HD-9608 ♦	KN-171C*
FXDF Fat Bob	96 CI	HD-9608 ♦	KN-171C*
FXDFSE CVO Fat Bob	110 CI		KN-171C*
FXDFSE CVO Fat Bob - Non-US	110 CI	HD-1499	KN-171C*
FXDL Dyna Low Rider	96 CI	HD-9608 ♦	KN-171C*
FXSTB Night Train	96 CI	HD-1499 ♦	KN-171C*
FXSTC Softail Custom	96 CI	HD-1499 ♦	KN-171C*
FXSTSE3 CVO Softail Springer	110 CI	HD-1499	KN-171C*
VRSCAW V-Rod	69 CI	HD-1102	KN-174C*
VRSCDX Night Rod Special	76 CI	HD-1102	KN-174C*
VRSCF V-Rod Muscle	76 CI	HD-1102	KN-174C*
XL883C Sportster Custom	54 CI	HD-8834 ♦	KN-170C^

♦ Intake Available. See Pages 10-15 ^ Use KN-170 for Black * Change C to B for Black Applications updated daily at knfilters.com ®



American V-Twin - Air & Oil Filters

Vehicle	Engine	Air Filter	Oil Filter
2009 HARLEY DAVIDSON			
XL883L Sportster Low	54 CI	HD-8834 ♦	KN-170C^
XL883N Iron	54 CI	HD-8834 ♦	KN-170C^
XL1200C Sportster Custom	74 CI	HD-8834 ♦	KN-170C^
XL1200L Sportster Low	74 CI	HD-8834 ♦	KN-170C^
XL1200N Sportster Nightster	74 CI	HD-8834 ♦	KN-170C^
XR1200	74 CI	HD-1208	KN-170C^

Vehicle	Engine	Air Filter	Oil Filter
2008 HARLEY DAVIDSON			
FLHR Road King	96 CI	HD-1508 ♦	KN-171C*
FLHRC Road King Classic	96 CI	HD-1508 ♦	KN-171C*
FLHRSE4 Screamin Eagle Road King	110 CI	HD-1508 ♦	KN-171C*
FLHT Electra Glide Standard	96 CI	HD-1508 ♦	KN-171C*
FLHTC Electra Glide Classic	96 CI	HD-1508 ♦	KN-171C*
FLHTCU Ultra Classic Electra Glide	96 CI	HD-1508 ♦	KN-171C*
FLHTCUSE3 Screamin Eagle Ultra Classic Electra Gl	110 CI	HD-1508	KN-171C*
FLHX Street Glide	96 CI	HD-1508 ♦	KN-171C*
FLSTC Heritage Softail Classic	96 CI	HD-1499 ♦	KN-171C*
FLSTF Fat Boy	96 CI	HD-1499 ♦	KN-171C*
FLSTN Softail Deluxe	96 CI	HD-1499 ♦	KN-171C*
FLSTSB Softail Cross Bones	96 CI		KN-171C*
FLSTSB Softail Cross Bones - Non-US	96 CI	HD-1499 ♦	KN-171C*
FLSTSB Softail Cross Bones - US	96 CI	HD-1611 ♦	KN-171C*
FLTR Road Glide	96 CI	HD-1508 ♦	KN-171C*
FXCW Rocker	96 CI	HD-1499 ♦	KN-171C*
FXCWC Rocker C	96 CI	HD-1499 ♦	KN-171C*
FXD Dyna Super Glide	96 CI	HD-9608 ♦	KN-171C*
FXDB Dyna Street Bob	96 CI	HD-9608 ♦	KN-171C*
FXDC Super Glide Custom	96 CI	HD-9608 ♦	KN-171C*
FXDF Fat Bob	96 CI	HD-9608 ♦	KN-171C*
FXDL Dyna Low Rider	96 CI	HD-9608 ♦	KN-171C*
FXDSE2 Screamin Eagle Dyna	110 CI		KN-171C*
FXDSE2 Screamin Eagle Dyna - US	110 CI	HD-0800	KN-171C*
FXDWG Dyna Wide Glide	96 CI	HD-9608 ♦	KN-171C*
FXSTB Night Train	96 CI	HD-1499 ♦	KN-171C*
FXSTC Softail Custom	96 CI	HD-1499 ♦	KN-171C*
FXSTSSE2 Screamin Eagle Softail Springer	110 CI		KN-171C*
VRSCAW V-Rod	69 CI	HD-1102	KN-174C*
VRSCD Night Rod	76 CI	HD-1102	KN-174C*
VRSCDX Night Rod Special	76 CI	HD-1102	KN-174C*
XL883 Sportster	54 CI	HD-8834 ♦	KN-170C^
XL883C Sportster Custom	54 CI	HD-8834 ♦	KN-170C^
XL883L Sportster Low	54 CI	HD-8834 ♦	KN-170C^
XL883R Sportster	54 CI	HD-8834 ♦	KN-170C^
XL1200C Sportster Custom	74 CI	HD-8834 ♦	KN-170C^
XL1200L Sportster Low	74 CI	HD-8834 ♦	KN-170C^
XL1200N Sportster Nightster	74 CI	HD-8834 ♦	KN-170C^
XL1200R Sportster Roadster	74 CI	HD-8834 ♦	KN-170C^
XR1200	74 CI	HD-1208	KN-170C^

Vehicle	Engine	Air Filter	Oil Filter
2007 HARLEY DAVIDSON			
FLHR Road King	96 CI	HD-1499 ♦	KN-171C*
FLHRC Road King Classic	96 CI	HD-1499 ♦	KN-171C*
FLHRS Road King Custom	96 CI	HD-1499 ♦	KN-171C*
FLHRSE3 Screamin Eagle Road King	110 CI		KN-171C*
FLHRSE3 Screamin Eagle Road King - OEM 2944299A/B/C/D	110 CI	HD-0800	KN-171C*
FLHT Electra Glide Standard	96 CI	HD-1499 ♦	KN-171C*
FLHTC Electra Glide Classic	96 CI	HD-1499 ♦	KN-171C*
FLHTCI Electra Glide Classic F/I	88 CI	HD-1499	KN-171C*
FLHTCU Ultra Classic Electra Glide	96 CI	HD-1499 ♦	KN-171C*

Vehicle	Engine	Air Filter	Oil Filter
2007 HARLEY DAVIDSON			
FLHTCUSE2 Screamin Eagle Ultra Classic Electra Gli	110 CI		KN-171C*
FLHTCUSE2 Screamin Eagle Ultra Classic Electra Gli - OEM 2944299A/B/C/D	110 CI	HD-0800	KN-171C*
FLHTP Electra Glide Police	103 CI	HD-1499	
FLHX Street Glide	96 CI	HD-1499 ♦	KN-171C*
FLSTC Heritage Softail Classic	96 CI	HD-1499 ♦	KN-171C*
FLSTF Fat Boy	96 CI	HD-1499 ♦	KN-171C*
FLSTN Softail Deluxe	96 CI	HD-1499 ♦	KN-171C*
FLSTSC Softail Springer Classic	96 CI	HD-1499 ♦	KN-171C*
FLTR Road Glide	96 CI	HD-1499 ♦	KN-171C*
FXD Dyna Super Glide	96 CI	HD-1499 ♦	KN-171C*
FXDB Dyna Street Bob	96 CI	HD-1499 ♦	KN-171C*
FXDC Super Glide Custom	96 CI	HD-1499 ♦	KN-171C*
FXDL Dyna Low Rider	96 CI	HD-1499 ♦	KN-171C*
FXDSE Screamin Eagle Dyna	110 CI		KN-171C*
FXDSE Screamin Eagle Dyna - OEM 2944299A/B/C/D	110 CI	HD-0800	KN-171C*
FXDWG Dyna Wide Glide	96 CI	HD-1499 ♦	KN-171C*
FXST Softail Standard	96 CI	HD-1499 ♦	KN-171C*
FXSTB Night Train	96 CI	HD-1499 ♦	KN-171C*
FXSTC Softail Custom	96 CI	HD-1499 ♦	KN-171C*
FXSTD Softail Deuce	96 CI	HD-1499 ♦	KN-171C*
FXSTSSE Screamin Eagle Softail Springer	110 CI		KN-171C*
FXSTSSE Screamin Eagle Softail Springer - OEM 2944299A/B/C/D	110 CI	HD-0800	KN-171C*
VRSCAW V-Rod	69 CI	HD-1102	KN-174C*
VRSCD Night Rod	69 CI	HD-1102	KN-174C*
VRSCDX Night Rod Special	69 CI	HD-1102	KN-174C*
VRSCR Street Rod	69 CI	HD-1102	KN-174C*
VRSCX	69 CI		KN-174C*
VRSCX V-Rod	76 CI	HD-1102	KN-174C*
XL50 50th Anniversary Sportster	74 CI	HD-8834 ♦	KN-170C^
XL883 Sportster	54 CI	HD-8834 ♦	KN-170C^
XL883C Sportster Custom	54 CI	HD-8834	KN-170C^
XL883L Sportster Low	54 CI	HD-8834	KN-170C^
XL883R Sportster	54 CI	HD-8834 ♦	KN-170C^
XL1200C Sportster Custom	74 CI	HD-8834 ♦	KN-170C^
XL1200L Sportster Low	74 CI	HD-8834 ♦	KN-170C^
XL1200N Sportster Nightster	74 CI	HD-8834 ♦	KN-170C^
XL1200R Sportster Roadster	74 CI	HD-8834 ♦	KN-170C^

Vehicle	Engine	Air Filter	Oil Filter
2006 HARLEY DAVIDSON			
FLHR Road King	88 CI	HD-1499	KN-171C*
FLHRCI Road King Classic F/I	88 CI	HD-1499 ♦	KN-171C*
FLHRI Road King F/I	88 CI	HD-1499 ♦	KN-171C*
FLHRS Road King Custom	88 CI	HD-1499	KN-171C*
FLHRSI Road King Custom F/I	88 CI	HD-1499 ♦	KN-171C*
FLHT Electra Glide Standard	88 CI	HD-1499	KN-171C*
FLHTCI Electra Glide Classic F/I	88 CI	HD-1499 ♦	KN-171C*
FLHTCUI Electra Glide Ultra Classic F/I	88 CI	HD-1499 ♦	KN-171C*
FLHTCUSE Screamin Eagle Ultra Classic Electra Glid	103 CI	HD-1499	
FLHTI Electra Glide Standard F/I	88 CI	HD-1499 ♦	KN-171C*
FLHX Street Glide	88 CI	HD-1499	KN-171C*
FLHXI Street Glide F/I	88 CI	HD-1499 ♦	KN-171C*
FLST Heritage Softail	88 CI	HD-1499	KN-171C*
FLSTC Heritage Softail Classic	88 CI	HD-1499	KN-171C*
FLSTCI Heritage Softail Classic F/I	88 CI	HD-1499 ♦	KN-171C*
FLSTF Fat Boy	88 CI	HD-1499	KN-171C*
FLSTF Fat Boy	96 CI		KN-171C*

♦ Intake Available. See Pages 10-15 ^ Use KN-170 for Black * Change C to B for Black Applications updated daily at knfilters.com ®

Partial Listing: Complete Listing of Vehicles and Parts at KNFILTERS.COM or call 1-800-858-3333

American V-Twin - Air & Oil Filters



Vehicle	Engine	Air Filter	Oil Filter	Vehicle	Engine	Air Filter	Oil Filter
2006 HARLEY DAVIDSON				2005 HARLEY DAVIDSON			
FLSTFI Fat Boy F/I	88 CI	HD-1499 ♦	KN-171C*	FLSTFSE Screamin Eagle Fat Boy	103 CI	HD-0800	KN-171C*
FLSTI Heritage Softail F/I	88 CI	HD-1499 ♦	KN-171C*	FLSTN Softail Deluxe	88 CI	HD-1499	KN-171C*
FLSTN Softail Deluxe	88 CI	HD-1499	KN-171C*	FLSTNI Softail Deluxe F/I	88 CI	HD-1499 ♦	KN-171C*
FLSTNI Softail Deluxe F/I	88 CI	HD-1499 ♦	KN-171C*	FLSTSC Softail Springer Classic	88 CI	HD-1499	KN-171C*
FLSTSC Softail Springer Classic	88 CI	HD-1499	KN-171C*	FLSTSCI Softail Springer Classic F/I	88 CI	HD-1499 ♦	KN-171C*
FLSTSCI Softail Springer Classic F/I	88 CI	HD-1499 ♦	KN-171C*	FLTR Road Glide	88 CI		KN-171C*
FLTR Road Glide	88 CI		KN-171C*	FLTRI Road Glide F/I	88 CI	HD-1499 ♦	KN-171C*
FLTRI Road Glide F/I	88 CI	HD-1499 ♦	KN-171C*	FXD Dyna Super Glide	88 CI	HD-1499	
FXDBI Street Bob F/I	88 CI	HD-1499 ♦	KN-171C*	FXDCI Dyna Super Glide Custom F/I	88 CI	HD-1499 ♦	KN-171C*
FXDCI Dyna Super Glide Custom F/I	88 CI	HD-1499 ♦	KN-171C*	FXDI Dyna Super Glide F/I	88 CI	HD-1499 ♦	KN-171C*
FXDI Dyna Super Glide F/I	88 CI	HD-1499 ♦	KN-171C*	FXDL Dyna Low Rider	88 CI	HD-1499	KN-171C*
FXDI35 35th Anniv. Super Glide F/I	88 CI	HD-1499 ♦	KN-171C*	FXDLI Dyna Low Rider F/I	88 CI	HD-1499 ♦	KN-171C*
FXDL Dyna Low Rider	88 CI	HD-1499	KN-171C*	FXDWG Dyna Wide Glide	88 CI	HD-1499	KN-171C*
FXDLI Dyna Low Rider F/I	88 CI	HD-1499 ♦	KN-171C*	FXDWGI Dyna Wide Glide F/I	88 CI	HD-1499 ♦	KN-171C*
FXDWG Dyna Wide Glide	88 CI	HD-1499	KN-171C*	FXDXI Dyna Super Glide Sport F/I	88 CI	HD-1499 ♦	KN-171C*
FXDWGI Dyna Wide Glide F/I	88 CI	HD-1499 ♦	KN-171C*	FXST Softail Standard	88 CI	HD-1499	KN-171C*
FXST Softail Standard	88 CI	HD-1499	KN-171C*	FXSTB Night Train	88 CI	HD-1499	KN-171C*
FXSTB Night Train	88 CI	HD-1499	KN-171C*	FXSTBI Night Train F/I	88 CI	HD-1499 ♦	KN-171C*
FXSTBI Night Train F/I	88 CI	HD-1499 ♦	KN-171C*	FXSTD Softail Deuce	88 CI	HD-1499	KN-171C*
FXSTD Softail Deuce	88 CI	HD-1499	KN-171C*	FXSTDI Softail Deuce F/I	88 CI	HD-1499 ♦	KN-171C*
FXSTDI Softail Deuce F/I	88 CI	HD-1499 ♦	KN-171C*	FXSTI Softail Standard F/I	88 CI	HD-1499 ♦	KN-171C*
FXSTI Softail Standard F/I	88 CI	HD-1499 ♦	KN-171C*	FXSTS Springer Softail	88 CI	HD-1499	KN-171C*
FXSTS Springer Softail	88 CI	HD-1499	KN-171C*	FXSTSI Springer Softail F/I	88 CI	HD-1499 ♦	KN-171C*
FXSTSI Springer Softail F/I	88 CI	HD-1499 ♦	KN-171C*	VRSCA V-Rod	69 CI	HD-1102	KN-174C*
VRSCA V-Rod	69 CI	HD-1102	KN-174C*	VRSCB V-Rod	69 CI	HD-1102	KN-174C*
VRSCD Night Rod	69 CI	HD-1102	KN-174C*	VRSCSE Screamin Eagle V-Rod	76 CI	HD-1102	KN-174C*
VRSCR Street Rod	69 CI	HD-1102	KN-174C*	XL883 Sportster	54 CI	HD-8834	KN-170C^
VRSCSE2 Screamin Eagle V-Rod	76 CI	HD-1102	KN-174C*	XL883C Sportster Custom	54 CI	HD-8834	KN-170C^
XL883 Sportster	54 CI	HD-8834	KN-170C^	XL883L Sportster Low	54 CI	HD-8834	KN-170C^
XL883C Sportster Custom	54 CI	HD-8834	KN-170C^	XL883R Sportster	54 CI	HD-8834	KN-170C^
XL883L Sportster Low	54 CI	HD-8834	KN-170C^	XL1200C Sportster Custom	74 CI	HD-8834	KN-170C^
XL883R Sportster	54 CI	HD-8834	KN-170C^	XL1200L Sportster Low	74 CI	HD-8834	KN-170C^
XL1200C Sportster Custom	74 CI	HD-8834	KN-170C^	XL1200R Sportster Roadster	74 CI	HD-8834	KN-170C^
XL1200L Sportster Low	74 CI	HD-8834	KN-170C^	XLH883 Sportster	54 CI		KN-170C^
XL1200R Sportster Roadster	74 CI	HD-8834	KN-170C^	XLH883 Sportster Custom	54 CI		KN-170C^
XLH883 Sportster	54 CI		KN-170C^	XLH883L Sportster Low	54 CI		KN-170C^
XLH883 Sportster Custom	54 CI	HD-8834	KN-170C^	XLH883R Sportster R	54 CI		KN-170C^
XLH883L Sportster Low	54 CI		KN-170C^				
XLH883R Sportster R	54 CI		KN-170C^	2004 HARLEY DAVIDSON			
2005 HARLEY DAVIDSON				FLHR Road King	88 CI	HD-1499	KN-171C*
FLHR Road King	88 CI	HD-1499	KN-171C*	FLHRCI Road King Classic F/I	88 CI	HD-1499 ♦	KN-171C*
FLHRCI Road King Classic F/I	88 CI	HD-1499 ♦	KN-171C*	FLHRI Road King F/I	88 CI	HD-1499 ♦	KN-171C*
FLHRI Road King F/I	88 CI	HD-1499 ♦	KN-171C*	FLHRS Road King Custom	88 CI	HD-1499	KN-171C*
FLHRS Road King Custom	88 CI	HD-1499	KN-171C*	FLHRSI Road King Custom F/I	88 CI	HD-1499 ♦	KN-171C*
FLHRSI Road King Custom F/I	88 CI	HD-1499 ♦	KN-171C*	FLHT Electra Glide Standard	88 CI	HD-1499	KN-171C*
FLHT Electra Glide Standard	88 CI	HD-1499	KN-171C*	FLHTC Electra Glide Classic	88 CI	HD-1499	KN-171C*
FLHTC Electra Glide Classic	88 CI	HD-1499	KN-171C*	FLHTCI Electra Glide Classic F/I	88 CI	HD-1499 ♦	KN-171C*
FLHTCI Electra Glide Classic F/I	88 CI	HD-1499 ♦	KN-171C*	FLHTCSE Screamin Eagle Electra Glide	103 CI		KN-171C*
FLHTCSE2 Screamin Eagle Electra Glide 2	103 CI		KN-171C*	FLHTCUI Electra Glide Ultra Classic F/I	88 CI	HD-1499 ♦	KN-171C*
FLHTCSE2 Screamin Eagle Electra Glide 2 - OEM 2944299A/B/C/D	103 CI	HD-0800	KN-171C*	FLHTI Electra Glide Standard F/I	88 CI	HD-1499 ♦	KN-171C*
FLHTCSE2 Screamin Eagle Electra Glide 2 - OEM 2946199	103 CI	HD-1499	KN-171C*	FLSTC Heritage Softail Classic	88 CI	HD-1499	KN-171C*
FLHTCUI Electra Glide Ultra Classic F/I	88 CI	HD-1499 ♦	KN-171C*	FLSTCI Heritage Softail Classic F/I	88 CI	HD-1499 ♦	KN-171C*
FLHTI Electra Glide Standard F/I	88 CI	HD-1499 ♦	KN-171C*	FLSTF Fat Boy	88 CI	HD-1499	KN-171C*
FLSTC Heritage Softail Classic	88 CI	HD-1499	KN-171C*	FLSTF Fat Boy	96 CI		KN-171C*
FLSTCI Heritage Softail Classic F/I	88 CI	HD-1499 ♦	KN-171C*	FLSTFI Fat Boy F/I	88 CI	HD-1499 ♦	KN-171C*
FLSTF Fat Boy	88 CI	HD-1499	KN-171C*	FLTR Road Glide	88 CI		KN-171C*
FLSTF Fat Boy	96 CI		KN-171C*	FLTRI Road Glide F/I	88 CI	HD-1499 ♦	KN-171C*
FLSTFI Fat Boy F/I	88 CI	HD-1499 ♦	KN-171C*	FXD Dyna Super Glide	88 CI	HD-1499	
FLSTFI Fat Boy F/I 15th Anniv.	95 CI	HD-0800	KN-171C*	FXDI Dyna Super Glide F/I	88 CI	HD-1499 ♦	KN-171C*
				FXDL Dyna Low Rider	88 CI	HD-1499	KN-171C*
				FXDLI Dyna Low Rider F/I	88 CI	HD-1499 ♦	KN-171C*
				FXDWG Dyna Wide Glide	88 CI	HD-1499	KN-171C*
				FXDWGI Dyna Wide Glide F/I	88 CI	HD-1499 ♦	KN-171C*

♦ Intake Available. See Pages 10-15 ^ Use KN-170 for Black * Change C to B for Black Applications updated daily at knfilters.com ®



American V-Twin - Air & Oil Filters

Vehicle	Engine	Air Filter	Oil Filter
2004 HARLEY DAVIDSON			
FXDX Dyna Super Glide Sport	88 CI	HD-1499	KN-171C*
FXDXI Dyna Super Glide Sport F/I	88 CI	HD-1499 ♦	KN-171C*
FXST Softail Standard	88 CI	HD-1499	KN-171C*
FXSTB Night Train	88 CI	HD-1499	KN-171C*
FXSTBI Night Train F/I	88 CI	HD-1499 ♦	KN-171C*
FXSTD Softail Deuce	88 CI	HD-1499	KN-171C*
FXSTDI Softail Deuce F/I	88 CI	HD-1499 ♦	KN-171C*
FXSTDSE2 Screamin Eagle Softail Deuce 2	95 CI		KN-171C*
FXSTI Softail Standard F/I	88 CI	HD-1499 ♦	KN-171C*
FXSTS Springer Softail	88 CI	HD-1499	KN-171C*
FXSTSI Springer Softail F/I	88 CI	HD-1499 ♦	KN-171C*
VRSCA V-Rod	69 CI	HD-1102	KN-174C*
VRSCB V-Rod	69 CI	HD-1102	KN-174C*
XL883 Sportster	54 CI	HD-8834	KN-170C^
XL883C Sportster Custom	54 CI	HD-8834	KN-170C^
XL883L Sportster Low	54 CI		KN-170C^
XL883R Sportster	54 CI		KN-170C^
XL1200C Sportster Custom	74 CI	HD-8834	KN-170C^
XL1200R Sportster Roadster	74 CI	HD-8834	KN-170C^
XLH883 Sportster	54 CI		KN-170C^
XLH883 Sportster Custom	54 CI		KN-170C^

Vehicle	Engine	Air Filter	Oil Filter
2003 HARLEY DAVIDSON			
FLHR Road King	88 CI	HD-1499	KN-171C*
FLHRCI Road King Classic F/I	88 CI	HD-1499 ♦	KN-171C*
FLHRI Road King F/I	88 CI	HD-1499 ♦	KN-171C*
FLHT Electra Glide Standard	88 CI	HD-1499	KN-171C*
FLHTC Electra Glide Classic	88 CI	HD-1499	KN-171C*
FLHTCI Electra Glide Classic F/I	88 CI	HD-1499 ♦	KN-171C*
FLHTCSE Screamin Eagle Electra Glide	103 CI		KN-171C*
FLHTCUI Electra Glide Ultra Classic F/I	88 CI	HD-1499 ♦	KN-171C*
FLHTI Electra Glide Standard F/I	88 CI	HD-1499 ♦	KN-171C*
FLHTSEI Screamin Eagle Road King F/I	103 CI		KN-171C*
FLSTC Heritage Softail Classic	88 CI	HD-1499	KN-171C*
FLSTCI Heritage Softail Classic F/I	88 CI	HD-1499 ♦	KN-171C*
FLSTF Fat Boy	88 CI	HD-1499	KN-171C*
FLSTF Fat Boy	96 CI		KN-171C*
FLSTFI Fat Boy F/I	88 CI	HD-1499 ♦	KN-171C*
FLSTS Heritage Springer	88 CI	HD-1499	KN-171C*
FLSTSI Heritage Springer F/I	88 CI	HD-1499 ♦	KN-171C*
FLTR Road Glide	88 CI		KN-171C*
FLTRI Road Glide F/I	88 CI	HD-1499 ♦	KN-171C*
FXD Dyna Super Glide	88 CI	HD-1499	KN-171C*
FXDL Dyna Low Rider	88 CI	HD-1499	KN-171C*
FXDWG Dyna Wide Glide	88 CI	HD-1499	KN-171C*
FXDX Dyna Super Glide Sport	88 CI	HD-1499	KN-171C*
FXDXT Dyna Super Glide T-Sport	88 CI	HD-1499	KN-171C*
FXST Softail Standard	88 CI	HD-1499	KN-171C*
FXSTB Night Train	88 CI	HD-1499	KN-171C*
FXSTBI Night Train F/I	88 CI	HD-1499 ♦	KN-171C*
FXSTD Softail Deuce	88 CI	HD-1499	KN-171C*
FXSTDI Softail Deuce F/I	88 CI	HD-1499 ♦	KN-171C*
FXSTDSE Screamin Eagle Softail Deuce	95 CI		KN-171C*
FXSTI Softail Standard F/I	88 CI	HD-1499 ♦	KN-171C*
FXSTS Springer Softail	88 CI	HD-1499	KN-171C*
FXSTSI Springer Softail F/I	88 CI	HD-1499 ♦	KN-171C*
VRSCA V-Rod	69 CI	HD-1102	KN-174C*
XL53C Sportster Custom	54 CI		KN-170C^
XL883C Sportster Custom	54 CI	HD-1388	KN-170C^

Vehicle	Engine	Air Filter	Oil Filter
2003 HARLEY DAVIDSON			
XL883R Sportster	54 CI	HD-1388	KN-170C^
XL1200C Sportster Custom	74 CI	HD-1388	KN-170C^
XL1200S Sportster Sport	74 CI	HD-1388	KN-170C^
XLH883 Sportster	54 CI	HD-1388	KN-170C^
XLH883 Sportster Custom	54 CI	HD-1388	KN-170C^
XLH883 Sportster Hugger	54 CI	HD-1388	KN-170C^
XLH1200 Sportster	73 CI	HD-1388	KN-170C^

Vehicle	Engine	Air Filter	Oil Filter
2002 HARLEY DAVIDSON			
FLHR Road King	88 CI	HD-1499	KN-171C*
FLHRCI Road King Classic F/I	88 CI	HD-1499 ♦	KN-171C*
FLHRI Road King F/I	88 CI	HD-1499	KN-171C*
FLHT Electra Glide Standard	88 CI	HD-1499	KN-171C*
FLHTC Electra Glide Classic	88 CI	HD-1499	KN-171C*
FLHTCI Electra Glide Classic F/I	88 CI	HD-1499 ♦	KN-171C*
FLHTCUI Electra Glide Ultra Classic F/I	88 CI	HD-1499 ♦	KN-171C*
FLSTC Heritage Softail Classic	88 CI	HD-1499	KN-171C*
FLSTCI Heritage Softail Classic F/I	88 CI	HD-1499 ♦	KN-171C*
FLSTF Fat Boy	88 CI	HD-1499	KN-171C*
FLSTFI Fat Boy F/I	88 CI	HD-1499 ♦	KN-171C*
FLSTS Heritage Springer	88 CI	HD-1499	KN-171C*
FLSTSI Heritage Springer F/I	88 CI	HD-1499 ♦	KN-171C*
FLTR Road Glide	88 CI	HD-1499	KN-171C*
FLTRI Road Glide F/I	88 CI	HD-1499 ♦	KN-171C*
FXD Dyna Super Glide	88 CI	HD-1499	KN-171C*
FXDL Dyna Low Rider	88 CI	HD-1499	KN-171C*
FXDWG Dyna Wide Glide	88 CI	HD-1499	KN-171C*
FXDX Dyna Super Glide Sport	88 CI	HD-1499	KN-171C*
FXDXT Dyna Super Glide T-Sport	88 CI	HD-1499	KN-171C*
FXST Softail Standard	88 CI	HD-1499	KN-171C*
FXSTB Night Train	88 CI	HD-1499	KN-171C*
FXSTBI Night Train F/I	88 CI	HD-1499 ♦	KN-171C*
FXSTD Softail Deuce	88 CI	HD-1499	KN-171C*
FXSTDI Softail Deuce F/I	88 CI	HD-1499 ♦	KN-171C*
FXSTI Softail Standard F/I	88 CI	HD-1499 ♦	KN-171C*
FXSTS Springer Softail	88 CI	HD-1499	KN-171C*
FXSTSI Springer Softail F/I	88 CI	HD-1499 ♦	KN-171C*
VRSCA V-Rod	69 CI	HD-1102	KN-174C*
XL53C Sportster Custom	54 CI		KN-170C^
XL883C Sportster Custom	54 CI	HD-1388	KN-170C^
XL883R Sportster	54 CI	HD-1388	KN-170C^
XL1200C Sportster Custom	74 CI	HD-1388	KN-170C^
XL1200S Sportster Sport	74 CI	HD-1388	KN-170C^
XLH883 Sportster	54 CI	HD-1388	KN-170C^
XLH883 Sportster Custom	54 CI	HD-1388	KN-170C^
XLH883 Sportster Hugger	54 CI	HD-1388	KN-170C^
XLH1200 Sportster	74 CI	HD-1388	KN-170C^

Vehicle	Engine	Air Filter	Oil Filter
2001 HARLEY DAVIDSON			
FLHR Road King	88 CI	HD-1499	KN-171C*
FLHRCI Road King Classic F/I	88 CI	HD-8899	KN-171C*
FLHRI Electra Glide Road King F/I	88 CI	HD-8899	KN-171C*
FLHRI Road King F/I	88 CI	HD-8899	KN-171C*
FLHT Electra Glide	82 CI		KN-171C*
FLHT Electra Glide Standard	88 CI	HD-1499	KN-171C*
FLHTC Electra Glide Classic	88 CI	HD-1499	KN-171C*
FLHTCI Electra Glide Classic F/I	88 CI	HD-8899	KN-171C*
FLHTCUI Electra Glide Ultra Classic F/I	88 CI	HD-8899	KN-171C*
FLSTC Heritage Softail Classic	88 CI	HD-1499	KN-171C*
FLSTCI Heritage Softail Classic F/I	88 CI	HD-8899	KN-171C*
FLSTF Fat Boy	88 CI	HD-1499	KN-171C*
FLSTFI Fat Boy F/I	88 CI	HD-1499 ♦	KN-171C*

♦ Intake Available. See Pages 10-15 ^ Use KN-170 for Black * Change C to B for Black Applications updated daily at knfilters.com ®

American V-Twin - Air & Oil Filters



Vehicle	Engine	Air Filter	Oil Filter	Vehicle	Engine	Air Filter	Oil Filter
2001 HARLEY DAVIDSON				1999 HARLEY DAVIDSON			
FLSTS Heritage Springer	88 CI	HD-1499	KN-171C*	FLHR Road King	88 CI	HD-1499	KN-171C*
FLSTSI Heritage Springer F/I	88 CI	HD-1499 ♦	KN-171C*	FLHRCI Road King Classic F/I	88 CI	HD-8899	KN-171C*
FLTR Road Glide	88 CI	HD-1499	KN-171C*	FLHT Electra Glide	82 CI		KN-170C^
FLTRI Road Glide F/I	88 CI	HD-8899	KN-171C*	FLHT Electra Glide Standard	88 CI	HD-1499	KN-171C*
FLTRSEI2 Screamin Eagle Road Glide 2 F/I	95 CI	HD-0800	KN-171C*	FLHTC Electra Glide Classic	88 CI	HD-1499	KN-171C*
FXD Dyna Super Glide	88 CI	HD-1499	KN-171C*	FLHTCI Electra Glide Classic F/I	88 CI	HD-8899	KN-171C*
FXDL Dyna Low Rider	88 CI	HD-1499	KN-171C*	FLHTCUI Electra Glide Ultra Classic F/I	88 CI	HD-8899	KN-171C*
FXDWG Dyna Wide Glide	88 CI	HD-1499	KN-171C*	FLSTC Heritage Softail Classic	82 CI	HD-1390	KN-170C^
FXDWG3	88 CI	HD-1499	KN-171C*	FLSTC Heritage Softail Classic - Non-US	82 CI	HD-1396	
FXDX Dyna Super Glide Sport	88 CI	HD-1499	KN-171C*	FLSTF Fat Boy	82 CI	HD-1390	KN-170C^
FXDXT Dyna Super Glide T-Sport	88 CI	HD-1499	KN-171C*	FLSTF Fat Boy - Non-US	82 CI	HD-1396	
FXST Softail Standard	88 CI	HD-1499	KN-171C*	FLSTS Heritage Springer	82 CI	HD-1390	KN-170C^
FXSTB Night Train	88 CI	HD-1499	KN-171C*	FLSTS Softail - Non-US	82 CI	HD-1396	
FXSTBI Night Train F/I	88 CI	HD-1499 ♦	KN-171C*	FLTR Road Glide	88 CI	HD-1499	KN-171C*
FXSTD Softail Deuce	88 CI	HD-1499	KN-171C*	FLTRI Road Glide F/I	88 CI	HD-8899	KN-171C*
FXSTDI Softail Deuce F/I	88 CI	HD-1499 ♦	KN-171C*	FXD Dyna Super Glide	88 CI	HD-1499	KN-171C*
FXSTI Softail Standard F/I	88 CI	HD-1499 ♦	KN-171C*	FXDL Dyna Low Rider	88 CI	HD-1499	KN-171C*
FXSTS Springer Softail	88 CI	HD-1499	KN-171C*	FXDS Dyna Convertible	88 CI	HD-1499	KN-171C*
FXSTSI Springer Softail F/I	88 CI	HD-1499 ♦	KN-171C*	FXDWG Dyna Wide Glide	88 CI	HD-1499	KN-171C*
XL53C Sportster Custom	54 CI		KN-170C^	FXDX Dyna Super Glide Sport	88 CI	HD-1499	KN-171C*
XL1200C Sportster Custom	74 CI	HD-1388	KN-170C^	FXST Softail - Non-US	82 CI	HD-1396	
XL1200S Sportster Sport	74 CI	HD-1388	KN-170C^	FXST Softail Standard	82 CI	HD-1390	
XLH883 Sportster	54 CI	HD-1388	KN-170C^	FXSTB Night Train	82 CI	HD-1390	KN-170C^
XLH883 Sportster Custom	54 CI	HD-1388	KN-170C^	FXSTB Softail - Non-US	82 CI	HD-1396	
XLH883 Sportster Hugger	54 CI	HD-1388	KN-170C^	FXSTC Softail Custom	82 CI	HD-1390	KN-170C^
XLH1200 Sportster	74 CI	HD-1388	KN-170C^	FXSTC Softail Custom - Non-US	82 CI	HD-1396	
2000 HARLEY DAVIDSON				1998 HARLEY DAVIDSON			
FLHR Road King	88 CI	HD-1499	KN-171C*	FLHR Road King	82 CI	HD-1390	KN-170C^
FLHRCI Road King Classic F/I	88 CI	HD-8899	KN-171C*	FLHRI Electra Glide Road King F/I	82 CI	HD-1395	
FLHRI Electra Glide Road King F/I	88 CI	HD-8899	KN-171C*	FLHT Electra Glide	82 CI		KN-170C^
FLHRI Road King F/I	88 CI	HD-8899		FLHT Electra Glide - Non-US	82 CI	HD-1396	
FLHT Electra Glide	82 CI		KN-171C*	FLHT Electra Glide Standard	82 CI	HD-1390	KN-170C^
FLHT Electra Glide Standard	88 CI	HD-1499	KN-171C*	FLHTC Electra Glide Classic	82 CI	HD-1390	KN-170C^
FLHTC Electra Glide Classic	88 CI	HD-1499	KN-171C*	FLHTC Electra Glide Classic - Non-US	82 CI	HD-1396	
FLHTCI Electra Glide Classic F/I	88 CI	HD-8899	KN-171C*	FLHTCI Electra Glide Classic F/I	82 CI	HD-1395	KN-170C^
FLHTCUI Electra Glide Ultra Classic F/I	88 CI	HD-8899	KN-171C*	FLHTCU Electra Glide Ultra Classic - Non-US	82 CI	HD-1396	
FLSTC Heritage Softail Classic	88 CI	HD-1499	KN-171C*	FLHTCUI Electra Glide Ultra Classic F/I	82 CI	HD-1395	KN-170C^
FLSTF Fat Boy	88 CI	HD-1499	KN-171C*	FLSTC Heritage Softail Classic	82 CI	HD-1390	KN-170C^
FLSTS Heritage Springer	88 CI	HD-1499	KN-171C*	FLSTC Heritage Softail Classic - Non-US	82 CI	HD-1396	
FLTR Road Glide	88 CI	HD-1499	KN-171C*	FLSTF Fat Boy	82 CI	HD-1390	KN-170C^
FLTRI Road Glide F/I	88 CI	HD-8899	KN-171C*	FLSTF Fat Boy - Non-US	82 CI	HD-1396	
FXD Dyna Super Glide	88 CI	HD-1499	KN-171C*	FLSTN Heritage Softail Special	82 CI	HD-1390	KN-170C^
FXDL Dyna Low Rider	88 CI	HD-1499	KN-171C*	FLSTS Heritage Springer	82 CI	HD-1390	KN-170C^
FXDS Dyna Convertible	88 CI	HD-1499	KN-171C*	FLSTS Softail - Non-US	82 CI	HD-1396	
FXDWG Dyna Wide Glide	88 CI	HD-1499	KN-171C*	FLTR Road Glide	82 CI	HD-1390	KN-170C^
FXDWG2	88 CI	HD-1499	KN-171C*	FLTRI Road Glide F/I	82 CI	HD-1395	KN-170C^
FXDX Dyna Super Glide Sport	88 CI	HD-1499	KN-171C*	FXD Dyna Super Glide	82 CI	HD-1390	KN-173C*
FXST Softail Standard	88 CI	HD-1499	KN-171C*	FXD Dyna Super Glide - Non-US	82 CI	HD-1396	
FXSTB Night Train	88 CI	HD-1499	KN-171C*				
FXSTC Softail Custom	82 CI		KN-171C*				
FXSTD Softail Deuce	88 CI	HD-1499	KN-171C*				
FXSTS Springer Softail	88 CI	HD-1499	KN-171C*				
XL53C Sportster Custom	54 CI	HD-1388	KN-170C^				
XL1200C Sportster Custom	74 CI	HD-1388	KN-170C^				
XL1200S Sportster Sport	74 CI	HD-1388	KN-170C^				
XLH883 Sportster	54 CI	HD-1388	KN-170C^				
XLH883 Sportster Custom	54 CI	HD-1388	KN-170C^				
XLH883 Sportster Hugger	54 CI	HD-1388	KN-170C^				
XLH883R Sportster Flat Track	54 CI	HD-1388	KN-170C^				
XLH1200 Sportster	74 CI	HD-1388	KN-170C^				

♦ Intake Available. See Pages 10-15 ^ Use KN-170 for Black * Change C to B for Black Applications updated daily at knfilters.com ®



American V-Twin - Air & Oil Filters

Vehicle	Engine	Air Filter	Oil Filter	Vehicle	Engine	Air Filter	Oil Filter
1998 HARLEY DAVIDSON				1996 HARLEY DAVIDSON			
FXDL Dyna Low Rider	82 CI	HD-1390	KN-173C*	FLHT Electra Glide	82 CI		KN-170C^
FXDL Dyna Low Rider - Non-US	82 CI	HD-1396		FLHT Electra Glide - Non-US	82 CI	HD-1396	
FXDS Dyna Convertible	82 CI	HD-1390	KN-173C*	FLHT Electra Glide Standard	82 CI	HD-1390	KN-170C^
FXDS Dyna Convertible - Non-US	82 CI	HD-1396		FLHTC Electra Glide Classic	82 CI	HD-1390	KN-170C^
FXDWG Dyna Wide Glide	82 CI	HD-1390	KN-173C*	FLHTC Electra Glide Classic - Non-US	82 CI	HD-1396	
FXDWG Dyna Wide Glide - Non-US	82 CI	HD-1396		FLHTCI Electra Glide Classic F/I	82 CI	HD-1395	KN-170C^
FXSTC Softail Custom	82 CI	HD-1390	KN-170C^	FLHTCU Electra Glide Ultra Classic	82 CI	HD-1390	KN-170C^
FXSTC Softail Custom - Non-US	82 CI	HD-1396		FLHTCU Electra Glide Ultra Classic - Non-US	82 CI	HD-1396	
FXSTS Springer Softail	82 CI	HD-1390	KN-170C^	FLHTCUI Electra Glide Ultra Classic F/I	82 CI	HD-1395	KN-170C^
FXSTS Springer Softail - Non-US	82 CI	HD-1396		FLSTC Heritage Softail Classic	82 CI	HD-1390	KN-170C^
XL1200C Sportster Custom	74 CI	HD-1388	KN-170C^	FLSTC Heritage Softail Classic - Non-US	82 CI	HD-1396	
XL1200S Sportster Sport	74 CI	HD-1388	KN-170C^	FLSTF Fat Boy	82 CI	HD-1390	KN-170C^
XLH883 Sportster	54 CI	HD-1388	KN-170C^	FLSTF Fat Boy - Non-US	82 CI	HD-1396	
XLH883 Sportster Hugger	54 CI	HD-1388	KN-170C^	FLSTN Heritage Softail Special	82 CI	HD-1390	KN-170C^
XLH1200 Sportster	74 CI	HD-1388	KN-170C^	FLSTN Heritage Softail Special - Non-US	82 CI	HD-1396	
1997 HARLEY DAVIDSON				1995 HARLEY DAVIDSON			
FLHR Road King	82 CI	HD-1390	KN-170C^	FLHR Road King	82 CI	HD-1390	
FLHR Road King - Non-US	82 CI	HD-1396		FLHR Road King - Non-US	82 CI	HD-1396	
FLHRI Electra Glide Road King F/I	82 CI	HD-1395		FLHT Electra Glide - Non-US	82 CI	HD-1396	
FLHT Electra Glide	82 CI		KN-170C^	FLHT Electra Glide Standard	82 CI	HD-1390	KN-170C^
FLHT Electra Glide - Non-US	82 CI	HD-1396		FLHTC Electra Glide Classic	82 CI	HD-1390	KN-170C^
FLHT Electra Glide Standard	82 CI	HD-1390	KN-170C^	FLHTC Electra Glide Classic - Non-US	82 CI	HD-1396	
FLHTC Electra Glide Classic	82 CI	HD-1390	KN-170C^	FLHTCI Electra Glide Classic F/I	82 CI	HD-1395	KN-170C^
FLHTC Electra Glide Classic - Non-US	82 CI	HD-1396		FLHTCU Electra Glide Ultra Classic	82 CI	HD-1390	KN-170C^
FLHTCI Electra Glide Classic F/I	82 CI	HD-1395	KN-170C^	FLHTCU Electra Glide Ultra Classic - Non-US	82 CI	HD-1396	
FLHTCU Electra Glide Ultra Classic	82 CI	HD-1390	KN-170C^	FLHTCUI Electra Glide Ultra Classic F/I	82 CI	HD-1395	KN-170C^
FLHTCU Electra Glide Ultra Classic - Non-US	82 CI	HD-1396		FLSTC Heritage Softail Classic	82 CI	HD-1390	KN-170C^
FLHTCUI Electra Glide Ultra Classic	82 CI	HD-1395	KN-170C^	FLSTC Heritage Softail Classic - Non-US	82 CI	HD-1396	
FLSTC Heritage Softail Classic	82 CI	HD-1390	KN-170C^	FLSTF Fat Boy	82 CI	HD-1390	KN-170C^
FLSTC Heritage Softail Classic - Non-US	82 CI	HD-1396		FLSTF Fat Boy - Non-US	82 CI	HD-1396	
FLSTF Fat Boy	82 CI	HD-1390	KN-170C^	FLSTN Heritage Softail Special	82 CI	HD-1390	KN-170C^
FLSTF Fat Boy - Non-US	82 CI	HD-1396		FLSTS Heritage Springer	82 CI	HD-1390	KN-170C^
FLSTN Heritage Softail Special	82 CI	HD-1390	KN-170C^	FLSTS Softail - Non-US	82 CI	HD-1396	
FLSTS Heritage Springer	82 CI	HD-1390	KN-170C^	FXD Dyna Super Glide	82 CI	HD-1390	KN-173C*
FLSTS Softail - Non-US	82 CI	HD-1396		FXD Dyna Super Glide - Non-US	82 CI	HD-1396	
FXD Dyna Super Glide	82 CI	HD-1390	KN-173C*	FXDL Dyna Low Rider	82 CI	HD-1390	KN-173C*
FXD Dyna Super Glide - Non-US	82 CI	HD-1396		FXDL Dyna Low Rider - Non-US	82 CI	HD-1396	
FXDL Dyna Low Rider	82 CI	HD-1390	KN-173C*	FXDS Dyna Convertible	82 CI	HD-1390	KN-173C*
FXDL Dyna Low Rider - Non-US	82 CI	HD-1396		FXDS Dyna Convertible - Non-US	82 CI	HD-1396	
FXDS Dyna Convertible	82 CI	HD-1390	KN-173C*	FXDWG Dyna Wide Glide	82 CI	HD-1390	KN-173C*
FXDS Dyna Convertible - Non-US	82 CI	HD-1396		FXDWG Dyna Wide Glide - Non-US	82 CI	HD-1396	
FXDWG Dyna Wide Glide	82 CI	HD-1390	KN-173C*	FXSTC Softail Custom	82 CI	HD-1390	KN-170C^
FXDWG Dyna Wide Glide - Non-US	82 CI	HD-1396		FXSTC Softail Custom - Non-US	82 CI	HD-1396	
FXSTC Softail Custom	82 CI	HD-1390	KN-170C^	FXSTS Springer Softail	82 CI	HD-1390	KN-170C^
FXSTC Softail Custom - Non-US	82 CI	HD-1396		FXSTS Springer Softail - Non-US	82 CI	HD-1396	
FXSTS Springer Softail	82 CI	HD-1390	KN-170C^	FXSTSB Bad Boy	82 CI	HD-1390	KN-170C^
FXSTS Springer Softail - Non-US	82 CI	HD-1396		FXSTSB Bad Boy - Non-US	82 CI	HD-1396	
FXSTSB Bad Boy	82 CI	HD-1390	KN-170C^	XL1200C Sportster Custom	74 CI	HD-1388	KN-170C^
FXSTSB Bad Boy - Non-US	82 CI	HD-1396		XL1200S Sportster Sport	74 CI	HD-1388	KN-170C^
XL1200C Sportster Custom	74 CI	HD-1388	KN-170C^	XLH883 Sportster	54 CI	HD-1388	KN-170C^
XL1200S Sportster Sport	74 CI	HD-1388	KN-170C^	XLH883 Sportster Hugger	54 CI	HD-1388	KN-170C^
XLH883 Sportster	54 CI	HD-1388	KN-170C^	XLH1200 Sportster	74 CI	HD-1388	KN-170C^
XLH883 Sportster Hugger	54 CI	HD-1388	KN-170C^	1996 HARLEY DAVIDSON			
XLH1200 Sportster	74 CI	HD-1388	KN-170C^	FLHR Road King	82 CI	HD-1390	
1996 HARLEY DAVIDSON				FLHR Road King - Non-US	82 CI	HD-1396	
FLHR Road King	82 CI	HD-1390	KN-170C^	FLHT Electra Glide - Non-US	82 CI	HD-1396	
FLHR Road King - Non-US	82 CI	HD-1396		FLHT Electra Glide Standard	82 CI	HD-1390	KN-170C^
FLHRI Electra Glide Road King F/I	82 CI	HD-1395	KN-171C*	FLHTC Electra Glide Classic	82 CI	HD-1390	KN-170C^
				FLHTC Electra Glide Classic - Non-US	82 CI	HD-1396	
				FLHTCI Ultra Classic Electra Glide Annv.	82 CI	HD-1395	
				FLHTCU Electra Glide Ultra Classic	82 CI	HD-1390	KN-170C^
				FLHTCU Electra Glide Ultra Classic - Non-US	82 CI	HD-1396	
				FLHTCUI Electra Glide Ultra Classic F/I	82 CI		KN-170C^
				FLSTC Heritage Softail Classic	82 CI	HD-1390	KN-170C^
				FLSTC Heritage Softail Classic - Non-US	82 CI	HD-1396	
				FLSTF Fat Boy	82 CI	HD-1390	KN-170C^
				FLSTF Fat Boy - Non-US	82 CI	HD-1396	
				FLSTN Heritage Softail Nostalgia	82 CI	HD-1390	
				FLSTN Heritage Softail Special	82 CI		KN-170C^
				FLSTN Heritage Softail Special - Non-US	82 CI	HD-1396	

◆ Intake Available. See Pages 10-15 ^ Use KN-170 for Black * Change C to B for Black Applications updated daily at knfilters.com ®

American V-Twin - Air & Oil Filters



Vehicle	Engine	Air Filter	Oil Filter
1995 HARLEY DAVIDSON			
FLTCU Ultra Tour Glide Classic	82 CI	HD-1390	KN-170C^
FXD Dyna Super Glide	82 CI	HD-1390	
FXD Dyna Super Glide - Non-US	82 CI	HD-1396	
FXDL Dyna Low Rider	82 CI	HD-1390	KN-173C*
FXDL Dyna Low Rider - Non-US	82 CI	HD-1396	
FXDS Dyna Convertible - Non-US	82 CI	HD-1396	
FXDS Dyna Low Rider Conv.	82 CI	HD-1390	
FXDWG Dyna Wide Glide	82 CI	HD-1390	KN-173C*
FXDWG Dyna Wide Glide - Non-US	82 CI	HD-1396	
FXSTC Softail Custom	82 CI	HD-1390	KN-170C^
FXSTC Softail Custom - Non-US	82 CI	HD-1396	
FXSTS Springer Softail	82 CI	HD-1390	KN-170C^
FXSTS Springer Softail - Non-US	82 CI	HD-1396	
FXSTSB Bad Boy	82 CI	HD-1390	
FXSTSB Bad Boy - Non-US	82 CI	HD-1396	
XLH883 Sportster	54 CI	HD-1388	KN-170C^
XLH883 Sportster Deluxe	54 CI	HD-1388	KN-170C^
XLH883 Sportster Hugger	54 CI	HD-1388	KN-170C^
XLH1200 Sportster	74 CI	HD-1388	KN-170C^

Vehicle	Engine	Air Filter	Oil Filter
1994 HARLEY DAVIDSON			
FLHS Electra Glide Sport	82 CI		KN-170C^
FLHTC Electra Glide Classic	82 CI	HD-1390	KN-170C^
FLHTCU Electra Glide Ultra Classic	82 CI	HD-1390	KN-170C^
FLHTCUI Electra Glide Ultra Classic F/I	82 CI		KN-170C^
FLSTC Heritage Softail Classic	82 CI	HD-1390	KN-170C^
FLSTF Fat Boy	82 CI	HD-1390	KN-170C^
FLSTN Heritage Softail Nostalgia	82 CI	HD-1390	
FLSTN Heritage Softail Special	82 CI		KN-170C^
FLTCU Ultra Tour Glide Classic	82 CI	HD-1390	KN-170C^
FXDL Dyna Low Rider	82 CI	HD-1390	KN-173C*
FXDS Dyna Low Rider Conv.	82 CI	HD-1390	
FXDWG Dyna Wide Glide	82 CI	HD-1390	KN-173C*
FXLR Low Rider Custom	82 CI	HD-1390	KN-170C^
FXR Super Glide	82 CI		KN-170C^
FXRS Low Rider	82 CI		KN-170C^
FXRS Low Rider Conv.	82 CI		KN-170C^
FXRS-SP Low Rider Sport	82 CI	HD-1390	KN-170C^
FXRT Sport Glide	82 CI	HD-1390	
FXSTC Softail Custom	82 CI	HD-1390	KN-170C^
FXSTS Springer Softail	82 CI	HD-1390	KN-170C^
XLH883 Sportster	54 CI	HD-1388	KN-170C^
XLH883 Sportster Deluxe	54 CI	HD-1388	KN-170C^
XLH883 Sportster Hugger	54 CI	HD-1388	KN-170C^
XLH1200 Sportster	74 CI	HD-1388	KN-170C^

Vehicle	Engine	Air Filter	Oil Filter
1993 HARLEY DAVIDSON			
FLHS Electra Glide Sport	82 CI	HD-1390	KN-170C^
FLHTC Classic Anniversary	82 CI	HD-1390	
FLHTC Electra Glide Classic	82 CI	HD-1390	KN-170C^
FLHTCU Electra Glide Ultra Classic	82 CI	HD-1390	KN-170C^
FLHTCU Electra Glide Ultra Classic Annv.	82 CI	HD-1390	KN-170C^
FLHTCUI Electra Glide Ultra Classic F/I	82 CI		KN-170C^
FLSTC Heritage Softail Classic	82 CI	HD-1390	KN-170C^
FLSTF Fat Boy	82 CI	HD-1390	KN-170C^
FLSTN Heritage Softail Nostalgia	82 CI	HD-1390	
FLTCU Ultra Tour Glide Annv.	82 CI	HD-1390	KN-170C^
FLTCU Ultra Tour Glide Classic	82 CI	HD-1390	KN-170C^
FXDL Dyna Low Rider	82 CI	HD-1390	KN-173C*
FXDWG Dyna Wide Glide	82 CI	HD-1390	KN-173C*
FXLR Low Rider Custom	82 CI	HD-1390	KN-170C^
FXLR Low Rider Custom Annv.	82 CI	HD-1390	KN-170C^
FXR Super Glide	82 CI	HD-1390	KN-170C^

Vehicle	Engine	Air Filter	Oil Filter
1993 HARLEY DAVIDSON			
FXRS Low Rider	82 CI		KN-170C^
FXRS Low Rider Conv.	82 CI	HD-1390	KN-170C^
FXRS-SP Low Rider Sport	82 CI	HD-1390	KN-170C^
FXSTC Softail Custom	82 CI	HD-1390	KN-170C^
FXSTS Springer Softail	82 CI	HD-1390	KN-170C^
XLH Sportster Annv.	74 CI	HD-1388	KN-170C^
XLH883 Sportster	54 CI	HD-1388	KN-170C^
XLH883 Sportster Deluxe	54 CI	HD-1388	KN-170C^
XLH883 Sportster Hugger	54 CI	HD-1388	KN-170C^
XLH1200 Sportster	74 CI	HD-1388	KN-170C^

Vehicle	Engine	Air Filter	Oil Filter
1992 HARLEY DAVIDSON			
FLHS Electra Glide Sport	82 CI	HD-1390	KN-170C^
FLHTC Electra Glide Classic	82 CI	HD-1390	KN-170C^
FLHTCU Electra Glide Ultra Classic	82 CI	HD-1390	KN-170C^
FLHTCUI Electra Glide Ultra Classic F/I	82 CI		KN-170C^
FLSTC Heritage Softail Classic	82 CI	HD-1390	KN-170C^
FLSTF Fat Boy	82 CI	HD-1390	KN-170C^
FLTC Tour Glide Classic	82 CI		KN-170C^
FLTCU Ultra Tour Glide Classic	82 CI	HD-1390	KN-170C^
FXDB Dyna Glide Daytona	82 CI	HD-1390	KN-173C*
FXDC Dyna Glide Custom	82 CI	HD-1390	KN-173C*
FXLR Low Rider Custom	82 CI	HD-1390	KN-170C^
FXR Super Glide	82 CI	HD-1390	KN-170C^
FXRS Low Rider	82 CI	HD-1390	KN-170C^
FXRS Low Rider Conv.	82 CI	HD-1390	KN-170C^
FXRS-SP Low Rider Sport	82 CI	HD-1390	KN-170C^
FXRT Sport Glide	82 CI	HD-1390	
FXSTC Softail Custom	82 CI	HD-1390	KN-170C^
FXSTS Springer Softail	82 CI	HD-1390	KN-170C^
XLH883 Sportster	54 CI	HD-1388	KN-170C^
XLH883 Sportster Deluxe	54 CI	HD-1388	KN-170C^
XLH883 Sportster Hugger	54 CI	HD-1388	KN-170C^
XLH1200 Sportster	74 CI	HD-1388	KN-170C^

Vehicle	Engine	Air Filter	Oil Filter
1991 HARLEY DAVIDSON			
FLHS Electra Glide Sport	82 CI	HD-1390	KN-170C^
FLHTC Electra Glide Classic	82 CI	HD-1390	KN-170C^
FLHTCU Electra Glide Ultra Classic	82 CI	HD-1390	KN-170C^
FLHTCUI Electra Glide Ultra Classic F/I	82 CI		KN-170C^
FLSTC Heritage Softail Classic	82 CI	HD-1390	KN-170C^
FLSTF Fat Boy	82 CI	HD-1390	KN-170C^
FLTC Tour Glide Classic	82 CI	HD-1390	KN-170C^
FLTCU Ultra Tour Glide Classic	82 CI	HD-1390	KN-170C^
FXDB Dyna Glide Sturgis	82 CI	HD-1390	KN-173C*
FXLR Low Rider Custom	82 CI	HD-1390	KN-170C^
FXR Super Glide	82 CI	HD-1390	KN-170C^
FXRS Low Rider	82 CI	HD-1390	KN-170C^
FXRS Low Rider Conv.	82 CI	HD-1390	KN-170C^
FXRS-SP Low Rider Sport	82 CI	HD-1390	KN-170C^
FXRT Sport Glide	82 CI	HD-1390	
FXSTC Softail Custom	82 CI	HD-1390	KN-170C^
FXSTS Springer Softail	82 CI	HD-1390	KN-170C^
XLH883 Sportster	54 CI	HD-1388	KN-170C^
XLH883 Sportster Deluxe	54 CI	HD-1388	KN-170C^
XLH883 Sportster Hugger	54 CI	HD-1388	KN-170C^
XLH1200 Sportster	74 CI	HD-1388	KN-170C^

Vehicle	Engine	Air Filter	Oil Filter
1990 HARLEY DAVIDSON			
FLHS Electra Glide Sport	82 CI	HD-1390	KN-170C^
FLHTC Electra Glide Classic	82 CI	HD-1390	KN-170C^
FLHTCU Electra Glide Ultra Classic	82 CI	HD-1390	KN-170C^

◆ Intake Available. See Pages 10-15 ^ Use KN-170 for Black * Change C to B for Black Applications updated daily at knfilters.com ®



American V-Twin - Air & Oil Filters

Vehicle	Engine	Air Filter	Oil Filter	Vehicle	Engine	Air Filter	Oil Filter
1990 HARLEY DAVIDSON				1988 HARLEY DAVIDSON			
FLHTCUI Electra Glide Ultra Classic F/I	82 CI		KN-170C^	FXRS Low Rider Sport	82 CI	HD-2086	
FLST Heritage Softail	82 CI	HD-1390	KN-170C^	FXRT Sport Glide	82 CI	HD-2086	KN-170C^
FLSTC Heritage Softail Classic	82 CI	HD-1390	KN-170C^	FXST Softail	82 CI	HD-2086	KN-170C^
FLSTF Fat Boy	82 CI	HD-1390	KN-170C^	FXSTC Softail Custom	82 CI	HD-2086	KN-170C^
FLT	82 CI		KN-170C^	FXSTS Springer Softail	82 CI	HD-2086	KN-170C^
FLTC Tour Glide Classic	82 CI	HD-1390	KN-170C^	XLH883 Sportster	54 CI	HD-1388	KN-170C^
FLTCU Ultra Tour Glide Classic	82 CI	HD-1390	KN-170C^	XLH883 Sportster Deluxe	54 CI	HD-1388	KN-170C^
FXLR Low Rider Custom	82 CI	HD-1390	KN-170C^	XLH883 Sportster Hugger	54 CI	HD-1388	KN-170C^
FXR Super Glide	82 CI	HD-1390	KN-170C^	XLH1000 Sportster	61 CI		KN-170C^
FXRS Low Rider	82 CI	HD-1390	KN-170C^	XLH1100 Sportster	67 CI		KN-170C^
FXRS Low Rider Conv.	82 CI	HD-1390	KN-170C^	XLH1200 Sportster	74 CI	HD-1388	KN-170C^
FXRS-SP Low Rider Sport	82 CI	HD-1390	KN-170C^	1987 HARLEY DAVIDSON			
FXRT Sport Glide	82 CI	HD-1390	KN-170C^	FLHS Electra Glide Sport	82 CI	HD-2086	KN-170C^
FXST Softail	82 CI	HD-1390	KN-170C^	FLHT Electra Glide	82 CI	HD-2086	KN-170C^
FXSTC Softail Custom	82 CI	HD-1390	KN-170C^	FLHTC Chrome TT	82 CI	HD-2086	
FXSTS Springer Softail	82 CI	HD-1390	KN-170C^	FLHTC Electra Glide Classic	82 CI	HD-2086	KN-170C^
XLH883 Sportster	54 CI	HD-1388	KN-170C^	FLHTCU Electra Glide Ultra Classic	82 CI		KN-170C^
XLH883 Sportster Deluxe	54 CI	HD-1388	KN-170C^	FLST Heritage Softail	82 CI	HD-2086	KN-170C^
XLH883 Sportster Hugger	54 CI	HD-1388	KN-170C^	FLSTC Heritage Softail Classic	82 CI		KN-170C^
XLH1200 Sportster	74 CI	HD-1388	KN-170C^	FLT	82 CI		KN-170C^
1989 HARLEY DAVIDSON				FLTC Chrome TT	82 CI	HD-2086	KN-170C^
FLHS Electra Glide Sport	82 CI	HD-2086	KN-170C^	FLTC Tour Glide Classic	82 CI	HD-2086	KN-170C^
FLHT Electra Glide	82 CI		KN-170C^	FLTCU Ultra Tour Glide Classic	82 CI		KN-170C^
FLHTC Electra Glide Classic	82 CI	HD-2086	KN-170C^	FXLR Low Rider Custom	82 CI	HD-2086	KN-170C^
FLHTCU Electra Glide Ultra Classic	82 CI	HD-2086	KN-170C^	FXR Super Glide	82 CI	HD-2086	KN-170C^
FLHTCUI Electra Glide Ultra Classic F/I	82 CI		KN-170C^	FXRC Low Glide Custom	82 CI	HD-2086	KN-170C^
FLST Heritage Softail	82 CI	HD-2086	KN-170C^	FXRS Low Rider	82 CI	HD-2086	KN-170C^
FLSTC Heritage Softail Classic	82 CI	HD-2086	KN-170C^	FXRS Low Rider Sport	82 CI	HD-2086	
FLSTF Fat Boy	82 CI		KN-170C^	FXRT Sport Glide	82 CI	HD-2086	KN-170C^
FLT	82 CI		KN-170C^	FXST Softail	82 CI	HD-2086	KN-170C^
FLTC Tour Glide Classic	82 CI	HD-2086	KN-170C^	FXSTC Softail Custom	82 CI	HD-2086	KN-170C^
FLTCU Ultra Tour Glide Classic	82 CI	HD-2086	KN-170C^	FXSTS Springer Softail	82 CI		KN-170C^
FXLR Low Rider Custom	82 CI	HD-2086	KN-170C^	XLH883 Sportster	54 CI	HD-2085	KN-170C^
FXR Super Glide	82 CI	HD-2086	KN-170C^	XLH883 Sportster Deluxe	54 CI	HD-2085	KN-170C^
FXRS Low Rider	82 CI	HD-2086	KN-170C^	XLH883 Sportster Hugger F/I	54 CI	HD-2085	KN-170C^
FXRS Low Rider Conv.	82 CI	HD-2086	KN-170C^	XLH1000 Sportster	61 CI		KN-170C^
FXRS-SP Low Rider Sport	82 CI	HD-2086	KN-170C^	XLH1100 Sportster	67 CI	HD-2085	KN-170C^
FXRT Sport Glide	82 CI	HD-2086	KN-170C^	1986 HARLEY DAVIDSON			
FXST Softail	82 CI	HD-2086	KN-170C^	FLHT Electra Glide	82 CI	HD-2086	KN-170C^
FXSTC Softail Custom	82 CI	HD-2086	KN-170C^	FLHTC Electra Glide Classic	82 CI	HD-2086	KN-170C^
FXSTS Springer Softail	82 CI	HD-2086	KN-170C^	FLHTC Liberty	82 CI	HD-2086	
XLH883 Sportster	54 CI	HD-1388	KN-170C^	FLST Heritage Softail	82 CI	HD-2086	
XLH883 Sportster Deluxe	54 CI	HD-1388	KN-170C^	FLSTC Heritage Softail Classic	82 CI		KN-170C^
XLH883 Sportster Hugger	54 CI	HD-1388	KN-170C^	FLT	82 CI		KN-170C^
XLH1200 Sportster	74 CI	HD-1388	KN-170C^	FLTC Tour Glide Classic	82 CI	HD-2086	KN-170C^
1988 HARLEY DAVIDSON				FXR Super Glide	82 CI	HD-2086	KN-170C^
FLHS Electra Glide Sport	82 CI	HD-2086	KN-170C^	FXRC Low Glide Custom	82 CI	HD-2086	
FLHT Electra Glide	82 CI		KN-170C^	FXRD Grand Touring	82 CI	HD-2086	KN-170C^
FLHTC Chrome	82 CI	HD-2086		FXRS Low Rider	82 CI	HD-2086	
FLHTC Electra Glide Classic	82 CI	HD-2086	KN-170C^	FXRS Low Rider Sport	82 CI	HD-2086	
FLHTCU Electra Glide Ultra Classic	82 CI		KN-170C^	FXRT Sport Glide	82 CI	HD-2086	KN-170C^
FLST Heritage Softail	82 CI	HD-2086	KN-170C^	FXST Softail	82 CI	HD-2086	
FLSTC Heritage Softail Classic	82 CI	HD-2086	KN-170C^	FXSTC Softail Custom	82 CI	HD-2086	
FLT	82 CI		KN-170C^	FXWG Wide Glide	82 CI	HD-2086	KN-172C*
FLTC Chrome	82 CI	HD-2086	KN-170C^	XLH883 Sportster	54 CI	HD-2085	KN-170C^
FLTC Tour Glide Classic	82 CI	HD-2086	KN-170C^	XLH883 Sportster Deluxe	54 CI	HD-2085	KN-170C^
FLTCU Ultra Tour Glide Classic	82 CI		KN-170C^	XLH1000 Sportster	61 CI		KN-170C^
FXLR Low Rider Custom	82 CI	HD-2086	KN-170C^	XLH1100 Sportster	67 CI	HD-2085	KN-170C^
FXR Super Glide	82 CI	HD-2086	KN-170C^	1985 HARLEY DAVIDSON			
FXRS Low Rider	82 CI	HD-2086	KN-170C^	FLHT Electra Glide	82 CI		KN-170C^
				FLHTC Electra Glide Classic	82 CI		KN-170C^

◆ Intake Available. See Pages 10-15 ^ Use KN-170 for Black * Change C to B for Black Applications updated daily at knfilters.com ®

Partial Listing: Complete Listing of Vehicles and Parts at KNFILTERS.COM or call 1-800-858-3333

American V-Twin - Air & Oil Filters



Vehicle	Engine	Air Filter	Oil Filter	Vehicle	Engine	Air Filter	Oil Filter
1985 HARLEY DAVIDSON				1983 HARLEY DAVIDSON			
FLHTC Electra Glide Classic - Non-US	82 CI	HD-2084	KN-170C^	FXDG Disc Glide	82 CI	HD-2078	
FLSTC Heritage Softail Classic	82 CI		KN-170C^	FXE Super Glide	82 CI	HD-2078	KN-172C*
FLT	82 CI		KN-170C^	FXR Super Glide II	82 CI	HD-2078	KN-170C^
FLTC Tour Glide Classic	82 CI	HD-2084	KN-170C^	FXRS Low Glide	82 CI		KN-170C^
FXEF Super Glide Fat Bob	82 CI	HD-2084	KN-172C*	FXRS Super Glide II	82 CI	HD-2078	
FXR Super Glide	82 CI		KN-170C^	FXRT Sport Glide	82 CI	HD-2078	KN-170C^
FXRC Low Glide Custom	82 CI	HD-2084		FXSB Low Rider	82 CI	HD-2078	
FXRS Low Glide	82 CI	HD-2084		FXWG Wide Glide	82 CI	HD-2078	KN-172C*
FXRT Sport Glide	82 CI	HD-2084	KN-170C^	XLH883	54 CI		KN-172C*
FXSB Low Rider	82 CI	HD-2084		XLH1000 Sportster	61 CI	HD-2076	
FXST Softail	82 CI	HD-2084	KN-170C^	XLH1100 Sportster	67 CI		KN-172C*
FXWG Wide Glide	82 CI	HD-2084	KN-172C*	XLH1200 Sportster	74 CI		KN-172C*
XL1000 Sportster - from late 1984	61 CI		KN-170C^	XLS1000 Roadster	61 CI		KN-172C*
XLH1000 Sportster	61 CI	HD-2076		XR1000 Cafe Racer - Req Both Filters, w/o Vent	61 CI	RU-1370	
XLS1000 Roadster - from late 1984	61 CI		KN-170C^	XR1000 Cafe Racer - Req Both Filters, w/Vent	61 CI	RU-1371	
XLX61 Sportster - from late 1984	61 CI		KN-170C^	1982 HARLEY DAVIDSON			
XR1000 Cafe Racer - Req Both Filters, w/o Vent	61 CI	RU-1370		FLH Electra Glide	82 CI	HD-2078	KN-172C*
XR1000 Cafe Racer - Req Both Filters, w/Vent	61 CI	RU-1371		FLHC Electra Glide Classic	82 CI	HD-2078	KN-172C*
1984 HARLEY DAVIDSON				FLHF Sport Glide II	82 CI	HD-2078	
FLH Electra Glide	82 CI	HD-2084	KN-172C*	FLHS Sport Glide	82 CI	HD-2078	KN-172C*
FLH Electra Glide Special	82 CI	HD-2084		FLHTCU Electra Glide Ultra Classic	82 CI		KN-170C^
FLHS	82 CI	HD-2084	KN-172C*	FLSTC Heritage Softail Classic	82 CI		KN-170C^
FLHT Electra Glide - from late 1984	82 CI		KN-170C^	FLT	82 CI		KN-170C^
FLHTC Electra Glide Classic	82 CI		KN-170C^	FLT80 Tour Glide	80 CI	HD-2078	KN-170C^
FLHTC Electra Glide Classic - Non-US	82 CI	HD-2084	KN-170C^	FLTC Tour Glide Classic	82 CI	HD-2078	KN-170C^
FLHX Electra Glide Special	82 CI	HD-2084		FXB Sturgis	82 CI	HD-2078	KN-173C*
FLSTC Heritage Softail Classic	82 CI		KN-170C^	FXE Super Glide	82 CI	HD-2078	KN-172C*
FLT	82 CI		KN-170C^	FXR Super Glide II	82 CI	HD-2078	KN-170C^
FLTC Tour Glide Classic	82 CI	HD-2084	KN-170C^	FXRS Low Glide	82 CI		KN-170C^
FXE Super Glide	82 CI	HD-2084	KN-172C*	FXRS Super Glide II	82 CI	HD-2078	
FXEF Super Glide Fat Bob	82 CI	HD-2084	KN-172C*	FXS Low Rider	82 CI	HD-2078	
FXR Super Glide	82 CI		KN-170C^	FXWG Wide Glide	82 CI	HD-2078	KN-172C*
FXRDG Disc Glide	82 CI	HD-2084		XLH883	54 CI		KN-172C*
FXRS Low Glide	82 CI	HD-2084		XLH1000 Sportster	61 CI	HD-2078	
FXRT Sport Glide	82 CI	HD-2084	KN-170C^	XLH1100 Sportster	67 CI		KN-172C*
FXSB Low Rider	82 CI	HD-2084		XLH1200 Sportster	74 CI		KN-172C*
FXST Softail	82 CI	HD-2084	KN-170C^	XLHA Sportster Annv.	61 CI	HD-2078	
FXWG Wide Glide	82 CI	HD-2084	KN-172C*	XLS1000 Roadster	61 CI		KN-172C*
XL1000 Sportster - from late 1984	61 CI		KN-170C^	1981 HARLEY DAVIDSON			
XLH883	54 CI		KN-172C*	FLH Electra Glide	82 CI	HD-2078	
XLH1000 Sportster	61 CI	HD-2076		FLHC Electra Glide Classic	82 CI	HD-2078	
XLH1100 Sportster - to early 1984	67 CI		KN-172C*	FLHTCU Electra Glide Ultra Classic	82 CI		KN-170C^
XLH1200 Sportster - to early 1984	74 CI		KN-172C*	FLSTC Heritage Softail Classic	82 CI		KN-170C^
XLS1000 Roadster - from late 1984	61 CI		KN-170C^	FLT	82 CI		KN-170C^
XLS1000 Roadster - to early 1984	61 CI		KN-172C*	FLT80 Tour Glide	80 CI	HD-2078	KN-170C^
XLX61 Sportster - from late 1984	61 CI		KN-170C^	FLTC Tour Glide Classic	82 CI	HD-2078	KN-170C^
XR1000 Cafe Racer - Req Both Filters, w/o Vent	61 CI	RU-1370		FXE Super Glide	82 CI	HD-2078	
XR1000 Cafe Racer - Req Both Filters, w/Vent	61 CI	RU-1371		FXEF Fat Bob	82 CI	HD-2078	
1983 HARLEY DAVIDSON				FXH Electra Glide	82 CI	HD-2078	
FLH Electra Glide	82 CI	HD-2078	KN-172C*	FXS Low Rider	82 CI	HD-2078	
FLHS Super Glide	82 CI	HD-2078	KN-172C*	FXWG Wide Glide	82 CI	HD-2078	
FLHT Electra Glide	82 CI	HD-2078		XLH883	54 CI		KN-172C*
FLHTC Electra Glide Classic	82 CI	HD-2078		XLH1000 Sportster	61 CI	HD-2078	
FLSTC Heritage Softail Classic	82 CI		KN-170C^	XLH1100 Sportster	67 CI		KN-172C*
FLT	82 CI		KN-170C^	XLH1200 Sportster	74 CI		KN-172C*
FLT80 Tour Glide	80 CI	HD-2078	KN-170C^	XLS1000 Roadster	61 CI		KN-172C*
FLTC Tour Glide Classic	82 CI	HD-2078	KN-170C^	1980 HARLEY DAVIDSON			
1985 HARLEY DAVIDSON				FLH Electra Glide	74 CI	HD-2078	KN-178
FLH Electra Glide	82 CI	HD-2078	KN-172C*	FLH Electra Glide Classic	82 CI	HD-2078	
FLHTC Electra Glide Classic	82 CI	HD-2078		FLHTCU Electra Glide Ultra Classic	82 CI		KN-170C^
FLSTC Heritage Softail Classic	82 CI		KN-170C^				
FLT	82 CI		KN-170C^				
FLT80 Tour Glide	80 CI	HD-2078	KN-170C^				
FLTC Tour Glide Classic	82 CI	HD-2078	KN-170C^				

♦ Intake Available. See Pages 10-15 ^ Use KN-170 for Black * Change C to B for Black Applications updated daily at knfilters.com ®



American V-Twin - Air & Oil Filters

Vehicle	Engine	Air Filter	Oil Filter
1980 HARLEY DAVIDSON			
FLSTC Heritage Softail Classic	82 CI		KN-170C^
FLT	82 CI		KN-170C^
FLT80 Tour Glide	82 CI	HD-2078	KN-170C^
FLTC Tour Glide Classic	82 CI		KN-170C^
FXB Sturgis	82 CI	HD-2078	KN-173C*
FXE Super Glide	74 CI	HD-2078	
FXE Fat Bob	82 CI	HD-2078	
FXH Electra Glide	82 CI	HD-2078	
FXS Low Rider	82 CI	HD-2078	
FXWG Wide Glide	82 CI	HD-2078	
XLH883	54 CI		KN-172C*
XLH1000 Sportster	61 CI	HD-2078	
XLH1100 Sportster	67 CI		KN-172C*
XLH1200 Sportster	74 CI		KN-172C*
XLS1000 Roadster	61 CI		KN-172C*

1979 HARLEY DAVIDSON			
FLH Electra Glide	74 CI	HD-2078	KN-178
FLH Electra Glide Classic	82 CI	HD-2078	
FX Super Glide	74 CI	HD-2078	
FXE Super Glide	74 CI	HD-2078	
FXE Fat Bob	74 CI	HD-2078	
FXE Fat Bob	82 CI	HD-2078	
FXS Low Rider	74 CI	HD-2078	
FXS Low Rider	82 CI	HD-2078	
XLH1000 Sportster	61 CI	HD-2078	

1978 HARLEY DAVIDSON			
FLH Electra Glide	74 CI	HD-2075	KN-178
FX Super Glide	74 CI	HD-2076	
FXE Super Glide - Early Models	74 CI	HD-2076	
FXE Super Glide - Late Models	74 CI	HD-2078	
FXS Low Rider	74 CI	HD-2076	
KH	900		KN-178
XL	900		KN-178
XLCH1000 Sportster	61 CI	HD-2076	KN-178
XLH Sportster Annv.	61 CI	HD-2076	KN-178
XLH1000 Sportster	61 CI	HD-2076	KN-178

1977 HARLEY DAVIDSON			
FLH Electra Glide	74 CI	HD-2075	KN-178
FLH Electra Glide Classic	74 CI	HD-2075	
FLHS Sport Glide	74 CI	HD-2075	KN-178
FX Super Glide	74 CI	HD-2076	
FXE Super Glide	74 CI	HD-2076	
FXS Low Rider	74 CI	HD-2076	
KH	900		KN-178
XL	900		KN-178
XLCH1000 Sportster	61 CI	HD-2076	KN-178
XLH1000 Sportster	61 CI	HD-2076	KN-178

1976 HARLEY DAVIDSON			
FLH Electra Glide	74 CI	HD-2075	KN-178
FXE Super Glide	74 CI	HD-2076	
FXS Low Rider	74 CI	HD-2076	
KH	900		KN-178
XL	900		KN-178
XLCH1000 Sportster	61 CI	HD-2076	KN-178
XLH1000 Sportster	61 CI	HD-2076	KN-178

1975 HARLEY DAVIDSON			
FLH Electra Glide	74 CI	HD-0200	KN-178
FX Super Glide	74 CI	HD-0200	
FXE Super Glide	74 CI	HD-0200	
KH	900		KN-178

Vehicle	Engine	Air Filter	Oil Filter
1975 HARLEY DAVIDSON			
XL	900		KN-178
XLCH1000 Sportster	61 CI	HD-2075	KN-178
XLH1000 Sportster	61 CI	HD-2075	KN-178
1974 HARLEY DAVIDSON			
Aermacchi 350 Sprint	350	HD-2492	
Baja 100	100	HD-0300	
FL 74ci models	74 CI	HD-0200	KN-178
FLH Electra Glide	74 CI	HD-0200	KN-178
FX Super Glide	74 CI	HD-0200	KN-178
KH	900		KN-178
Sportster models	61 CI	HD-0200	
SR100	100	HD-0300	
XL	900		KN-178
XLCH1000 Sportster	61 CI		KN-178
XLH1000 Sportster	61 CI		KN-178

1973 HARLEY DAVIDSON			
Aermacchi 350 Sprint	350	HD-2492	
Baja 100	100	HD-0300	
FL 74ci models	74 CI	HD-0200	KN-178
FLH Electra Glide	74 CI	HD-0200	KN-178
FX Super Glide	74 CI	HD-0200	KN-178
KH	900		KN-178
Sportster models	61 CI	HD-0200	
SR100	100	HD-0300	
XL	900		KN-178
XLCH1000 Sportster	61 CI		KN-178
XLH1000 Sportster	61 CI		KN-178

1972 HARLEY DAVIDSON			
Aermacchi 350 Sprint	350	HD-2492	
Baja 100	100	HD-0300	
FL 74ci models	74 CI	HD-0200	KN-178
FLH Electra Glide	74 CI	HD-0200	KN-178
FX Super Glide	74 CI	HD-0200	KN-178
KH	900		KN-178
Sportster models	61 CI	HD-0200	
SR100	100	HD-0300	
XL	900		KN-178
XLCH1000 Sportster	61 CI		KN-178
XLH1000 Sportster	61 CI		KN-178

1971 HARLEY DAVIDSON			
Aermacchi 350 Sprint	350	HD-2492	
Baja 100	100	HD-0300	
FL 74ci models	74 CI	HD-0200	KN-178
FLH Electra Glide	74 CI	HD-0200	KN-178
FX Super Glide	74 CI	HD-0200	KN-178
KH	900		KN-178
Sportster models	55 CI	HD-0200	
XL	900		KN-178
XLCH1000 Sportster	61 CI		KN-178
XLH900	900		KN-178

1970 HARLEY DAVIDSON			
Aermacchi 350 Sprint	350	HD-2492	
Baja 100	100	HD-0300	
FL 74ci models	74 CI	HD-0200	KN-178
FLH Electra Glide	74 CI	HD-0200	KN-178
FX 74ci models	74 CI	HD-0200	KN-178
KH	900		KN-178
Sportster models	55 CI	HD-0200	
SR100	100	HD-0300	
XL	900		KN-178

◆ Intake Available. See Pages 10-15 ^ Use KN-170 for Black * Change C to B for Black Applications updated daily at knfilters.com ®

American V-Twin - Air & Oil Filters



Vehicle	Engine	Air Filter	Oil Filter
1970 HARLEY DAVIDSON			
XLCH1000 Sportster	61 CI		KN-178
XLH900	900		KN-178
1969 HARLEY DAVIDSON			
74FL Electra Glide	74 CI	HD-0200	
Aermacchi 350 Sprint	350	HD-2492	
FL 74ci models	74 CI	HD-0200	KN-178
FLH 74ci models	74 CI	HD-0200	KN-178
FX 74ci models	74 CI	HD-0200	KN-178
KH	900		KN-178
Sportster models	55 CI	HD-0200	
XL	900		KN-178
XLCH1000 Sportster	61 CI		KN-178
XLH900	900		KN-178
1968 HARLEY DAVIDSON			
74FL Electra Glide	74 CI	HD-0200	
FL 74ci models	74 CI	HD-0200	KN-178
FLH 74ci models	74 CI	HD-0200	KN-178
FX 74ci models	74 CI	HD-0200	KN-178
KH	900		KN-178
Sportster models	55 CI	HD-0200	
XL	900		KN-178
XLCH1000 Sportster	61 CI		KN-178
XLH900	900		KN-178
1967 HARLEY DAVIDSON			
74FL Electra Glide	74 CI	HD-0200	
FL 74ci models	74 CI	HD-0200	KN-178
FLH 74ci models	74 CI	HD-0200	KN-178
FX 74ci models	74 CI	HD-0200	KN-178
KH	900		KN-178
Sportster models	55 CI	HD-0200	
XL	900		KN-178
XLCH1000 Sportster	61 CI		KN-178
XLH900	900		KN-178
1966 HARLEY DAVIDSON			
KH	900		KN-178
XL	900		KN-178
XLCH1000 Sportster	61 CI		KN-178
XLH900	900		KN-178
1965 HARLEY DAVIDSON			
KH	900		KN-178
XL	900		KN-178
XLCH1000 Sportster	61 CI		KN-178
XLH900	900		KN-178
1964 HARLEY DAVIDSON			
KH	900		KN-178
XL	900		KN-178
XLCH1000 Sportster	61 CI		KN-178
XLH900	900		KN-178
1963 HARLEY DAVIDSON			
KH	900		KN-178
XL	900		KN-178
XLCH1000 Sportster	61 CI		KN-178
XLH900	900		KN-178
1962 HARLEY DAVIDSON			
KH	900		KN-178
XL	900		KN-178
XLCH1000 Sportster	61 CI		KN-178
XLH900	900		KN-178

Vehicle	Engine	Air Filter	Oil Filter
1961 HARLEY DAVIDSON			
KH	900		KN-178
XL	900		KN-178
XLCH1000 Sportster	61 CI		KN-178
XLH900	900		KN-178
1960 HARLEY DAVIDSON			
KH	900		KN-178
XL	900		KN-178
XLCH1000 Sportster	61 CI		KN-178
XLH900	900		KN-178
1959 HARLEY DAVIDSON			
KH	900		KN-178
XL	900		KN-178
XLCH1000 Sportster	61 CI		KN-178
XLH900	900		KN-178
1958 HARLEY DAVIDSON			
KH	900		KN-178
XL	900		KN-178
XLCH1000 Sportster	61 CI		KN-178
XLH900	900		KN-178
1957 HARLEY DAVIDSON			
KH	900		KN-178
XL	900		KN-178
XLCH1000 Sportster	61 CI		KN-178
XLH900	900		KN-178
1956 HARLEY DAVIDSON			
74ci V-Twin - OHV	74 CI	E-2470	
KH	900		KN-178
XL	900		KN-178
XLCH1000 Sportster	61 CI		KN-178
XLH900	900		KN-178
1955 HARLEY DAVIDSON			
45ci V-Twin - Flat Head	45 CI	E-2470	
74ci V-Twin - OHV	74 CI	E-2470	
KH	900		KN-178
XL	900		KN-178
XLCH1000 Sportster	61 CI		KN-178
XLH900	900		KN-178
1954 HARLEY DAVIDSON			
45ci V-Twin - Flat Head	45 CI	E-2470	
KH	900		KN-178
XL	900		KN-178
XLCH1000 Sportster	61 CI		KN-178
XLH900	900		KN-178
1953 HARLEY DAVIDSON			
45ci V-Twin - Flat Head	45 CI	E-2470	
1952 HARLEY DAVIDSON			
45ci V-Twin - Flat Head	45 CI	E-2470	
1951 HARLEY DAVIDSON			
45ci V-Twin - Flat Head	45 CI	E-2470	
1950 HARLEY DAVIDSON			
45ci V-Twin - Flat Head	45 CI	E-2470	
1949 HARLEY DAVIDSON			
45ci V-Twin - Flat Head	45 CI	E-2470	
1948 HARLEY DAVIDSON			
45ci V-Twin - Flat Head	45 CI	E-2470	

♦ Intake Available. See Pages 10-15 ^ Use KN-170 for Black * Change C to B for Black Applications updated daily at knfilters.com ®



American V-Twin - Air & Oil Filters

Vehicle	Engine	Air Filter	Oil Filter
1947 HARLEY DAVIDSON			
45ci V-Twin - Flat Head	45 CI	E-2470	
1946 HARLEY DAVIDSON			
45ci V-Twin - Flat Head	45 CI	E-2470	
1945 HARLEY DAVIDSON			
45ci V-Twin - Flat Head	45 CI	E-2470	
1944 HARLEY DAVIDSON			
45ci V-Twin - Flat Head	45 CI	E-2470	
1943 HARLEY DAVIDSON			
45ci V-Twin - Flat Head	45 CI	E-2470	
1942 HARLEY DAVIDSON			
45ci V-Twin - Flat Head	45 CI	E-2470	
1941 HARLEY DAVIDSON			
45ci V-Twin - Flat Head	45 CI	E-2470	
2017 INDIAN			
Chief Classic	111 CI	PL-1814	
Chief Dark Horse	111 CI	PL-1814	
Chief Vintage	111 CI	PL-1814	
Chieftain	111 CI	PL-1814	
Chieftain Dark Horse	111 CI	PL-1814	
Roadmaster	111 CI	PL-1814	
Springfield	111 CI	PL-1814	
2016 INDIAN			
Chief Classic	111 CI	PL-1814	KN-175
Chief Dark Horse	111 CI	PL-1814	KN-175
Chief Vintage	111 CI	PL-1814	KN-175
Chieftain	111 CI	PL-1814	KN-175
Chieftain Dark Horse	111 CI	PL-1814	KN-175
Roadmaster	111 CI	PL-1814	KN-175
Scout	69 CI	PL-1115	
Scout Sixty	69 CI	PL-1115	
Springfield	111 CI	PL-1814	
2015 INDIAN			
Chief Classic	111 CI	PL-1814	KN-157
Chief Vintage	111 CI	PL-1814	KN-157
Chieftain	111 CI	PL-1814	KN-157
Roadmaster	111 CI	PL-1814	KN-157
Scout	69 CI	PL-1115	
2014 INDIAN			
Chief Classic	111 CI	PL-1814	
Chief Vintage	111 CI	PL-1814	
Chieftain	111 CI	PL-1814	
2013 INDIAN			
Chief Classic	105 CI	E-3290	
Chief Dark Horse	105 CI	E-3290	
Chief Vintage	105 CI	E-3290	
Chief Vintage FE	105 CI	E-3290	
Chief Vintage LE	105 CI	E-3290	
2012 INDIAN			
Chief Classic	105 CI	E-3290	
Chief Dark Horse	105 CI	E-3290	
Chief Vintage	105 CI	E-3290	
2011 INDIAN			
Chief Blackhawk	105 CI	E-3290	
Chief Blackhawk Dark	105 CI	E-3290	
Chief Classic	105 CI	E-3290	
Chief Dark Horse	105 CI	E-3290	

Vehicle	Engine	Air Filter	Oil Filter
2011 INDIAN			
Chief Roadmaster	105 CI	E-3290	
Chief Vintage	105 CI	E-3290	
2010 INDIAN			
Chief Bomber	105 CI	E-3290	
Chief Classic	105 CI	E-3290	
Chief Dark Horse	105 CI	E-3290	
Chief Roadmaster	105 CI	E-3290	
Chief Vintage	105 CI	E-3290	
2009 INDIAN			
Chief Deluxe	105 CI	E-3290	
Chief Roadmaster	105 CI	E-3290	
Chief Standard	105 CI	E-3290	
Chief Vintage	105 CI	E-3290	
2003 INDIAN			
Chief	1638	E-3981	
Scout - w/S&S teardrop backplate & Indian teardrop cvr	1436	E-3971	
Spirit - w/S&S teardrop backplate & Indian teardrop cvr	1436	E-3971	
2002 INDIAN			
Chief	1638	E-3981	
Scout - w/S&S teardrop backplate & Indian teardrop cvr	1436	E-3971	
Spirit - w/S&S teardrop backplate & Indian teardrop cvr	1436	E-3971	
2001 INDIAN			
Scout - w/S&S teardrop backplate & Indian teardrop cvr	1436	E-3971	
Spirit - w/S&S teardrop backplate & Indian teardrop cvr	1436	E-3971	
2000 INDIAN			
Chief - w/S&S teardrop backplate & Indian teardrop cvr	1436	E-3971	
1999 INDIAN			
Chief - w/S&S teardrop backplate & Indian teardrop cvr	1436	E-3971	
2016 VICTORY			
Cross Country	1731		KN-198
Cross Country 8-Ball	1731		KN-198
Cross Country Tour	1731		KN-198
Gunner	1731	PL-1608	KN-198
Hammer S	1731	PL-1608	KN-198
High-Ball	1731	PL-1608	KN-198
Magnum	1731		KN-198
Magnum X-1 Stealth Edition	1731		KN-198
Vegas	1731	PL-1608	KN-198
Vegas 8-Ball	1731	PL-1608	KN-198
Vision	1731		KN-198
2015 VICTORY			
Cross Country	1731		KN-198
Cross Country 8-Ball	1731		KN-198
Cross Country Tour	1731		KN-198
Gunner	1731	PL-1608	KN-198
Hammer 8-Ball	1731	PL-1608	KN-198
High-Ball	1731	PL-1608	KN-198
Judge	1731	PL-1608	KN-198
Magnum	1731		KN-198
Magnum X-1	1731		KN-198
Ness Magnum	1731		KN-198
Vegas 8-Ball	1731	PL-1608	KN-198

♦ Intake Available. See Pages 10-15 ^ Use KN-170 for Black * Change C to B for Black Applications updated daily at knfilters.com ®

Partial Listing: Complete Listing of Vehicles and Parts at KNFILTERS.COM or call 1-800-858-3333

American V-Twin - Air & Oil Filters



Vehicle	Engine	Air Filter	Oil Filter
2015 VICTORY			
Vision Tour	1731		KN-198
2014 VICTORY			
Boardwalk	1731	PL-1608	KN-198
Cross Country	1731		KN-198
Cross Country 8-Ball	1731		KN-198
Cross Country Tour	1731		KN-198
Cross Country Tour 15th Anniversary LE	1731		KN-198
Cross Roads 8-Ball	1731		KN-198
Cross Roads Classic	1731		KN-198
Hammer 8-Ball	1731	PL-1608	KN-198
High-Ball	1731	PL-1608	KN-198
Jackpot	1731	PL-1608	KN-198
Judge	1731	PL-1608	KN-198
Ness Cross Country	1731		KN-198
Vegas 8-Ball	1731	PL-1608	KN-198
Vision Tour	1731		KN-198
2013 VICTORY			
Arlen Ness Vision	1731		KN-198
Boardwalk	1731	PL-1608	KN-198
Cross Country	1731		KN-198
Cross Country Cory Ness	1731		KN-198
Cross Country Tour	1731		KN-198
Cross Country Zach Ness	1731		KN-198
Cross Roads Classic	1731		KN-198
Hammer 8-Ball	1731	PL-1608	KN-198
Hard-Ball	1731		KN-198
High-Ball	1731	PL-1608	KN-198
Judge	1731	PL-1608	KN-198
Vegas 8-Ball	1731	PL-1608	KN-198
Vegas Jackpot	1731	PL-1608	KN-198
Vision Tour	1731		KN-198
2012 VICTORY			
Arlen Ness Vision	1731		KN-198
Cross Country	1731		KN-198
Cross Country Cory Ness	1731		KN-198
Cross Country Tour	1731		KN-198
Cross Roads	1731		KN-198
Hammer 8-Ball	1731	PL-1608	KN-198
Hammer S	1731	PL-1608	KN-198
Hard-Ball	1731		KN-198
High-Ball	1731	PL-1608	KN-198
Kingpin	1731	PL-1608	KN-198
Vegas	1731	PL-1608	KN-198
Vegas 8-Ball	1731	PL-1608	KN-198
Vegas Jackpot	1731	PL-1608	KN-198
Vegas Zach Ness	1731	PL-1608	KN-198
Vision Tour	1731		KN-198
2011 VICTORY			
Cross Country	1731		KN-198
Cross Country Cory Ness	1731		KN-198
Cross Roads	1731		KN-198
Hammer	1731	PL-1608	KN-198
Hammer 8-Ball	1731	PL-1608	KN-198
Hammer S	1731	PL-1608	KN-198
High-Ball	1731	PL-1608	KN-198
Kingpin	1731	PL-1608	KN-198
Kingpin 8-Ball	1731	PL-1608	KN-198
Vegas	1731	PL-1608	KN-198
Vegas 8-Ball	1731	PL-1608	KN-198
Vegas Jackpot	1731	PL-1608	KN-198

Vehicle	Engine	Air Filter	Oil Filter
2011 VICTORY			
Vegas Zach Ness	1731	PL-1608	KN-198
Victory Vision Arlen Ness	1731		KN-198
Vision 8-Ball	1731		KN-198
Vision Tour	1731		KN-198
2010 VICTORY			
Arlen Ness Victory Vision	1731		KN-198
Cross Country	1731		KN-198
Cross Roads	1731		KN-198
Hammer	1731	PL-1608	KN-198
Hammer 8-Ball	1731	PL-1608	KN-198
Hammer S	1731	PL-1608	KN-198
Jackpot Cory Ness	1731	PL-1608	KN-198
Kingpin	1634	PL-1608	KN-198
Kingpin 8-Ball	1634	PL-1608	KN-198
Kingpin Low	1634	PL-1608	
Kingpin Tour	1634	PL-1608	
Vegas	1634	PL-1608	KN-198
Vegas 8-Ball	1634	PL-1608	KN-198
Vegas Jackpot	1731	PL-1608	KN-198
Vegas Low	1634	PL-1608	
Vision 8-Ball	1731		KN-198
Vision Tour	1731		KN-198
2009 VICTORY			
Arlen Ness Vision	1731		KN-198
Hammer	1731	PL-1608	KN-198
Hammer S	1731	PL-1608	KN-198
Jackpot Cory Ness	1731	PL-1608	KN-198
Kingpin	1634	PL-1608	KN-198
Kingpin 8-Ball	1634	PL-1608	KN-198
Kingpin Low	1634	PL-1608	KN-198
Kingpin Tour	1634	PL-1608	KN-198
Vegas	1634	PL-1608	KN-198
Vegas 8-Ball	1634	PL-1608	KN-198
Vegas Jackpot	1731	PL-1608	KN-198
Vegas Low	1634	PL-1608	KN-198
Victory Vision Arlen Ness	1731		KN-198
Vision Street	1731		KN-198
Vision Street Premium	1731		KN-198
Vision Tour	1731		KN-198
Vision Tour 10th Anniversary	1731		KN-198
2008 VICTORY			
Hammer	1634	PL-1608	KN-198
Hammer S	1634	PL-1608	KN-198
Jackpot Arlen Ness	1634	PL-1608	KN-198
Jackpot Cory Ness	1634	PL-1608	
Jackpot Ness Signature Series	1634		KN-198
Kingpin	1634	PL-1608	KN-198
Kingpin 8-Ball	1634	PL-1608	
Kingpin Tour	1634	PL-1608	
Vegas	1634	PL-1608	KN-198
Vegas 8-Ball	1634	PL-1608	KN-198
Vegas Jackpot	1634	PL-1608	KN-198
Vegas Low	1634	PL-1608	
Vision Street	1731		KN-198
Vision Tour	1731		KN-198
2007 VICTORY			
Hammer	1634	PL-1500	KN-198
Hammer S	1634	PL-1500	KN-198
Jackpot Ness Signature Series	1634	PL-1500	KN-198
Kingpin	1634	PL-1500	KN-198
Kingpin Tour	1634	PL-1500	

♦ Intake Available. See Pages 10-15 ^ Use KN-170 for Black * Change C to B for Black Applications updated daily at knfilters.com ®



American V-Twin - Air & Oil Filters

Vehicle	Engine	Air Filter	Oil Filter
2007 VICTORY			
Vegas	1634	PL-1500	KN-198
Vegas 8-Ball	1634	PL-1500	KN-198
Vegas Jackpot	1634	PL-1500	KN-198
2006 VICTORY			
Hammer	1634	PL-1500	KN-198
Jackpot Ness Signature Series	1634	PL-1500	KN-198
Kingpin	1634	PL-1500	KN-198
Touring Cruiser	1508	PL-1500	KN-198
Vegas	1634	PL-1500	KN-198
Vegas 8-Ball	1634	PL-1500	KN-198
Vegas Jackpot	1634	PL-1500	KN-198
2005 VICTORY			
Hammer	1634	PL-1500	KN-198
Kingpin	1507	PL-1500	KN-198
Kingpin Ness Signature Series	1507	PL-1500	KN-198
Touring Cruiser	1508	PL-1500	KN-198
Vegas	1507	PL-1500	KN-198
Vegas 8-Ball	1507	PL-1500	KN-198
Vegas Ness Signature Series	1507	PL-1500	KN-198
2004 VICTORY			
Kingpin	1507	PL-1500	KN-198
Touring Cruiser	1508	PL-1500	KN-198
Vegas	1507	PL-1500	KN-198
2003 VICTORY			
Classic Cruiser	1508	PL-1500	KN-198
Kingpin	1634		KN-198
Touring Cruiser	1508	PL-1500	KN-198
Vegas	1507	PL-1500	KN-198
2002 VICTORY			
Deluxe Cruiser	1508	PL-1500	KN-198
Deluxe Touring Cruiser	1508	PL-1500	KN-198
Standard Cruiser	1507	PL-1500	KN-198
Touring Cruiser	1508	PL-1500	KN-198
2001 VICTORY			
V92C	1508	PL-1500	KN-303
		PL-1500	KN-303C
V92C Deluxe	1507	PL-1500	KN-303
		PL-1500	KN-303C
V92SC	1507	PL-1500	KN-303
		PL-1500	KN-303C
2000 VICTORY			
V92C	1508	PL-1500	KN-303
		PL-1500	KN-303C
V92C Special Edition	1508	PL-1500	KN-303
		PL-1500	KN-303C
V92SC	1507	PL-1500	KN-303
		PL-1500	KN-303C
1999 VICTORY			
V92C	1508	PL-1598	KN-303
		PL-1598	KN-303C
1998 VICTORY			
V92C	1508	PL-1598	

Motorcycle - Application Listing



CC	Model	Year	Air Filter	Air Filter Precharger	Custom	Custom Precharger	Oil Filter	Comments
APRILIA								
50	Mojito Custom	03-05					KN-183	
124	RS4 125	11-12					KN-563	
124	RS4 125	15-16					KN-563	
125	Atlantic	02-11					KN-183	
125	Mojito	03-06					KN-183	
125	Mojito	08-10					KN-183	
150	Mojito	03-08					KN-183	
200	Atlantic	03-08					KN-183	
250	Atlantic	04-09					KN-183	
250	Atlantic i.e.	06-09					KN-183	
300	Atlantic	10-11					KN-183	
350	ETX350	85-90					KN-151	
350	ETX350 Tuareg Wind	88-90					KN-151	
449	RXV 450 Enduro	06-08	AL-4506				KN-563	
449	RXV 450 Enduro	09-12					KN-563	
449	SXV 450	06-10	AL-4506				KN-563	
450	MXV450	08-14					KN-575	
460	Atlantic 500	02-04					KN-184	
549	RXV 550 Enduro	06-08	AL-4506				KN-563	
549	RXV 550 Enduro	09-12					KN-563	
549	SXV 550	06-11	AL-4506				KN-563	
549	SXV 550	12					KN-563	
600	Tuareg 600	85-93					KN-151	
644	Moto 650	95-01	TB-6000				KN-151	
649	Pegaso 650 Trail	06	AL-6505				KN-145	
652	Pegaso 650	93-96					KN-151	
652	Pegaso 650	97-00	AL-6502				KN-151	
652	Pegaso 650 i.e.	01-04	AL-6502				KN-151	
660	Pegaso 650	07-08	AL-6505				KN-145	
660	Pegaso 650 Factory	07	AL-6505				KN-145	
660	Pegaso 650 Strada	05	AL-6505				KN-145	
660	Pegaso 650 Strada	06-09	AL-6505					
660	Pegaso 650 Trail	07-08	AL-6505				KN-145	
660	Pegaso 660	05-12					KN-145	
750	Shiver 750	08-15					KN-184	
750	SL750 Shiver ABS	08-14					KN-184	
839	Mana 850	08-15	MG-0001					
839	Mana 850 GT ABS	09-15	MG-0001					
998	ETV1000 Caponord	01-03	AL-1002				KN-152*	*OEM AP0256187
998	ETV1000 Caponord	01-03	AL-1002				KN-564*	*OEM AP0956745
998	ETV1000 Caponord	04-05	AL-1002				KN-152	
998	ETV1000 Caponord	06-07	AL-1002				KN-152*	*OEM AP0256187
998	ETV1000 Caponord	06-07	AL-1002				KN-564*	*OEM AP0956745
998	ETV1000 Caponord	08	AL-1002				KN-152	
998	RST1000 Futura	01	AL-1098				KN-152	
998	RST1000 Futura	02	AL-1098				KN-152*	*OEM AP0256187
998	RST1000 Futura	02	AL-1098				KN-564*	*OEM AP0956745
998	RST1000 Futura	03	AL-1098				KN-152	
998	RST1000 Futura	04	AL-1098				KN-152*	*OEM AP0256187
998	RST1000 Futura	04	AL-1098				KN-564*	*OEM AP0956745
998	RST1000 Futura	05					KN-152	
998	RSV 1000 R	05-09	AL-1004				KN-152*	*OEM AP0256187
998	RSV 1000 R	05-09	AL-1004				KN-564*	*OEM AP0956745
998	RSV 1000 R	10-13	AL-1004				KN-138*	*Chrome=KN-138C
998	RSV 1000 R Factory	05-09	AL-1004				KN-152*	*OEM AP0256187

2) Requires Two; 3) Requires Three; 4) Requires Four. The use of custom air filter requires removal of air box. Some custom filters and intakes are not legal for sale or use on any pollution controlled motor vehicle in California or states adopting California emission procedures. See knfilters.com for CARB status on each part for a specific vehicle.



Motorcycle - Application Listing

CC	Model	Year	Air Filter	Air Filter Precharger	Custom	Custom Precharger	Oil Filter	Comments
APRILIA								
998	RSV 1000 R Factory	05-09	AL-1004				KN-564*	*OEM AP0956745
998	RSV 1000 R Factory	10-13	AL-1004				KN-138*	*Chrome=KN-138C
998	RSV Mille	98-99	AL-1098				KN-152	
998	RSV Mille	00	AL-1098				KN-152*	*OEM AP0256187
998	RSV Mille	00	AL-1098				KN-564*	*OEM AP0956745
998	RSV Mille	01-02	AL-1001				KN-152*	*OEM AP0256187
998	RSV Mille	01-02	AL-1001				KN-564*	*OEM AP0956745
998	RSV Mille	03	AL-1001				KN-152	
998	RSV Mille	04	AL-1004				KN-152*	*OEM AP0256187
998	RSV Mille	04	AL-1004				KN-564*	*OEM AP0956745
998	RSV Mille R	00	AL-1001				KN-152*	*OEM AP0256187
998	RSV Mille R	00	AL-1001				KN-564*	*OEM AP0956745
998	RSV Mille R	01-02					KN-152*	*OEM AP0256187
998	RSV Mille R	01-02					KN-564*	*OEM AP0956745
998	RSV Mille R	04					KN-152*	*OEM AP0256187
998	RSV Mille R	04					KN-564*	*OEM AP0956745
998	RSV Mille R Haga	03					KN-152*	*OEM AP0256187
998	RSV Mille R Haga	03					KN-564*	*OEM AP0956745
998	RSV Mille R Nera	04					KN-152*	*OEM AP0256187
998	RSV Mille R Nera	04					KN-564*	*OEM AP0956745
998	RSV Mille SP	00					KN-152*	*OEM AP0256187
998	RSV Mille SP	00					KN-564*	*OEM AP0956745
998	RSV Mille SP	01	AL-1098				KN-152*	*OEM AP0256187
998	RSV Mille SP	01	AL-1098				KN-564*	*OEM AP0956745
998	RSV Tuono	04-05	AL-1001				KN-152*	*OEM AP0256187
998	RSV Tuono	04-05	AL-1001				KN-564*	*OEM AP0956745
998	SL1000 Falco	00	AL-1098				KN-152	
998	SL1000 Falco	01	AL-1098				KN-152*	*OEM AP0256187
998	SL1000 Falco	01	AL-1098				KN-564*	*OEM AP0956745
998	SL1000 Falco	02	AL-1098				KN-152	
998	SL1000 Falco	03	AL-1098				KN-152*	*OEM AP0256187
998	SL1000 Falco	03	AL-1098				KN-564*	*OEM AP0956745
998	SL1000 Falco	04	AL-1098				KN-152	
998	SL1000 Falco	05-08					KN-152	
998	Tuono 1000 R	06-10	AL-1004				KN-152*	*OEM AP0256187
998	Tuono 1000 R	06-10	AL-1004				KN-564*	*OEM AP0956745
998	Tuono 1000 R	11	AL-1004					
998	Tuono 1000 R Factory	06	AL-1004				KN-152*	*OEM AP0256187
998	Tuono 1000 R Factory	06	AL-1004				KN-564*	*OEM AP0956745
998	Tuono 1000 R Factory	08	AL-1004				KN-152*	*OEM AP0256187
998	Tuono 1000 R Factory	08	AL-1004				KN-564*	*OEM AP0956745
998	Tuono 1000 R Factory	09	AL-1004				KN-152	
998	Tuono Fighter	03	AL-1001				KN-152*	*OEM AP0256187
998	Tuono Fighter	03	AL-1001				KN-564*	*OEM AP0956745
1000	RSV4 Factory	09	AL-1010					
1000	RSV4 Factory	09	AL-1010R*					*Race Specific
1000	RSV4 Factory	10	AL-1010				KN-138*	*Chrome=KN-138C
1000	RSV4 Factory	10	AL-1010R*				KN-138**	*Race Specific/ **Chrome=KN-138C
1000	RSV4 Factory APRC ABS	13	AL-1010					
1000	RSV4 Factory APRC ABS	13	AL-1010R*					*Race Specific
1000	RSV4 Factory SE	11-12	AL-1010					
1000	RSV4 Factory SE	11-12	AL-1010R*					*Race Specific
1000	RSV4 R	10	AL-1010					
1000	RSV4 R	10	AL-1010R*					*Race Specific
1000	RSV4 R	11	AL-1010				KN-138*	*Chrome=KN-138C

2) Requires Two; 3) Requires Three; 4) Requires Four. The use of custom air filter requires removal of air box. Some custom filters and intakes are not legal for sale or use on any pollution controlled motor vehicle in California or states adopting California emission procedures. See knfilters.com for CARB status on each part for a specific vehicle.

Motorcycle - Application Listing



CC	Model	Year	Air Filter	Air Filter Precharger	Custom	Custom Precharger	Oil Filter	Comments
APRILIA								
1000	RSV4 R	11	AL-1010R*				KN-138**	*Race Specific/ **Chrome=KN-138C
1000	RSV4 R	12	AL-1010					
1000	RSV4 R	12	AL-1010R*					*Race Specific
1000	RSV4 R APRC ABS	13	AL-1010					
1000	RSV4 R APRC ABS	13	AL-1010R*					*Race Specific
1000	RSV4 RF	15-16					KN-138*	*Chrome=KN-138C
1000	RSV4 RF LE	16					KN-138*	*Chrome=KN-138C
1000	RSV4 RR	16					KN-138*	*Chrome=KN-138C
1000	Tuono V4 R	11-13	AL-1010				KN-138*	*Chrome=KN-138C
1000	Tuono V4 R	11-13	AL-1010R*				KN-138**	*Race Specific/ **Chrome=KN-138C
1000	Tuono V4 R APRC	12-13	AL-1010					
1000	Tuono V4 R APRC	12-13	AL-1010R*					*Race Specific
1000	Tuono V4 R APRC ABS	14	AL-1010					
1000	Tuono V4 R APRC ABS	14	AL-1010R*					*Race Specific
1000	Tuono V4 R APRC ABS	15	AL-1010				KN-138*	*Chrome=KN-138C
1000	Tuono V4 R APRC ABS	15	AL-1010R*				KN-138**	*Race Specific/ **Chrome=KN-138C
1077	Tuono 1000 R Factory	16	AL-1010					
1077	Tuono 1000 R Factory	16	AL-1010R*					*Race Specific
1077	Tuono V4 1100 Factory ABS	15-16	AL-1010				KN-138*	*Chrome=KN-138C
1077	Tuono V4 1100 Factory ABS	15-16	AL-1010R*				KN-138**	*Race Specific/ **Chrome=KN-138C
1077	Tuono V4 1100RR ABS	15-16	AL-1010				KN-138*	*Chrome=KN-138C
1077	Tuono V4 1100RR ABS	15-16	AL-1010R*				KN-138**	*Race Specific/ **Chrome=KN-138C
1197	Caponord 1200	14	AL-1111					
1197	Caponord 1200 ABS Rally	15-16	AL-1111					
1197	Caponord 1200 ABS Travel Pack	15-16	AL-1111					
1197	Dorsoduro 1200	11-13	AL-1111					
BMW								
450	G450X	09-12					KN-611	
450	R45	78-85	BM-0200				KN-161	
450	R45N	78-85	BM-0300				KN-161	
500	R50/5	69-73	BM-0200				KN-161	
500	R500	55-65	BM-0100*					*w/choke
500	R500	67-69	BM-0100*					*w/choke
600	R60	81-84					KN-161	
600	R60/2	69					KN-161	
600	R60/5	70-74	BM-0200				KN-161	
600	R60/6	73-76	BM-0200				KN-161	
600	R60/7	76-79	BM-0200				KN-161	
600	R60/7	80					KN-161	
600	R600	55-65	BM-0100*					*w/choke
600	R600	67-69	BM-0100*					*w/choke
647	C600 Sport	14-15	BM-6012				KN-164	
650	F650	99					KN-151	
650	F650 Enduro	99					KN-151	
650	F650 Funduro	93-00					KN-151	
650	F650 SE	99					KN-151	
650	F650GS	01-03	BM-6501				KN-151	
650	F650GS ABS	00-03	BM-6501				KN-151	
650	F650GS Dakar	01-03	BM-6501				KN-151	
650	F650GS Dakar ABS	02-03	BM-6501				KN-151	
650	F650ST	97-99					KN-151	
650	F650ST Strada	00					KN-151	

2) Requires Two; 3) Requires Three; 4) Requires Four. The use of custom air filter requires removal of air box. Some custom filters and intakes are not legal for sale or use on any pollution controlled motor vehicle in California or states adopting California emission procedures. See knfilters.com for CARB status on each part for a specific vehicle.



Motorcycle - Application Listing

CC	Model	Year	Air Filter	Air Filter Precharger	Custom	Custom Precharger	Oil Filter	Comments
BMW								
650	G650 Xchallenge	07-11	BM-6507				KN-151	
650	G650 Xcountry	07-10	BM-6507				KN-151	
650	G650 Xmoto	07-10	BM-6507				KN-151	
650	G650GS	09-15	BM-6501				KN-151	
650	G650GS	16	BM-6501					
650	G650GS Sertao	12-15	BM-6501				KN-151	
650	R65	78-95	BM-0300				KN-161	
650	R65LS	78-85	BM-0300				KN-161	
652	F650CS	01	BM-6507					
652	F650CS	02-05	BM-6507				KN-151	
652	F650CS	06					KN-151	
652	F650CS ABS	03-05	BM-6507				KN-151	
652	F650GS	04-07	BM-6501				KN-151	
652	F650GS	08-09	BM-8006				KN-160	
652	F650GS ABS	05	BM-6501				KN-151	
652	F650GS Dakar	04-07	BM-6501				KN-151	
652	F650GS Dakar ABS	04-05	BM-6501				KN-151	
740	K75	90-95	BM-2605				KN-163	
740	K75A	94	BM-2605				KN-163	
750	K75	88-89	BM-2605				KN-163	
750	K75	96-97	BM-2605				KN-163	
750	K75 ABS	94	BM-2605				KN-163	
750	K75 ABS Special Edition	94	BM-2605				KN-163	
750	K75 Special Edition	94	BM-2605				KN-163	
750	K75/3	95	BM-2605				KN-163	
750	K75/3 ABS	95	BM-2605				KN-163	
750	K75C	85-88	BM-2605				KN-163	
750	K75RT	90-97	BM-2605				KN-163	
750	K75RT ABS	91-95	BM-2605				KN-163	
750	K75S	86-97	BM-2605				KN-163	
750	K75S ABS	91-95	BM-2605				KN-163	
750	K75T	86-87	BM-2605				KN-163	
750	R75	78-84	BM-0200				KN-161	
750	R75/5	69-73	BM-0200				KN-161	
750	R75/6	73	BM-0200				KN-161	
750	R75/6	75-76	BM-0200				KN-161	
750	R75/7	76-77	BM-0200				KN-161	
798	F650GS	10-12	BM-8006				KN-160	
798	F700GS	13-16	BM-8006				KN-160	
798	F700GS	17	BM-8006					
798	F800GS	07-12	BM-8006				KN-160	
798	F800GS	13-14	BM-8006				KN-164	
798	F800GS	15-16	BM-8006				KN-160	
798	F800GS	17	BM-8006					
798	F800GS Adventure	14	BM-8006				KN-164	
798	F800GS Adventure	15-16	BM-8006				KN-160	
798	F800GS Adventure	17	BM-8006					
798	F800GT	13-16	BM-8006				KN-160	
798	F800R	09-10	BM-8006				KN-164	
798	F800R	11-15	BM-8006				KN-160	
798	F800R	16					KN-160	
798	F800S	06-09	BM-8006				KN-164	
798	F800S	10-11	BM-8006					
798	F800ST	06-09	BM-8006				KN-164	
798	F800ST	10-12	BM-8006					

2) Requires Two; 3) Requires Three; 4) Requires Four. The use of custom air filter requires removal of air box. Some custom filters and intakes are not legal for sale or use on any pollution controlled motor vehicle in California or states adopting California emission procedures. See knfilters.com for CARB status on each part for a specific vehicle.

Motorcycle - Application Listing



CC	Model	Year	Air Filter	Air Filter Precharger	Custom	Custom Precharger	Oil Filter	Comments
BMW								
800	R80	85-89	BM-0300				KN-161	
800	R80	95	BM-0300				KN-161	
800	R80/7	76-79	BM-0200					
800	R80/7	84	BM-0300				KN-161	
800	R80GS	80-95	BM-0300				KN-161	
800	R80R	93-95	BM-0300				KN-161	
800	R80RT	80-83	BM-0200					
800	R80RT	84	BM-0200				KN-161	
800	R80RT	85-95	BM-0300				KN-161	
800	R80ST	80-81	BM-0300					
800	R80ST	82-86	BM-0300				KN-161	
800	R80ST	87-90					KN-161	
806	R80	90-91	BM-0300				KN-161	
806	R80	93-94	BM-0300				KN-161	
806	R80R	92	BM-0300				KN-161	
832	R850R	95-03	BM-0400				KN-163	
832	R850R ABS	96	BM-0400				KN-163	
832	R850R Special Edition	97	BM-0400				KN-163	
850	R850C	99-00					KN-163	
850	R850C Avantgarde	01					KN-163	
850	R850C Boxer	01					KN-163	
850	R850C Classic	01					KN-163	
850	R850C Euro	00-01					KN-163	
850	R850GS Boxer	99					KN-163	
850	R850R	04-05					KN-163	
850	R850R	06	BM-0400				KN-163	
850	R850R Boxer	99					KN-163	
850	R850R Classic	02-04					KN-163	
850	R850RT	99					KN-163	
900	R90/6	73-76	BM-0200				KN-161	
900	R900RT	05	BM-1204				KN-164	
900	R90S	69-76	BM-0200				KN-161	
990	S1000RR	09	BM-1010				KN-164	
990	S1000RR	09	BM-1010R*				KN-164	*Race Specific
990	S1000RR	10-13	BM-1010				KN-160	
990	S1000RR	10-13	BM-1010R*				KN-160	*Race Specific
999	HP4	12	BM-1010					
999	HP4	12	BM-1010R*					*Race Specific
999	HP4	13-14	BM-1010				KN-160	
999	HP4	13-14	BM-1010R*				KN-160	*Race Specific
999	HP4	15					KN-160	
999	HP4 Competition	14	BM-1010				KN-160	
999	HP4 Competition	14	BM-1010R*				KN-160	*Race Specific
999	S1000R	14-16	BM-1010				KN-160	
999	S1000R	14-16	BM-1010R*				KN-160	*Race Specific
999	S1000R	17	BM-1010					
999	S1000R	17	BM-1010R*					*Race Specific
999	S1000RR	14-16	BM-1010				KN-160	
999	S1000RR	14-16	BM-1010R*				KN-160	*Race Specific
999	S1000RR	17	BM-1010					
999	S1000RR	17	BM-1010R*					*Race Specific
999	S1000XR	14	BM-1010					
999	S1000XR	14	BM-1010R*					*Race Specific
999	S1000XR	15-16	BM-1010				KN-160	
999	S1000XR	15-16	BM-1010R*				KN-160	*Race Specific

2) Requires Two; 3) Requires Three; 4) Requires Four. The use of custom air filter requires removal of air box. Some custom filters and intakes are not legal for sale or use on any pollution controlled motor vehicle in California or states adopting California emission procedures. See knfilters.com for CARB status on each part for a specific vehicle.



Motorcycle - Application Listing

CC	Model	Year	Air Filter	Air Filter Precharger	Custom	Custom Precharger	Oil Filter	Comments
BMW								
999	S1000XR	17	BM-1010					
999	S1000XR	17	BM-1010R*					*Race Specific
1000	K1	89-93	BM-2605				KN-163	
1000	K1	94					KN-163	
1000	K100	83-89	BM-2605				KN-163	
1000	K100	90					KN-163	
1000	K100LT	83-93	BM-2605				KN-163	
1000	K100LT	94					KN-163	
1000	K100LT ABS	89-92	BM-2605				KN-163	
1000	K100RS	83-88	BM-2605				KN-163	
1000	K100RS	90	BM-2605				KN-163	
1000	K100RS	93	BM-2605				KN-163	
1000	K100RS	94					KN-163	
1000	K100RS ABS	88-89	BM-2605				KN-163	
1000	K100RS FL	91-92	BM-2605				KN-163	
1000	K100RS FL ABS	91-92	BM-2605				KN-163	
1000	K100RT	83-89	BM-2605				KN-163	
1000	K100RT	90-94					KN-163	
1000	R100	79-84	BM-0200					
1000	R100/7	76-78	BM-0200					
1000	R100CS	73-75					KN-161*	*w/o oil cooler
1000	R100CS	76-84	BM-0300				KN-161*	*w/o oil cooler
1000	R100CS	85-90					KN-161*	*w/o oil cooler
1000	R100GS	87-94	BM-0300				KN-161*	*w/o oil cooler
1000	R100GS	95	BM-0300					
1000	R100GS Paris-Dakar	90-94	BM-0300				KN-161*	*w/o oil cooler
1000	R100GS Paris-Dakar	95	BM-0300					
1000	R100MYS	91-95	BM-0300					
1000	R100PD	87-95	BM-0300					
1000	R100R	87-90					KN-161*	*w/o oil cooler
1000	R100R	91-95	BM-0300				KN-161*	*w/o oil cooler
1000	R100R	96					KN-161*	*w/o oil cooler
1000	R100RS	76-84	BM-0300					
1000	R100RS	87-95	BM-0300				KN-161*	*w/o oil cooler
1000	R100RS	96					KN-161*	*w/o oil cooler
1000	R100RT	76-84	BM-0300					
1000	R100RT	85					KN-161*	*w/o oil cooler
1000	R100RT	87-96	BM-0300				KN-161*	*w/o oil cooler
1000	R100S	73-75					KN-161*	*w/o oil cooler
1000	R100S	76-80	BM-0300				KN-161*	*w/o oil cooler
1000	R100S	81-82					KN-161*	*w/o oil cooler
1000	R100S	83-84	BM-0300				KN-161*	*w/o oil cooler
1000	R100S	86-90					KN-161*	*w/o oil cooler
1000	R100T	78-79	BM-0200					
1000	R100T	80-84	BM-0300					
1000	R100T Sport	80	BM-0300					
1000	R100TR	82	BM-0300					
1100	K1100LT	93-99	BM-2605				KN-163	
1100	K1100LT ABS	92	BM-2605				KN-163	
1100	K1100LT ABS Special Edition	94	BM-2605				KN-163	
1100	K1100LT ABS Special Edition	97	BM-2605				KN-163	
1100	K1100LT High Line	97	BM-2605				KN-163	
1100	K1100RS	90-95	BM-2605				KN-163	
1100	K1100RS	96-97	BM-2605					
1100	K1100RS SE	96	BM-2605					

2) Requires Two; 3) Requires Three; 4) Requires Four. The use of custom air filter requires removal of air box. Some custom filters and intakes are not legal for sale or use on any pollution controlled motor vehicle in California or states adopting California emission procedures. See knfilters.com for CARB status on each part for a specific vehicle.

Motorcycle - Application Listing



CC	Model	Year	Air Filter	Air Filter Precharger	Custom	Custom Precharger	Oil Filter	Comments
BMW								
1100	R1100GS	94-95	BM-0400				KN-163	
1100	R1100GS ABS	93	BM-0400				KN-163	
1100	R1100GS ABS	95-99	BM-0400				KN-163	
1100	R1100GS PD	98					KN-163	
1100	R1100GS SE	99	BM-0400				KN-163	
1100	R1100R	95-00	BM-0400				KN-163	
1100	R1100R ABS	95-98	BM-0400				KN-163	
1100	R1100R ABS	00	BM-0400				KN-163	
1100	R1100R SE	99	BM-0400				KN-163	
1100	R1100RA/S ABS	95	BM-0400				KN-163	
1100	R1100RL	01	BM-0400				KN-163	
1100	R1100RS	93-94	BM-0400				KN-163	
1100	R1100RS ABS	94-01	BM-0400				KN-163	
1100	R1100RS ABS Special Edition	94-95	BM-0400				KN-163	
1100	R1100RS Special Edition	00	BM-0400				KN-163	
1100	R1100RSL	94-96	BM-0400					
1100	R1100RSL ABS	97	BM-0400					
1100	R1100RSL ABS Special Edition	94-95	BM-0400					
1100	R1100RT	94-95	BM-0400				KN-163	
1100	R1100RT	96-98	BM-0400					
1100	R1100RT	99-01	BM-0400				KN-163	
1100	R1100RT SE	00	BM-0400				KN-163	
1100	R1100RTL	96-97	BM-0400					
1100	R1100S	98	BM-0400				KN-163	
1100	R1100S	99-05	BM-1199				KN-163	
1100	R1100S ABS	99	BM-1199				KN-163	
1100	R1100S ABS	02	BM-1199				KN-163	
1100	R1100S ABS	04-05	BM-1199				KN-163	
1100	R1100S Boxer Cup	02	BM-1199				KN-163	
1100	R1100S Boxer Cup Replica	03-05	BM-1199				KN-163	
1100	R1100S Prep	04					KN-163	
1100	R1100SA	00-01	BM-1199				KN-163	
1100	R1100SA SE	00	BM-1199				KN-163	
1150	R1150GS	99-03	BM-0400				KN-163	
1150	R1150GS	04-05					KN-163	
1150	R1150GS Adventure	02-05	BM-0400				KN-163	
1150	R1150GS Sport	03	BM-0400				KN-163	
1150	R1150R	01-06	BM-0400				KN-163	
1150	R1150R Rockster	04-06	BM-0400				KN-163	
1150	R1150R Rockster Edition 80	04	BM-0400				KN-163	
1150	R1150RS	01-05	BM-0400				KN-163	
1150	R1150RS SE	02					KN-163	
1150	R1150RT	01-05	BM-0400				KN-163	
1157	K1200GT	02-04	BM-1299					
1157	K1200GT	05	BM-1299				KN-160	
1157	K1200GT	06-08	BM-1205				KN-160	
1157	K1200R Sport	07	BM-1205				KN-160	
1157	K1200S	05-08	BM-1205 ²				KN-160	
1170	HP2 Enduro	05-08	BM-1204				KN-164	
1170	HP2 Megamoto	07-08	BM-1204				KN-164	
1170	HP2 Megamoto	10-11	BM-1204				KN-164	
1170	HP2 Sport	08-11	BM-1208				KN-164	
1170	K1200LT	04-08	BM-1299				KN-163	
1170	K1200LT	09	BM-1299					
1170	R nineT	14-15	BM-1204				KN-164	

2) Requires Two; 3) Requires Three; 4) Requires Four. The use of custom air filter requires removal of air box. Some custom filters and intakes are not legal for sale or use on any pollution controlled motor vehicle in California or states adopting California emission procedures. See knfilters.com for CARB status on each part for a specific vehicle.



Motorcycle - Application Listing

CC	Model	Year	Air Filter	Air Filter Precharger	Custom	Custom Precharger	Oil Filter	Comments
BMW								
1170	R nineT	16	BM-1204					
1170	R nineT Scrambler	16	BM-1204					
1170	R1200C	98-02	BM-1298				KN-163	
1170	R1200C Classic	97-00	BM-1298				KN-163	
1170	R1200C Cruiser	98	BM-1298					
1170	R1200C Cruiser	99-01	BM-1298				KN-163	
1170	R1200C Euro	98-02	BM-1298				KN-163	
1170	R1200C Independent	00	BM-1298				KN-163	
1170	R1200C Montana	00-03	BM-1298				KN-163	
1170	R1200C Phoenix	00	BM-1298				KN-163	
1170	R1200C Phoenix	02	BM-1298				KN-163	
1170	R1200C Stiletto	01	BM-1298				KN-163	
1170	R1200CL	02	BM-1298				KN-163	
1170	R1200GS	04-09	BM-1204				KN-164	
1170	R1200GS	13	BM-1113*				KN-160	*Water Cooled Eng.
1170	R1200GS	13	BM-1204*				KN-160	*Air Cooled Eng.
1170	R1200GS Adventure	05-09	BM-1204				KN-164	
1170	R1200GS HP2	05-08	BM-1204				KN-164	
1170	R1200R	07-09	BM-1204				KN-164	
1170	R1200R	15	BM-1113*				KN-160	*Liquid Cooled Eng.
1170	R1200R	16					KN-160	
1170	R1200RS	15	BM-1113*				KN-160	*Liquid Cooled Eng.
1170	R1200RS	15	BM-1204*				KN-160	*Air Cooled Eng.
1170	R1200RS	16	BM-1113				KN-160	
1170	R1200RT	05-09	BM-1204				KN-164	
1170	R1200S	06-07	BM-1204				KN-164	
1170	R1200S	09	BM-1204				KN-164	
1170	R1200ST	05-07	BM-1204				KN-164	
1171	K1200R	08	BM-1205				KN-160	
1171	K1200R Sport	08	BM-1205				KN-160	
1200	K1200C	99					KN-163	
1200	K1200C	02	BM-1299					
1200	K1200LT	98-03	BM-1299				KN-163	
1200	K1200LT ABS	02	BM-1299				KN-163	
1200	K1200LT Exodus	03	BM-1299				KN-163	
1200	K1200LT Lux	02	BM-1299				KN-163	
1200	K1200LT SE	02	BM-1299				KN-163	
1200	K1200LT SE	05	BM-1299				KN-163	
1200	K1200LTC	99-02	BM-1299				KN-163	
1200	K1200LTI Icon	99-01	BM-1299				KN-163	
1200	K1200LTS	99-00	BM-1299				KN-163	
1200	K1200R	05-07	BM-1205				KN-160	
1200	K1200RS	97-04	BM-1299				KN-163	
1200	K1200RS	05	BM-1299				KN-160	
1200	K1200RS Dakar	99	BM-1299				KN-163	
1200	K1200RS SE	02-04					KN-163	
1200	K1200RS SE	05					KN-160	
1200	R1200 HP2 Sport	08-10	BM-1208				KN-164	
1200	R1200C	04	BM-1298				KN-163	
1200	R1200C Avantgarde	00					KN-163	
1200	R1200C Avantgarde	01-02	BM-1298				KN-163	
1200	R1200C Avantgarde	03					KN-163	
1200	R1200C Classic	01-03	BM-1298				KN-163	
1200	R1200C Classic	04-05					KN-163	
1200	R1200C Independent	01-03	BM-1298				KN-163	

2) Requires Two; 3) Requires Three; 4) Requires Four. The use of custom air filter requires removal of air box. Some custom filters and intakes are not legal for sale or use on any pollution controlled motor vehicle in California or states adopting California emission procedures. See knfilters.com for CARB status on each part for a specific vehicle.

Motorcycle - Application Listing



CC	Model	Year	Air Filter	Air Filter Precharger	Custom	Custom Precharger	Oil Filter	Comments
BMW								
1200	R1200C Independent	04					KN-163	
1200	R1200C Montauk	03-04	BM-1298				KN-163	
1200	R1200C Montauk	05					KN-163	
1200	R1200C Phoenix	01	BM-1298				KN-163	
1200	R1200C Phoenix	04					KN-163	
1200	R1200CL	03-06	BM-1298				KN-163	
1200	R1200GS	10-12	BM-1204				KN-164	
1200	R1200GS	14-16	BM-1113				KN-160	
1200	R1200GS	17	BM-1113					
1200	R1200GS Adventure	10-12	BM-1204				KN-164	
1200	R1200GS Adventure	13	BM-1204				KN-160	
1200	R1200GS Adventure	14-16	BM-1113				KN-160	
1200	R1200GS Adventure	17	BM-1113					
1200	R1200R	10-12	BM-1204				KN-164	
1200	R1200R	13-14	BM-1204				KN-160	
1200	R1200R	15	BM-1204*				KN-160	*Air Cooled Eng.
1200	R1200R Classic	11	BM-1204				KN-164	
1200	R1200RT	10-13	BM-1204				KN-164	
1200	R1200RT	14-16	BM-1113				KN-160	
1200	R1200RT	17	BM-1113					
1200	R1200S	10-11	BM-1204				KN-164	
1300	K1300GT	09-11	BM-1205				KN-160	
1300	K1300GT SE	10	BM-1205				KN-160	
1300	K1300R	09-15	BM-1205				KN-160	
1300	K1300S	09-16	BM-1205 ²				KN-160	
1300	K1300S 30 Jahre K-Modelle	13	BM-1205 ²				KN-160	
1600	K1600GT	11-13	BM-1611					
1600	K1600GT	14-15	BM-1611				KN-164	
1600	K1600GT	16	BM-1611				KN-160	
1600	K1600GT	17	BM-1611					
1600	K1600GT Sport	14	BM-1611				KN-164	
1600	K1600GTL	11-13	BM-1611					
1600	K1600GTL	14-15	BM-1611				KN-164	
1600	K1600GTL	16	BM-1611				KN-160	
1600	K1600GTL	17	BM-1611					
1600	K1600GTL Exclusive	14-15	BM-1611				KN-164	
1600	K1600GTL Exclusive	16	BM-1611				KN-160	
BUELL								
480	Blast	00-08	BU-5000				KN-177	
500	Blast	09	BU-5000				KN-177	
500	Blast	10	BU-5000					
900	Lightning CityX XB9SX	05-07	BU-9003				KN-177	
900	Lightning CityX XB9SX	08					KN-177	
900	Lightning CityX XB9SX	09-10	BU-9003				KN-177	
900	Lightning XB9S	03-04	BU-9003				KN-177	
900	Lightning XB9SX	08	BU-9003				KN-177	
961	Firebolt XB9R	03-07	BU-9003				KN-177	
1125	1125CR	09-10	BU-1108				KN-564	
1125	1125R	08	BU-1108					
1125	1125R	09-10	BU-1108				KN-564	
1131	Firebolt XB9R	02	BU-9003				KN-177	
1168	Firebolt XB12R	04-10	BU-9003				KN-177	
1168	M2 Cyclone	97-02	BU-1297				KN-171C*	*Black=KN-171B
1168	M2 Cyclone Low	02	BU-1297				KN-171C*	*Black=KN-171B
1168	S1 Lightning	94-95					KN-171C*	*Black=KN-171B

2) Requires Two; 3) Requires Three; 4) Requires Four. The use of custom air filter requires removal of air box. Some custom filters and intakes are not legal for sale or use on any pollution controlled motor vehicle in California or states adopting California emission procedures. See knfilters.com for CARB status on each part for a specific vehicle.



Motorcycle - Application Listing

CC	Model	Year	Air Filter	Air Filter Precharger	Custom	Custom Precharger	Oil Filter	Comments
BUELL								
1168	S1 Lightning	96-99	BU-1297				KN-171C*	*Black=KN-171B
1168	S2 Thunderbolt	94-96					KN-171C*	*Black=KN-171B
1168	S2T Thunderbolt	94-96					KN-171C*	*Black=KN-171B
1168	S3 Thunderbolt	96					KN-171C*	*Black=KN-171B
1168	S3 Thunderbolt	97-99	BU-1297				KN-171C*	*Black=KN-171B
1168	S3 Thunderbolt	00-02	BU-1297				KN-177	
1168	S3T Thunderbolt	96					KN-171C*	*Black=KN-171B
1168	S3T Thunderbolt	97-99	BU-1297				KN-171C*	*Black=KN-171B
1168	S3T Thunderbolt	00-02	BU-1297				KN-177	
1168	Ulysses XB12X	06-09	BU-9003				KN-177	
1168	Ulysses XB12XT	08-09	BU-9003				KN-177	
1200	Lightning City XB12SX	10					KN-177	
1200	Lightning Long XB12SS	06-10	BU-9003				KN-177	
1200	Lightning XB12S	04-08	BU-9003				KN-177	
1200	Lightning XB12SCG	05-10	BU-9003				KN-177	
1200	Lightning XB12STT	07-08	BU-9003				KN-177	
1200	S1 Lightning	00-02	BU-1297				KN-177	
1200	S1 White Lightning	98	BU-1297				KN-171C*	*Black=KN-171B
1200	S2 Thunderbolt	97					KN-171C*	*Black=KN-171B
1200	S2 Thunderbolt	98-99	BU-1297				KN-171C*	*Black=KN-171B
1200	S2 Thunderbolt	00-02	BU-1297				KN-177	
1200	S2T Thunderbolt	97-98					KN-171C*	*Black=KN-171B
1200	S2T Thunderbolt	99	BU-1297				KN-171C*	*Black=KN-171B
1200	S2T Thunderbolt	00-02	BU-1297				KN-177	
1200	S3 Thunderbolt	94-95					KN-171C*	*Black=KN-171B
1200	S3T Thunderbolt	94-95					KN-171C*	*Black=KN-171B
1200	Ulysses Police XB12XP	09-10	BU-9003				KN-177	
1200	Ulysses XB12X	10	BU-9003				KN-177	
1200	Ulysses XB12XT	10	BU-9003				KN-177	
1200	X1 Lightning	99-02	BU-1297				KN-171C*	*Black=KN-171B
1200	X1W White Lightning	02	BU-1297				KN-171C*	*Black=KN-171B
CAN-AM								
125	125 MX-6	80	CM-0300					
125	MX4	78	CM-0200					
125	Qualifier	78	CM-0200					
125	Qualifier IV	82	CM-0300					
175	Qualifier	78	CM-0200					
175	Qualifier II	79	CM-0300					
175	Qualifier III	80	CM-0300					
175	Qualifier IV	82	CM-0300					
250	250 MX-6	80	CM-0300					
250	MX4	78	CM-0200					
250	MX5	79	CM-0300					
250	MX6B	81	CM-0300					
250	Qualifier	78	CM-0200					
250	Qualifier II	79-80	CM-0300					
250	Qualifier III	80	CM-0300					
250	Qualifier IV	82	CM-0300					
350	Qualifier III	80	CM-0300					
370	MX4	78	CM-0200					
370	MX5	79	CM-0300					
370	Qualifier	78	CM-0200					
400	400 MX-6	80	CM-0300					
400	MX6B	81	CM-0300					
400	Qualifier III	80	CM-0300					

2) Requires Two; 3) Requires Three; 4) Requires Four. The use of custom air filter requires removal of air box. Some custom filters and intakes are not legal for sale or use on any pollution controlled motor vehicle in California or states adopting California emission procedures. See knfilters.com for CARB status on each part for a specific vehicle.

Motorcycle - Application Listing



CC	Model	Year	Air Filter	Air Filter Precharger	Custom	Custom Precharger	Oil Filter	Comments
CAN-AM								
400	Qualifier IV	82	CM-0300					
450	Qualifier II	79	CM-0300					
500	Qualifier IV	82	CM-0300					
990	Spyder GS - SE5	08	CM-9908				KN-559*	*Transmission Filter
990	Spyder GS - SE5	08	CM-9908				KN-564	
990	Spyder GS - SM5	08	CM-9908				KN-559*	*Transmission Filter
990	Spyder GS - SM5	08	CM-9908				KN-564	
998	Spyder GS - SM5	09	CM-9908				KN-559*	*Transmission Filter
998	Spyder GS - SM5	09	CM-9908				KN-564	
998	Spyder RS	14-15	CM-9910					
998	Spyder RS SE5	09-11	CM-9908				KN-559*	*Transmission Filter
998	Spyder RS SE5	09-11	CM-9908				KN-564	
998	Spyder RS SE5	12					KN-559*	*Transmission Filter
998	Spyder RS SE5	12					KN-564	
998	Spyder RS SE5	13-14	CM-9910					
998	Spyder RS SM5	09-12	CM-9908				KN-559*	*Transmission Filter
998	Spyder RS SM5	09-12	CM-9908				KN-564	
998	Spyder RS SM5	13-16	CM-9910					
998	Spyder RS-S SE5	10-12	CM-9908				KN-559*	*Transmission Filter
998	Spyder RS-S SE5	10-12	CM-9908				KN-564	
998	Spyder RS-S SE5	13-16	CM-9910					
998	Spyder RS-S SM5	11-12	CM-9908				KN-559*	*Transmission Filter
998	Spyder RS-S SM5	11-12	CM-9908				KN-564	
998	Spyder RS-S SM5	13-16	CM-9910					
998	Spyder RT Limited SE5	10-12	CM-9910				KN-559*	*Transmission Filter
998	Spyder RT Limited SE5	10-13	CM-9910				KN-564	
998	Spyder RT SE5	10-11	CM-9910				KN-559*	*Transmission Filter
998	Spyder RT SE5	10-11	CM-9910				KN-564	
998	Spyder RT SE5	13	CM-9910				KN-564	
998	Spyder RT SE5 A/C	10-12	CM-9910				KN-559*	*Transmission Filter
998	Spyder RT SE5 A/C	10-12	CM-9910				KN-564	
998	Spyder RT SM5	10-12	CM-9910				KN-559*	*Transmission Filter
998	Spyder RT SM5	10-13	CM-9910				KN-564	
998	Spyder RT SM5 A/C	10-12	CM-9910				KN-559*	*Transmission Filter
998	Spyder RT SM5 A/C	10-12	CM-9910				KN-564	
998	Spyder RT-S SE5	12	CM-9910				KN-559*	*Transmission Filter
998	Spyder RT-S SE5	12-13	CM-9910				KN-564	
998	Spyder RT-S SM5	12	CM-9910				KN-559*	*Transmission Filter
998	Spyder RT-S SM5	12-13	CM-9910				KN-564	
998	Spyder ST	14-16	CM-9910					
998	Spyder ST Limited SE5	13-15	CM-9910					
998	Spyder ST SE5	13-14	CM-9910					
998	Spyder ST SM5	13-15	CM-9910					
998	Spyder ST-S SE5	13-15	CM-9910					
998	Spyder ST-S SM5	13-15	CM-9910					
1330	Spyder F3 Limited SE6	16	CM-1314					
1330	Spyder F3 Limited Special Series SE6	16	CM-1314					
1330	Spyder F3 SE6	15-16	CM-1314					
1330	Spyder F3 SM6	15-16	CM-1314					
1330	Spyder F3-S Daytona SE6	17	CM-1314					
1330	Spyder F3-S Daytona SM6	17	CM-1314					
1330	Spyder F3-S Limited Special Series SE6	16	CM-1314					
1330	Spyder F3-S SE6	15-17	CM-1314					
1330	Spyder F3-S SM6	15-17	CM-1314					
1330	Spyder F3-T SE6	16-17	CM-1314					

2) Requires Two; 3) Requires Three; 4) Requires Four. The use of custom air filter requires removal of air box. Some custom filters and intakes are not legal for sale or use on any pollution controlled motor vehicle in California or states adopting California emission procedures. See knfilters.com for CARB status on each part for a specific vehicle.



Motorcycle - Application Listing

CC	Model	Year	Air Filter	Air Filter Precharger	Custom	Custom Precharger	Oil Filter	Comments
CAN-AM								
1330	Spyder F3-T SM6	16-17	CM-1314					
1330	Spyder RT Limited SE6	14-17	CM-1314					
1330	Spyder RT SE6	14-17	CM-1314					
1330	Spyder RT SM6	14-17	CM-1314					
1330	Spyder RT-S SE6	14-17	CM-1314					
1330	Spyder RT-S SM6	14-16	CM-1314					
1330	Spyder RT-S Special Series SE6	16	CM-1314					
1330	Spyder ST-S SE5	16	CM-1314					
DUCATI								
350	350 F3	ALL					KN-153	
350	350 Indiana	ALL					KN-153	
350	350 Pantah	ALL					KN-153	
399	Scrambler Sixty2	16	DU-8015				KN-153	
400	400	94					KN-153	
400	400SS Junior	92					KN-153	
400	400SS Junior Super Sport	93					KN-153	
400	Monster 400	01-02	DU-9098				KN-153	
400	Monster 400	05					KN-153	
400	Monster 400	06-08	DU-9001				KN-153	
400	Monster 400 Dark	02-03	DU-9098				KN-153	
400	Monster 400 Dark	04					KN-153	
400	Monster 400 Dark i.e.	05	DU-9001				KN-153	
400	Monster 400 i.e.	05	DU-9001				KN-153	
400	Monster 400 Metallic	01	DU-9098				KN-153	
400	Monster 400s	03	DU-9098				KN-153	
500	500 GTL Twin	77-79	DU-0100					
500	500 Pantah	81			RC-1822*	RC-1820DK		*Inc. 2 Filters
583	600SS	91-98	DU-0900				KN-153	
583	600SS	99	DU-0900					
600	600 Pantah	82			RC-1822*	RC-1820DK		*Inc. 2 Filters
600	600 SL Pantah Sports	81-85					KN-153	
600	M600 Monster	93-97	DU-0900				KN-153	
600	Monster 600	98-01	DU-0900				KN-153	
600	Monster 600 City	99	DU-0900				KN-153	
600	Monster 600 Dark	98-01	DU-0900				KN-153	
600	Monster 600 Dark City	99-00	DU-0900				KN-153	
600	Monster 600 Metallic	00-01	DU-0900				KN-153	
618	Monster 620	03-04	DU-9001				KN-153	
618	Monster 620 Capirex	04	DU-9001				KN-153	
618	Monster 620 Dark	03-04	DU-9001				KN-153	
618	Monster 620 Matrix	04	DU-9001				KN-153	
618	Multistrada 620	05	DU-1004				KN-153	
618	Multistrada 620 Dark	05	DU-1004				KN-153	
620	620 Sport	03	DU-9098				KN-153	
620	Monster 620	02	DU-9001				KN-153	
620	Monster 620	05-06	DU-9001				KN-153	
620	Monster 620 Dark	05-06	DU-9001				KN-153	
620	Monster 620 Dark i.e.	04-05					KN-153	
620	Monster 620 Dark MD	01	DU-9001				KN-153	
620	Monster 620 Dark MD	04-05	DU-9001				KN-153	
620	Monster 620 i.e.	03-05					KN-153	
620	Monster 620s	02-03	DU-6202				KN-153	
620	Multistrada 620	06	DU-1004				KN-153	
620	Multistrada 620 Dark	06	DU-1004				KN-153	
650	650 Indiana Custom	86-88					KN-153	

2) Requires Two; 3) Requires Three; 4) Requires Four. The use of custom air filter requires removal of air box. Some custom filters and intakes are not legal for sale or use on any pollution controlled motor vehicle in California or states adopting California emission procedures. See knfilters.com for CARB status on each part for a specific vehicle.

Motorcycle - Application Listing



CC	Model	Year	Air Filter	Air Filter Precharger	Custom	Custom Precharger	Oil Filter	Comments
DUCATI								
659	Monster 659	11-12					KN-153*	*Australia
695	Monster 695	07	DU-9001				KN-153	
696	Monster 695	08	DU-9001				KN-153	
696	Monster 696	08-14	DU-6908				KN-153	
696	Monster 696 ABS	14	DU-6908				KN-153	
742	750SS	91-98	DU-0900				KN-153	
742	750SS	99	DU-9098				KN-153	
748	748	97-03					KN-153	
748	748 Biposto	95-99					KN-153	
748	748 SP	94-98					KN-153	
748	748 SPS	99					KN-153	
748	748R	00-02					KN-153	
748	748S	00-02					KN-153	
749	749	03-06					KN-153	
749	749 Dark	05-06					KN-153	
749	749R	04-06					KN-153	
749	749S	03-06					KN-153	
750	750 F1 MKII	85-87					KN-153	
750	750 GT	72-73			RC-1289*	22-8009PK		*Inc. 2 Filters
750	750 GT	72-73			RC-1289*	22-8048PK		*Inc. 2 Filters
750	750 Indiana Custom	87-88					KN-153	
750	750 Paso	86					KN-153	
750	750 Paso	87-88	DU-0900				KN-153	
750	750 Paso	89-90					KN-153	
750	750 Sport	72-73			RC-1289*	22-8009PK		*Inc. 2 Filters
750	750 Sport	72-73			RC-1289*	22-8048PK		*Inc. 2 Filters
750	750 Sport	88-90					KN-153	
750	750 Sport	01-02					KN-153	
750	750SS i.e.	00-02	DU-9098				KN-153	
750	M750 Monster	96	DU-9098				KN-153	
750	M750 Monster	97-98	DU-0900				KN-153	
750	Monster 750	99-01	DU-9098				KN-153	
750	Monster 750	02	DU-9001				KN-153	
750	Monster 750 City	99	DU-9098				KN-153	
750	Monster 750 Dark	99-01	DU-9098				KN-153	
750	Monster 750 Dark	02	DU-9001				KN-153	
750	Monster 750 Dark City	99	DU-9098				KN-153	
750	Monster 750 Metallic	00-01	DU-9098				KN-153	
750	Monster 750 Metallic	02	DU-9001				KN-153	
795	Monster 795	12					KN-153	
796	Hypermotard 796	10-13	DU-1006				KN-153	
796	Monster 796	10-13	DU-6908				KN-153	
800	800 Sport	03	DU-9098				KN-153	
800	800SS	03	DU-9098				KN-153	
800	800SS	06-07	DU-9098				KN-153	
800	Monster 800	04	DU-9001				KN-153	
800	Monster 800 Dark	03					KN-153	
800	Monster 800s	03	DU-9001				KN-153	
803	800SS	04-05	DU-9098				KN-153	
803	Monster 750	10-11					KN-153	
803	Monster 796	14	DU-1006				KN-153	
803	Monster 796 ABS	14	DU-1006				KN-153	
803	Monster S2R	05-07	DU-9001				KN-153	
803	Monster S2R 800	07	DU-9001				KN-153	
803	Monster S2R Dark	05-06	DU-9001				KN-153	

2) Requires Two; 3) Requires Three; 4) Requires Four. The use of custom air filter requires removal of air box. Some custom filters and intakes are not legal for sale or use on any pollution controlled motor vehicle in California or states adopting California emission procedures. See knfilters.com for CARB status on each part for a specific vehicle.



Motorcycle - Application Listing

CC	Model	Year	Air Filter	Air Filter Precharger	Custom	Custom Precharger	Oil Filter	Comments
DUCATI								
803	Scrambler Classic	15-16	DU-8015				KN-153	
803	Scrambler Flat Track Pro	16	DU-8015				KN-153	
803	Scrambler Full Throttle	15-16	DU-8015				KN-153	
803	Scrambler Icon	15-16	DU-8015				KN-153	
803	Scrambler Urban Enduro	15-16	DU-8015				KN-153	
821	Hypermotard	13-15	DU-1006				KN-153	
821	Hypermotard SP	13-15	DU-1006				KN-153	
821	Hyperstrada	13-15	DU-1006				KN-153	
821	Monster 821	15-16	DU-1006				KN-153	
821	Monster 821 Dark	15-16	DU-1006				KN-153	
821	Monster 821 Stripe	15-16	DU-1006				KN-153	
848	848	08-09	DU-1007				KN-153	
848	848	08-09	DU-1007R*				KN-153	*Race Specific
848	848 EVO	10-13	DU-1007				KN-153	
848	848 EVO	10-13	DU-1007R*				KN-153	*Race Specific
848	Streetfighter	12-15	DU-1007				KN-153	
848	Streetfighter	12-15	DU-1007R*				KN-153	*Race Specific
851	851 Strada	89-92					KN-153	
888	888 Strada	92-94					KN-153	
898	899 Panigale	13-14	DU-1112					
898	899 Panigale	13-14	DU-1112R*					*Race Specific
898	899 Panigale	15	DU-1112				KN-159	
898	899 Panigale	15	DU-1112R*				KN-159	*Race Specific
900	900 S2	79-85					KN-153	
900	900 Sport	02					KN-153	
900	900SS FE	98	DU-0900				KN-153	
900	900SS i.e.	00-01	DU-9098				KN-153	
900	900SS i.e.	02	DU-0900				KN-153	
900	Desmo	78	DU-0202					
900	MH900e	02					KN-153	
900	Monster 900 City	99	DU-9098				KN-153	
900	Monster 900 Cromo	99	DU-9098				KN-153	
900	Monster 900 Cromo	00-01	DU-0900				KN-153	
900	Monster 900 Dark	00	DU-9098				KN-153	
900	Monster 900 Dark	02	DU-9098				KN-153	
900	Monster 900s	99-00	DU-9098				KN-153	
904	900 SuperLight	91	DU-0900					
904	900 SuperLight	92-97	DU-0900				KN-153	
904	900SS	90					KN-153	
904	900SS	91-98	DU-0900				KN-153	
904	900SS	99	DU-9098				KN-153	
904	MH900e	01					KN-153	
904	Monster 900	93-98	DU-0900				KN-153	
904	Monster 900	99-02	DU-9098				KN-153	
904	Monster 900 Cromo	98	DU-0900				KN-153	
904	Monster 900 Dark	98	DU-0900				KN-153	
904	Monster 900 Dark	99	DU-9098				KN-153	
904	Monster 900 Dark	01	DU-9098				KN-153	
904	Monster 900 Dark City	99	DU-9098				KN-153	
904	Monster 900 i.e.	00	DU-9098				KN-153	
904	Monster 900 i.e.	02	DU-9098				KN-153	
904	Monster 900 Metallic	00-01	DU-9098				KN-153	
904	Monster 900s	98	DU-0900				KN-153	
904	Monster 900s	01	DU-9098				KN-153	
906	906 Paso	88-91					KN-153	

2) Requires Two; 3) Requires Three; 4) Requires Four. The use of custom air filter requires removal of air box. Some custom filters and intakes are not legal for sale or use on any pollution controlled motor vehicle in California or states adopting California emission procedures. See knfilters.com for CARB status on each part for a specific vehicle.

Motorcycle - Application Listing



CC	Model	Year	Air Filter	Air Filter Precharger	Custom	Custom Precharger	Oil Filter	Comments
DUCATI								
907	907 i.e.	90-93					KN-153	
916	916 Biposto	93-98					KN-153	
916	916 Monoposto	97-98					KN-153	
916	916 Senna	96-98					KN-153	
916	916 SP	93-96					KN-153	
916	916 SPS	93					KN-153	
916	916 SPS	97-98					KN-153	
916	916 SPS Fogarty	98-99					KN-153	
916	916 Strada	93-98					KN-153	
916	Monster S4	01-03	DU-9001				KN-153	
916	Monster S4 Fogarty	02	DU-9001				KN-153	
916	Monster S4R	03-04	DU-9001				KN-153	
916	ST4	99-00	DU-9098				KN-153	
944	ST2	97-03	DU-9098				KN-153	
959	959 Panigale	16	DU-1112				KN-159	
959	959 Panigale	16	DU-1112R*				KN-159	*Race Specific
968	Desmosedici RR	08					KN-153	
992	GT1000	07-10	DU-1006				KN-153	
992	GT1000 Touring	09-10	DU-1006				KN-153	
992	Monster S2R 1000	06-08	DU-9001				KN-153	
992	Paul Smart 1000 LE	06	DU-1006				KN-153	
992	Sport 1000	06	DU-1006				KN-153	
992	Sport 1000 Biposto	07-08	DU-1006				KN-153	
992	Sport 1000 Monoposto	07	DU-1006				KN-153	
992	Sport 1000S	07-10	DU-1006				KN-153	
992	ST3	04-07	DU-9098				KN-153	
992	ST3S ABS	06-07	DU-9098				KN-153	
992	ST4	01-03	DU-9098				KN-153	
992	ST4s	01-05	DU-9098				KN-153	
992	ST4S ABS	03-05	DU-9098				KN-153	
996	996	98					KN-153	
996	996 Biposto	99-01					KN-153	
996	996 Monoposto	99-01					KN-153	
996	996 SPS	99-00					KN-153	
996	996 SPS Fogarty	99					KN-153	
996	996R	01					KN-153	
996	996S	00-01					KN-153	
996	996S Monoposto	01					KN-153	
996	Monster S4R	05-06	DU-9001				KN-153	
996	Monster S4Rs	06	DU-9001				KN-153	
997	Monster S4R	07	DU-9001				KN-153	
997	Monster S4R Testastretta	07-08	DU-9001				KN-153	
997	Monster S4Rs Testastretta	06-08	DU-9001				KN-153	
998	998 Biposto	02-03					KN-153	
998	998 Matrix	04					KN-153	
998	998 Monoposto	02-03					KN-153	
998	998R	02					KN-153	
998	998S	02					KN-153	
998	998S Bayliss	02					KN-153	
998	998S Bostrom	02					KN-153	
998	998S Monoposto	02					KN-153	
998	Monster S4Rs Tricolore	08	DU-9001				KN-153	
999	999	03-06					KN-153	
999	999R	03-06					KN-153	
999	999R FILA	03-04					KN-153	

2) Requires Two; 3) Requires Three; 4) Requires Four. The use of custom air filter requires removal of air box. Some custom filters and intakes are not legal for sale or use on any pollution controlled motor vehicle in California or states adopting California emission procedures. See knfilters.com for CARB status on each part for a specific vehicle.



Motorcycle - Application Listing

CC	Model	Year	Air Filter	Air Filter Precharger	Custom	Custom Precharger	Oil Filter	Comments
DUCATI								
999	999R Xerox	06					KN-153	
999	999S	03-06					KN-153	
999	Multistrada 1000 DS	05-06	DU-1004				KN-153	
999	Multistrada 1000s DS	05-06	DU-1004				KN-153	
1000	1000SS	03-06	DU-9098				KN-153	
1000	Monster 1000	04-05	DU-9001				KN-153	
1000	Monster 1000 Dark	03	DU-9001				KN-153	
1000	Monster 1000s	03-05	DU-9001				KN-153	
1000	Multistrada 1000 DS	03-04	DU-1004				KN-153	
1078	Multistrada 1100	07-09	DU-1004				KN-153	
1078	Multistrada 1100s	07-09	DU-1004				KN-153	
1079	Hypermotard 1100	08-09	DU-1006				KN-153	
1079	Hypermotard 1100s	08-09	DU-1006				KN-153	
1098	1098	07-08	DU-1007				KN-153	
1098	1098	07-08	DU-1007R*				KN-153	*Race Specific
1098	1098s	07-08	DU-1007				KN-153	
1098	1098s	07-08	DU-1007R*				KN-153	*Race Specific
1098	1098s Tricolore	07	DU-1007				KN-153	
1098	1098s Tricolore	07	DU-1007R*				KN-153	*Race Specific
1099	Streetfighter	11	DU-1007				KN-153	
1099	Streetfighter	11	DU-1007R*				KN-153	*Race Specific
1099	Streetfighter S	11-13	DU-1007				KN-153	
1099	Streetfighter S	11-13	DU-1007R*				KN-153	*Race Specific
1100	Hypermotard 1100 EVO	10-13	DU-1006				KN-153	
1100	Hypermotard 1100 EVO SP	10-13	DU-1006				KN-153	
1100	Monster 1100	08					KN-153	
1100	Monster 1100	09-11	DU-6908				KN-153	
1100	Monster 1100 EVO	12-13	DU-6908				KN-153	
1100	Monster 1100s	08					KN-153	
1100	Monster 1100s	09-11	DU-6908				KN-153	
1100	Monster Diesel	12					KN-153	
1100	Monster Diesel	13	DU-6908				KN-153	
1100	Streetfighter	09-10	DU-1007				KN-153	
1100	Streetfighter	09-10	DU-1007R*				KN-153	*Race Specific
1100	Streetfighter S	09-10	DU-1007				KN-153	
1100	Streetfighter S	09-10	DU-1007R*				KN-153	*Race Specific
1198	1098R	08-09	DU-1007					
1198	1098R	08-09	DU-1007R*					*Race Specific
1198	1098R Bayliss LE	09	DU-1007					
1198	1098R Bayliss LE	09	DU-1007R*					*Race Specific
1198	1198	09-11	DU-1007				KN-153	
1198	1198	09-11	DU-1007R*				KN-153	*Race Specific
1198	1198 Panigale R	16	DU-1112				KN-159	
1198	1198 Panigale R	16	DU-1112R*				KN-159	*Race Specific
1198	1198R Corse	10-11	DU-1007				KN-153	
1198	1198R Corse	10-11	DU-1007R*				KN-153	*Race Specific
1198	1198S	09-11	DU-1007				KN-153	
1198	1198S	09-11	DU-1007R*				KN-153	*Race Specific
1198	1198S Corse	10	DU-1007				KN-153	
1198	1198S Corse	10	DU-1007R*				KN-153	*Race Specific
1198	1198SP	11	DU-1007				KN-153	
1198	1198SP	11	DU-1007R*				KN-153	*Race Specific
1198	1199 Panigale	12-14	DU-1112				KN-159	
1198	1199 Panigale	12-14	DU-1112R*				KN-159	*Race Specific
1198	1199 Panigale R	13-15	DU-1112				KN-159	

2) Requires Two; 3) Requires Three; 4) Requires Four. The use of custom air filter requires removal of air box. Some custom filters and intakes are not legal for sale or use on any pollution controlled motor vehicle in California or states adopting California emission procedures. See knfilters.com for CARB status on each part for a specific vehicle.

Motorcycle - Application Listing



CC	Model	Year	Air Filter	Air Filter Precharger	Custom	Custom Precharger	Oil Filter	Comments
DUCATI								
1198	1199 Panigale R	13-15	DU-1112R*				KN-159	*Race Specific
1198	1199 Panigale S	12-14	DU-1112				KN-159	
1198	1199 Panigale S	12-14	DU-1112R*				KN-159	*Race Specific
1198	1199 Panigale S Tricolore	12-13	DU-1112				KN-159	
1198	1199 Panigale S Tricolore	12-13	DU-1112R*				KN-159	*Race Specific
1198	Diavel	11-16	DU-1007				KN-153	
1198	Diavel	11-16	DU-1007R*				KN-153	*Race Specific
1198	Diavel AMG	12	DU-1007				KN-153	
1198	Diavel AMG	12	DU-1007R*				KN-153	*Race Specific
1198	Diavel Carbon	11-16	DU-1007				KN-153	
1198	Diavel Carbon	11-16	DU-1007R*				KN-153	*Race Specific
1198	Diavel Cromo	12	DU-1007				KN-153	
1198	Diavel Cromo	12	DU-1007R*				KN-153	*Race Specific
1198	Diavel Dark	13-14	DU-1007				KN-153	
1198	Diavel Dark	13-14	DU-1007R*				KN-153	*Race Specific
1198	Diavel Strada	13-14	DU-1007				KN-153	
1198	Diavel Strada	13-14	DU-1007R*				KN-153	*Race Specific
1198	Diavel Titanium	15	DU-1007				KN-153	
1198	Diavel Titanium	15	DU-1007R*				KN-153	*Race Specific
1198	Monster 1200	14-16	DU-1006				KN-153	
1198	Monster 1200 R	16	DU-1006				KN-153	
1198	Monster 1200s	14-16	DU-1006				KN-153	
1198	Monster 1200s Stripe	15	DU-1006				KN-153	
1198	Multistrada 1200	10	DU-1210				KN-153	
1198	Multistrada 1200	11	DU-1007*				KN-153	*Non-US, Exc. ABS
1198	Multistrada 1200	11	DU-1007R*				KN-153	*Non-US, Exc. ABS, Race Specific
1198	Multistrada 1200	11	DU-1210*				KN-153	*US
1198	Multistrada 1200	12-14	DU-1210				KN-153	
1198	Multistrada 1200	15-16	DU-1112				KN-153	
1198	Multistrada 1200	15-16	DU-1112R*				KN-153	*Race Specific
1198	Multistrada 1200 Enduro	16	DU-1112				KN-153	
1198	Multistrada 1200 Enduro	16	DU-1112R*				KN-153	*Race Specific
1198	Multistrada 1200 Pikes Peak	16	DU-1112				KN-153	
1198	Multistrada 1200 Pikes Peak	16	DU-1112R*				KN-153	*Race Specific
1198	Multistrada 1200s	11	DU-1210				KN-153	
1198	Multistrada 1200s	15-16	DU-1112				KN-153	
1198	Multistrada 1200s	15-16	DU-1112R*				KN-153	*Race Specific
1198	Multistrada 1200s Dair	15	DU-1112				KN-153	
1198	Multistrada 1200s Dair	15	DU-1112R*				KN-153	*Race Specific
1198	Multistrada 1200s Granturismo	13-14	DU-1210				KN-153	
1198	Multistrada 1200s Pikes Peak	12-14	DU-1210				KN-153	
1198	Multistrada 1200s Sport	10	DU-1210				KN-153	
1198	Multistrada 1200s Sport	12-14	DU-1210				KN-153	
1198	Multistrada 1200s Touring	10	DU-1210				KN-153	
1198	Multistrada 1200s Touring	12-14	DU-1210				KN-153	
1198	Panigale R	15					KN-159	
1200	Multistrada 1200s	10	DU-1210				KN-153	
1285	1200 Panigale	15					KN-159	
1285	1200 Panigale S	15					KN-159	
1285	1299 Panigale	15-16	DU-1112				KN-159	
1285	1299 Panigale	15-16	DU-1112R*				KN-159	*Race Specific
1285	1299 Panigale R	15-16	DU-1112				KN-159	
1285	1299 Panigale R	15-16	DU-1112R*				KN-159	*Race Specific
1285	1299 Panigale S	15-16	DU-1112				KN-159	
1285	1299 Panigale S	15-16	DU-1112R*				KN-159	*Race Specific

2) Requires Two; 3) Requires Three; 4) Requires Four. The use of custom air filter requires removal of air box. Some custom filters and intakes are not legal for sale or use on any pollution controlled motor vehicle in California or states adopting California emission procedures. See knfilters.com for CARB status on each part for a specific vehicle.



Motorcycle - Application Listing

CC	Model	Year	Air Filter	Air Filter Precharger	Custom	Custom Precharger	Oil Filter	Comments
DUCATI								
1285	1299 Panigale S Anniversario	16	DU-1112				KN-159	
1285	1299 Panigale S Anniversario	16	DU-1112R*				KN-159	*Race Specific
HARLEY DAVIDSON								
100	Baja 100	70-74	HD-0300					
100	SR100	70	HD-0300					
100	SR100	72-74	HD-0300					
350	Aermacchi 350 Sprint	69-74	HD-2492					
900	KH	54-78					KN-178	
900	XL	54-78					KN-178	
900	XLH900	54-71					KN-178	
30 CI	XG500 Street	14					KN-204*	*Chrome=KN-204C
30 CI	XG500 Street	15-16	HD-4915		63-1130		KN-204*	*Chrome=KN-204C
30 CI	XG500 Street	17	HD-4915					
45 CI	45ci V-Twin	41-55	E-2470*					*Flat Head
46 CI	XG750 Street	14					KN-204*	*Chrome=KN-204C
46 CI	XG750 Street	15-16	HD-4915		63-1130		KN-204*	*Chrome=KN-204C
46 CI	XG750 Street	17	HD-4915					
54 CI	XL53C Sportster Custom	99					KN-170C	
54 CI	XL53C Sportster Custom	00	HD-1388				KN-170C	
54 CI	XL53C Sportster Custom	01-03					KN-170C	
54 CI	XL883 Sportster	04	HD-8834		RK-3944	HD-0800DK	KN-170C	
54 CI	XL883 Sportster	04	HD-8834		RK-3944B	HD-0800DK	KN-170C	
54 CI	XL883 Sportster	04-08	HD-8834		RK-3929		KN-170C	
54 CI	XL883 Sportster	06-08	HD-8834		RK-3944	HD-0800DK	KN-170C	
54 CI	XL883 Sportster	06-08	HD-8834		RK-3944B	HD-0800DK	KN-170C	
54 CI	XL883 Sportster	07-08	HD-8834		63-1126	RC-3680DK	KN-170C	
54 CI	XL883 Sportster	07-08	HD-8834		63-1126P	RC-3680DK	KN-170C	
54 CI	XL883C Sportster Custom	02-03	HD-1388				KN-170C	
54 CI	XL883C Sportster Custom	04-09	HD-8834		RK-3944	HD-0800DK	KN-170C	
54 CI	XL883C Sportster Custom	04-09	HD-8834		RK-3944B	HD-0800DK	KN-170C	
54 CI	XL883C Sportster Custom	04-10	HD-8834		RK-3929		KN-170C	
54 CI	XL883C Sportster Custom	08-10	HD-8834		63-1126	RC-3680DK	KN-170C	
54 CI	XL883C Sportster Custom	08-10	HD-8834		63-1126P	RC-3680DK	KN-170C	
54 CI	XL883L Sportster Low	04					KN-170C	
54 CI	XL883L Sportster Low	05-10	HD-8834		RK-3929		KN-170C	
54 CI	XL883L Sportster Low	05-10	HD-8834		RK-3944	HD-0800DK	KN-170C	
54 CI	XL883L Sportster Low	05-10	HD-8834		RK-3944B	HD-0800DK	KN-170C	
54 CI	XL883L Sportster Low	08-10	HD-8834		63-1126	RC-3680DK	KN-170C	
54 CI	XL883L Sportster Low	08-10	HD-8834		63-1126P	RC-3680DK	KN-170C	
54 CI	XL883L SuperLow	11-13	HD-8834		63-1126	RC-3680DK	KN-170C	
54 CI	XL883L SuperLow	11-13	HD-8834		63-1126P	RC-3680DK	KN-170C	
54 CI	XL883L SuperLow	11-13	HD-8834		RK-3929		KN-170C	
54 CI	XL883L SuperLow	11-13	HD-8834		RK-3944	HD-0800DK	KN-170C	
54 CI	XL883L SuperLow	11-13	HD-8834		RK-3944B	HD-0800DK	KN-170C	
54 CI	XL883L SuperLow	14	HD-1212		63-1126	RC-3680DK	KN-170C	
54 CI	XL883L SuperLow	14	HD-1212		63-1126P	RC-3680DK	KN-170C	
54 CI	XL883L SuperLow	14	HD-1212		RK-3929		KN-170C	
54 CI	XL883L SuperLow	14	HD-1212		RK-3944	HD-0800DK	KN-170C	
54 CI	XL883L SuperLow	14	HD-1212		RK-3944B	HD-0800DK	KN-170C	
54 CI	XL883L SuperLow	15	HD-1212		RK-3943		KN-171C*	*Black=KN-171B
54 CI	XL883L SuperLow	15-16	HD-1212		63-1126	RC-3680DK	KN-171C*	*Black=KN-171B
54 CI	XL883L SuperLow	15-16	HD-1212		63-1126P	RC-3680DK	KN-171C*	*Black=KN-171B
54 CI	XL883L SuperLow	15-16	HD-1212		RK-3945	HD-0800DK	KN-171C*	*Black=KN-171B
54 CI	XL883L SuperLow	15-16	HD-1212		RK-3945B	HD-0800DK	KN-171C*	*Black=KN-171B
54 CI	XL883L SuperLow	17	HD-1212		63-1126	RC-3680DK		

2) Requires Two; 3) Requires Three; 4) Requires Four. The use of custom air filter requires removal of air box. Some custom filters and intakes are not legal for sale or use on any pollution controlled motor vehicle in California or states adopting California emission procedures. See knfilters.com for CARB status on each part for a specific vehicle.

Motorcycle - Application Listing



CC	Model	Year	Air Filter	Air Filter Precharger	Custom	Custom Precharger	Oil Filter	Comments
HARLEY DAVIDSON								
54 CI	XL883L SuperLow	17	HD-1212		63-1126P	RC-3680DK		
54 CI	XL883N Iron	09-13	HD-8834		63-1126	RC-3680DK	KN-170C	
54 CI	XL883N Iron	09-13	HD-8834		63-1126P	RC-3680DK	KN-170C	
54 CI	XL883N Iron	09-13	HD-8834		RK-3944	HD-0800DK	KN-170C	
54 CI	XL883N Iron	09-13	HD-8834		RK-3944B	HD-0800DK	KN-170C	
54 CI	XL883N Iron	10-13	HD-8834		RK-3929		KN-170C	
54 CI	XL883N Iron	14	HD-1212		63-1126	RC-3680DK	KN-170C	
54 CI	XL883N Iron	14	HD-1212		63-1126P	RC-3680DK	KN-170C	
54 CI	XL883N Iron	14	HD-1212		RK-3929		KN-170C	
54 CI	XL883N Iron	14	HD-1212		RK-3944	HD-0800DK	KN-170C	
54 CI	XL883N Iron	14	HD-1212		RK-3944B	HD-0800DK	KN-170C	
54 CI	XL883N Iron	15	HD-1212		RK-3943		KN-171C*	*Black=KN-171B
54 CI	XL883N Iron	15-16	HD-1212		63-1126	RC-3680DK	KN-171C*	*Black=KN-171B
54 CI	XL883N Iron	15-16	HD-1212		63-1126P	RC-3680DK	KN-171C*	*Black=KN-171B
54 CI	XL883N Iron	15-16	HD-1212		RK-3945	HD-0800DK	KN-171C*	*Black=KN-171B
54 CI	XL883N Iron	15-16	HD-1212		RK-3945B	HD-0800DK	KN-171C*	*Black=KN-171B
54 CI	XL883N Iron	17	HD-1212		63-1126	RC-3680DK		
54 CI	XL883N Iron	17	HD-1212		63-1126P	RC-3680DK		
54 CI	XL883R Sportster	02-03	HD-1388				KN-170C	
54 CI	XL883R Sportster	04					KN-170C	
54 CI	XL883R Sportster	05-07	HD-8834		RK-3929		KN-170C	
54 CI	XL883R Sportster	06-07	HD-8834		RK-3944	HD-0800DK	KN-170C	
54 CI	XL883R Sportster	06-07	HD-8834		RK-3944B	HD-0800DK	KN-170C	
54 CI	XL883R Sportster	07	HD-8834		63-1126	RC-3680DK	KN-170C	
54 CI	XL883R Sportster	07	HD-8834		63-1126P	RC-3680DK	KN-170C	
54 CI	XL883R Sportster Roadster	12	HD-8834				KN-170C	
54 CI	XLH883	80-84					KN-172B*	*Black
54 CI	XLH883	80-84					KN-172C*	*Chrome
54 CI	XLH883 Sportster	86-87	HD-2085				KN-170C	
54 CI	XLH883 Sportster	88-03	HD-1388				KN-170C	
54 CI	XLH883 Sportster	04-06					KN-170C	
54 CI	XLH883 Sportster Custom	99-03	HD-1388				KN-170C	
54 CI	XLH883 Sportster Custom	04-05					KN-170C	
54 CI	XLH883 Sportster Custom	06	HD-8834				KN-170C	
54 CI	XLH883 Sportster Deluxe	86-87	HD-2085				KN-170C	
54 CI	XLH883 Sportster Deluxe	88-95	HD-1388				KN-170C	
54 CI	XLH883 Sportster Hugger	88-03	HD-1388				KN-170C	
54 CI	XLH883 Sportster Hugger F/I	87	HD-2085				KN-170C	
54 CI	XLH883L Sportster Low	05-06					KN-170C	
54 CI	XLH883R Sportster Flat Track	00	HD-1388				KN-170C	
54 CI	XLH883R Sportster R	06					KN-170C	
55 CI	Sportster models	67-71	HD-0200					
61 CI	Sportster models	72-74	HD-0200					
61 CI	XL1000 Sportster	84-85					KN-170C*	*Black=KN-170
61 CI	XLCH1000 Sportster	54-74					KN-178	
61 CI	XLCH1000 Sportster	75	HD-2075				KN-178	
61 CI	XLCH1000 Sportster	76-78	HD-2076				KN-178	
61 CI	XLH Sportster Annv.	78	HD-2076				KN-178	
61 CI	XLH1000 Sportster	72-74					KN-178	
61 CI	XLH1000 Sportster	75	HD-2075				KN-178	
61 CI	XLH1000 Sportster	76-78	HD-2076				KN-178	
61 CI	XLH1000 Sportster	79-82	HD-2078				KN-178	
61 CI	XLH1000 Sportster	83-85	HD-2076					
61 CI	XLH1000 Sportster	86-88					KN-170C	
61 CI	XLHA Sportster Annv.	82	HD-2078					

2) Requires Two; 3) Requires Three; 4) Requires Four. The use of custom air filter requires removal of air box. Some custom filters and intakes are not legal for sale or use on any pollution controlled motor vehicle in California or states adopting California emission procedures. See knfilters.com for CARB status on each part for a specific vehicle.



Motorcycle - Application Listing

CC	Model	Year	Air Filter	Air Filter Precharger	Custom	Custom Precharger	Oil Filter	Comments
HARLEY DAVIDSON								
61 CI	XLS1000 Roadster	80-83					KN-172B*	*Black
61 CI	XLS1000 Roadster	80-83					KN-172C*	*Chrome
61 CI	XLS1000 Roadster	84					KN-172B*	*to early 1984 - Black
61 CI	XLS1000 Roadster	84					KN-172C*	*to early 1984 - Chrome
61 CI	XLS1000 Roadster	84-85					KN-170C*	*Black=KN-170
61 CI	XLX61 Sportster	84-85					KN-170C*	*Black=KN-170
61 CI	XR1000 Cafe Racer	83-85	RU-1370*					*Req Both Filters, w/o Vent
61 CI	XR1000 Cafe Racer	83-85	RU-1371*					*Req Both Filters, w/Vent
67 CI	XLH1100 Sportster	80-83					KN-172B*	*Black
67 CI	XLH1100 Sportster	80-83					KN-172C*	*Chrome
67 CI	XLH1100 Sportster	84					KN-172B*	*to early 1984 - Black
67 CI	XLH1100 Sportster	84					KN-172C*	*to early 1984 - Chrome
67 CI	XLH1100 Sportster	86-87	HD-2085				KN-170C	
67 CI	XLH1100 Sportster	88					KN-170C	
69 CI	VRSCA V-Rod	02-06	HD-1102				KN-174B*	*Black
69 CI	VRSCA V-Rod	02-06	HD-1102				KN-174C*	*Chrome
69 CI	VRSCAW V-Rod	07-09	HD-1102				KN-174B*	*Black
69 CI	VRSCAW V-Rod	07-09	HD-1102				KN-174C*	*Chrome
69 CI	VRSCAW V-Rod	10	HD-1102					
69 CI	VRSCB V-Rod	04-05	HD-1102				KN-174B*	*Black
69 CI	VRSCB V-Rod	04-05	HD-1102				KN-174C*	*Chrome
69 CI	VRSCD Night Rod	06-07	HD-1102				KN-174B*	*Black
69 CI	VRSCD Night Rod	06-07	HD-1102				KN-174C*	*Chrome
69 CI	VRSCDX Night Rod Special	07	HD-1102				KN-174B*	*Black
69 CI	VRSCDX Night Rod Special	07	HD-1102				KN-174C*	*Chrome
69 CI	VRSCR Street Rod	06-07	HD-1102				KN-174B*	*Black
69 CI	VRSCR Street Rod	06-07	HD-1102				KN-174C*	*Chrome
69 CI	VRSCX	07					KN-174B*	*Black
69 CI	VRSCX	07					KN-174C*	*Chrome
73 CI	XLH1200 Sportster	03	HD-1388				KN-170C	
74 CI	74ci V-Twin	55-56	E-2470*					*OHV
74 CI	74FL Electra Glide	67-69	HD-0200					
74 CI	FL 74ci models	67-74	HD-0200				KN-178	
74 CI	FLH 74ci models	67-69	HD-0200				KN-178	
74 CI	FLH Electra Glide	70-75	HD-0200				KN-178	
74 CI	FLH Electra Glide	76-78	HD-2075				KN-178	
74 CI	FLH Electra Glide	79-80	HD-2078				KN-178	
74 CI	FLH Electra Glide Classic	77	HD-2075					
74 CI	FLHS Sport Glide	77	HD-2075				KN-178	
74 CI	FX 74ci models	67-70	HD-0200				KN-178	
74 CI	FX Super Glide	71-74	HD-0200				KN-178	
74 CI	FX Super Glide	75	HD-0200					
74 CI	FX Super Glide	77-78	HD-2076					
74 CI	FX Super Glide	79	HD-2078					
74 CI	FXE Super Glide	75	HD-0200					
74 CI	FXE Super Glide	76-77	HD-2076					
74 CI	FXE Super Glide	78	HD-2076*					*Early Models
74 CI	FXE Super Glide	78	HD-2078*					*Late Models
74 CI	FXE Super Glide	79-80	HD-2078					
74 CI	FXEF Fat Bob	79	HD-2078					
74 CI	FXS Low Rider	76-78	HD-2076					
74 CI	FXS Low Rider	79	HD-2078					
74 CI	XL1200C Sportster Custom	96-97	HD-1388		RK-3903*	RK-3901PK	KN-170C	*Round Mirrored - Mirrored
74 CI	XL1200C Sportster Custom	96-97	HD-1388		RK-3904*	RK-3902PK	KN-170C	*Tear Mirrored - Mirrored
74 CI	XL1200C Sportster Custom	96-97	HD-1388		RK-3913*	RK-3901PK	KN-170C	*Round Grooved - Grooved

2) Requires Two; 3) Requires Three; 4) Requires Four. The use of custom air filter requires removal of air box. Some custom filters and intakes are not legal for sale or use on any pollution controlled motor vehicle in California or states adopting California emission procedures. See knfilters.com for CARB status on each part for a specific vehicle.

Motorcycle - Application Listing



CC	Model	Year	Air Filter	Air Filter Precharger	Custom	Custom Precharger	Oil Filter	Comments
HARLEY DAVIDSON								
74 CI	XL1200C Sportster Custom	96-97	HD-1388		RK-3914*	RK-3902PK	KN-170C	*Tear Grooved - Grooved
74 CI	XL1200C Sportster Custom	96-97	HD-1388		RK-3923*	RK-3901PK	KN-170C	*Round Flamed - Flamed
74 CI	XL1200C Sportster Custom	96-97	HD-1388		RK-3924*	RK-3902PK	KN-170C	*Tear Flamed - Flamed
74 CI	XL1200C Sportster Custom	98-03	HD-1388				KN-170C	
74 CI	XL1200C Sportster Custom	04-13	HD-8834		RK-3929		KN-170C	
74 CI	XL1200C Sportster Custom	04-13	HD-8834		RK-3944	HD-0800DK	KN-170C	
74 CI	XL1200C Sportster Custom	04-13	HD-8834		RK-3944B	HD-0800DK	KN-170C	
74 CI	XL1200C Sportster Custom	07-13	HD-8834		63-1126	RC-3680DK	KN-170C	
74 CI	XL1200C Sportster Custom	07-13	HD-8834		63-1126P	RC-3680DK	KN-170C	
74 CI	XL1200C Sportster Custom	14	HD-1212		63-1126	RC-3680DK	KN-170C	
74 CI	XL1200C Sportster Custom	14	HD-1212		63-1126P	RC-3680DK	KN-170C	
74 CI	XL1200C Sportster Custom	14	HD-1212		RK-3943		KN-170C	
74 CI	XL1200C Sportster Custom	14	HD-1212		RK-3945	HD-0800DK	KN-170C	
74 CI	XL1200C Sportster Custom	14	HD-1212		RK-3945B	HD-0800DK	KN-170C	
74 CI	XL1200C Sportster Custom	15	HD-1212		RK-3943		KN-171C*	*Black=KN-171B
74 CI	XL1200C Sportster Custom	15-16	HD-1212		RK-3945	HD-0800DK	KN-171C*	*Black=KN-171B
74 CI	XL1200C Sportster Custom	15-16	HD-1212		RK-3945B	HD-0800DK	KN-171C*	*Black=KN-171B
74 CI	XL1200C Sportster Custom	16	HD-1212		63-1126	RC-3680DK	KN-171C*	*Black=KN-171B
74 CI	XL1200C Sportster Custom	16	HD-1212		63-1126P	RC-3680DK	KN-171C*	*Black=KN-171B
74 CI	XL1200C Sportster Custom	17	HD-1212					
74 CI	XL1200L Sportster Low	06-11	HD-8834		RK-3929		KN-170C	
74 CI	XL1200L Sportster Low	07-11	HD-8834		63-1126	RC-3680DK	KN-170C	
74 CI	XL1200L Sportster Low	07-11	HD-8834		63-1126P	RC-3680DK	KN-170C	
74 CI	XL1200L Sportster Low	07-11	HD-8834		RK-3944	HD-0800DK	KN-170C	
74 CI	XL1200L Sportster Low	07-11	HD-8834		RK-3944B	HD-0800DK	KN-170C	
74 CI	XL1200N Sportster Nightster	07-12	HD-8834		63-1126	RC-3680DK	KN-170C	
74 CI	XL1200N Sportster Nightster	07-12	HD-8834		63-1126P	RC-3680DK	KN-170C	
74 CI	XL1200N Sportster Nightster	07-12	HD-8834		RK-3929		KN-170C	
74 CI	XL1200N Sportster Nightster	07-12	HD-8834		RK-3944	HD-0800DK	KN-170C	
74 CI	XL1200N Sportster Nightster	07-12	HD-8834		RK-3944B	HD-0800DK	KN-170C	
74 CI	XL1200R Sportster Roadster	04-08	HD-8834		RK-3929		KN-170C	
74 CI	XL1200R Sportster Roadster	04-08	HD-8834		RK-3944	HD-0800DK	KN-170C	
74 CI	XL1200R Sportster Roadster	04-08	HD-8834		RK-3944B	HD-0800DK	KN-170C	
74 CI	XL1200R Sportster Roadster	07-08	HD-8834		63-1126	RC-3680DK	KN-170C	
74 CI	XL1200R Sportster Roadster	07-08	HD-8834		63-1126P	RC-3680DK	KN-170C	
74 CI	XL1200S Sportster Sport	96-97	HD-1388		RK-3903*	RK-3901PK	KN-170C	*Round Mirrored - Mirrored
74 CI	XL1200S Sportster Sport	96-97	HD-1388		RK-3904*	RK-3902PK	KN-170C	*Tear Mirrored - Mirrored
74 CI	XL1200S Sportster Sport	96-97	HD-1388		RK-3913*	RK-3901PK	KN-170C	*Round Grooved - Grooved
74 CI	XL1200S Sportster Sport	96-97	HD-1388		RK-3914*	RK-3902PK	KN-170C	*Tear Grooved - Grooved
74 CI	XL1200S Sportster Sport	96-97	HD-1388		RK-3923*	RK-3901PK	KN-170C	*Round Flamed - Flamed
74 CI	XL1200S Sportster Sport	96-97	HD-1388		RK-3924*	RK-3902PK	KN-170C	*Tear Flamed - Flamed
74 CI	XL1200S Sportster Sport	98-03	HD-1388				KN-170C	
74 CI	XL1200T SuperLow	14	HD-1212		RK-3943			
74 CI	XL1200T SuperLow	14	HD-1212		RK-3945	HD-0800DK		
74 CI	XL1200T SuperLow	14	HD-1212		RK-3945B	HD-0800DK		
74 CI	XL1200T SuperLow	15	HD-1212		RK-3943		KN-171C*	*Black=KN-171B
74 CI	XL1200T SuperLow	15-16	HD-1212		RK-3945	HD-0800DK	KN-171C*	*Black=KN-171B
74 CI	XL1200T SuperLow	15-16	HD-1212		RK-3945B	HD-0800DK	KN-171C*	*Black=KN-171B
74 CI	XL1200T SuperLow	16	HD-1212		63-1126	RC-3680DK	KN-171C*	*Black=KN-171B
74 CI	XL1200T SuperLow	16	HD-1212		63-1126P	RC-3680DK	KN-171C*	*Black=KN-171B
74 CI	XL1200T SuperLow	17	HD-1212					
74 CI	XL1200V Seventy-Two	12	HD-1212		63-1126	RC-3680DK		
74 CI	XL1200V Seventy-Two	12	HD-1212		63-1126P	RC-3680DK		
74 CI	XL1200V Seventy-Two	12	HD-1212		RK-3944	HD-0800DK		
74 CI	XL1200V Seventy-Two	12	HD-1212		RK-3944B	HD-0800DK		

2) Requires Two; 3) Requires Three; 4) Requires Four. The use of custom air filter requires removal of air box. Some custom filters and intakes are not legal for sale or use on any pollution controlled motor vehicle in California or states adopting California emission procedures. See knfilters.com for CARB status on each part for a specific vehicle.



Motorcycle - Application Listing

CC	Model	Year	Air Filter	Air Filter Precharger	Custom	Custom Precharger	Oil Filter	Comments
HARLEY DAVIDSON								
74 CI	XL1200V Seventy-Two	13	HD-1212		RK-3944	HD-0800DK	KN-170C	
74 CI	XL1200V Seventy-Two	13	HD-1212		RK-3944B	HD-0800DK	KN-170C	
74 CI	XL1200V Seventy-Two	13-14	HD-1212		63-1126	RC-3680DK	KN-170C	
74 CI	XL1200V Seventy-Two	13-14	HD-1212		63-1126P	RC-3680DK	KN-170C	
74 CI	XL1200V Seventy-Two	14	HD-1212		RK-3943		KN-170C	
74 CI	XL1200V Seventy-Two	14	HD-1212		RK-3945	HD-0800DK	KN-170C	
74 CI	XL1200V Seventy-Two	14	HD-1212		RK-3945B	HD-0800DK	KN-170C	
74 CI	XL1200V Seventy-Two	15	HD-1212		RK-3943		KN-171C*	*Black=KN-171B
74 CI	XL1200V Seventy-Two	15-16	HD-1212		RK-3945	HD-0800DK	KN-171C*	*Black=KN-171B
74 CI	XL1200V Seventy-Two	15-16	HD-1212		RK-3945B	HD-0800DK	KN-171C*	*Black=KN-171B
74 CI	XL1200V Seventy-Two	16	HD-1212		63-1126	RC-3680DK	KN-171C*	*Black=KN-171B
74 CI	XL1200V Seventy-Two	16	HD-1212		63-1126P	RC-3680DK	KN-171C*	*Black=KN-171B
74 CI	XL1200X Forty-Eight	10-13	HD-8834		63-1126	RC-3680DK	KN-170C	
74 CI	XL1200X Forty-Eight	10-13	HD-8834		63-1126P	RC-3680DK	KN-170C	
74 CI	XL1200X Forty-Eight	10-13	HD-8834		RK-3929		KN-170C	
74 CI	XL1200X Forty-Eight	10-13	HD-8834		RK-3944	HD-0800DK	KN-170C	
74 CI	XL1200X Forty-Eight	10-13	HD-8834		RK-3944B	HD-0800DK	KN-170C	
74 CI	XL1200X Forty-Eight	14	HD-1212		63-1126	RC-3680DK	KN-170C	
74 CI	XL1200X Forty-Eight	14	HD-1212		63-1126P	RC-3680DK	KN-170C	
74 CI	XL1200X Forty-Eight	14	HD-1212		RK-3943		KN-170C	
74 CI	XL1200X Forty-Eight	14	HD-1212		RK-3945	HD-0800DK	KN-170C	
74 CI	XL1200X Forty-Eight	14	HD-1212		RK-3945B	HD-0800DK	KN-170C	
74 CI	XL1200X Forty-Eight	15	HD-1212		RK-3943		KN-171C*	*Black=KN-171B
74 CI	XL1200X Forty-Eight	15-16	HD-1212		RK-3945	HD-0800DK	KN-171C*	*Black=KN-171B
74 CI	XL1200X Forty-Eight	15-16	HD-1212		RK-3945B	HD-0800DK	KN-171C*	*Black=KN-171B
74 CI	XL1200X Forty-Eight	17	HD-1212					
74 CI	XL1200XC Sportster Roadster	16-17	HD-1212					
74 CI	XL50 50th Anniversary Sportster	07	HD-8834		63-1126	RC-3680DK	KN-170C	
74 CI	XL50 50th Anniversary Sportster	07	HD-8834		63-1126P	RC-3680DK	KN-170C	
74 CI	XL50 50th Anniversary Sportster	07	HD-8834		RK-3929		KN-170C	
74 CI	XLH Sportster Annv.	93	HD-1388				KN-170C	
74 CI	XLH1200 Sportster	80-83					KN-172B*	*Black
74 CI	XLH1200 Sportster	80-83					KN-172C*	*Chrome
74 CI	XLH1200 Sportster	84					KN-172B*	*to early 1984 - Black
74 CI	XLH1200 Sportster	84					KN-172C*	*to early 1984 - Chrome
74 CI	XLH1200 Sportster	88-90	HD-1388				KN-170C	
74 CI	XLH1200 Sportster	91-97	HD-1388		RK-3903*	RK-3901PK	KN-170C	*Round Mirrored - Mirrored
74 CI	XLH1200 Sportster	91-97	HD-1388		RK-3904*	RK-3902PK	KN-170C	*Tear Mirrored - Mirrored
74 CI	XLH1200 Sportster	91-97	HD-1388		RK-3913*	RK-3901PK	KN-170C	*Round Grooved - Grooved
74 CI	XLH1200 Sportster	91-97	HD-1388		RK-3914*	RK-3902PK	KN-170C	*Tear Grooved - Grooved
74 CI	XLH1200 Sportster	91-97	HD-1388		RK-3923*	RK-3901PK	KN-170C	*Round Flamed - Flamed
74 CI	XLH1200 Sportster	91-97	HD-1388		RK-3924*	RK-3902PK	KN-170C	*Tear Flamed - Flamed
74 CI	XLH1200 Sportster	98-02	HD-1388				KN-170C	
74 CI	XR1200	08-09	HD-1208				KN-170C	
74 CI	XR1200X Sportster	10-12	HD-1208				KN-170C	
76 CI	VRSCD Night Rod	08	HD-1102				KN-174B*	*Black
76 CI	VRSCD Night Rod	08	HD-1102				KN-174C*	*Chrome
76 CI	VRSCDX 10th Anniversary Edition	12	HD-1102					
76 CI	VRSCDX Night Rod Special	08-10	HD-1102				KN-174B*	*Black
76 CI	VRSCDX Night Rod Special	08-10	HD-1102				KN-174C*	*Chrome
76 CI	VRSCDX Night Rod Special	11-14	HD-1102					
76 CI	VRSCDX Night Rod Special	15	HD-1102				KN-174B*	*Black
76 CI	VRSCDX Night Rod Special	15	HD-1102				KN-174C*	*Chrome
76 CI	VRSCDX Night Rod Special	16-17	HD-1102					
76 CI	VRSCF V-Rod Muscle	09-10	HD-1102				KN-174B*	*Black

2) Requires Two; 3) Requires Three; 4) Requires Four. The use of custom air filter requires removal of air box. Some custom filters and intakes are not legal for sale or use on any pollution controlled motor vehicle in California or states adopting California emission procedures. See knfilters.com for CARB status on each part for a specific vehicle.

Motorcycle - Application Listing



CC	Model	Year	Air Filter	Air Filter Precharger	Custom	Custom Precharger	Oil Filter	Comments
HARLEY DAVIDSON								
76 CI	VRSCF V-Rod Muscle	09-10	HD-1102				KN-174C*	*Chrome
76 CI	VRSCF V-Rod Muscle	11-14	HD-1102					
76 CI	VRSCF V-Rod Muscle	15	HD-1102				KN-174B*	*Black
76 CI	VRSCF V-Rod Muscle	15	HD-1102				KN-174C*	*Chrome
76 CI	VRSCF V-Rod Muscle	16-17	HD-1102					
76 CI	VRSCSE Screamin Eagle V-Rod	05	HD-1102				KN-174B*	*Black
76 CI	VRSCSE Screamin Eagle V-Rod	05	HD-1102				KN-174C*	*Chrome
76 CI	VRSCSE2 Screamin Eagle V-Rod	06	HD-1102				KN-174B*	*Black
76 CI	VRSCSE2 Screamin Eagle V-Rod	06	HD-1102				KN-174C*	*Chrome
76 CI	VRSCX V-Rod	07	HD-1102				KN-174B*	*Black
76 CI	VRSCX V-Rod	07	HD-1102				KN-174C*	*Chrome
80 CI	FLT80 Tour Glide	81-83	HD-2078				KN-170C	
82 CI	FLH Electra Glide	81	HD-2078					
82 CI	FLH Electra Glide	82-83	HD-2078				KN-172B*	*Black
82 CI	FLH Electra Glide	82-83	HD-2078				KN-172C*	*Chrome
82 CI	FLH Electra Glide	84	HD-2084				KN-172B*	*Black
82 CI	FLH Electra Glide	84	HD-2084				KN-172C*	*Chrome
82 CI	FLH Electra Glide Classic	79-80	HD-2078					
82 CI	FLH Electra Glide Special	84	HD-2084					
82 CI	FLHC Electra Glide Classic	81	HD-2078					
82 CI	FLHC Electra Glide Classic	82	HD-2078				KN-172B*	*Black
82 CI	FLHC Electra Glide Classic	82	HD-2078				KN-172C*	*Chrome
82 CI	FLHF Sport Glide II	82	HD-2078					
82 CI	FLHR Road King	94			RK-3901*	RK-3901PK		*Round Mirrored
82 CI	FLHR Road King	94			RK-3902*	RK-3902PK		*Tear Mirrored - Mirrored
82 CI	FLHR Road King	94			RK-3911*	RK-3901PK		*Round Grooved - Grooved
82 CI	FLHR Road King	94			RK-3912*	RK-3902PK		*Tear Grooved - Grooved
82 CI	FLHR Road King	94			RK-3921*	RK-3901PK		*Round Flamed - Flamed
82 CI	FLHR Road King	94			RK-3922*	RK-3902PK		*Tear Flamed - Flamed
82 CI	FLHR Road King	95	HD-1390		RK-3901*	RK-3901PK		*Round Mirrored
82 CI	FLHR Road King	95	HD-1390		RK-3902*	RK-3902PK		*Tear Mirrored - Mirrored
82 CI	FLHR Road King	95	HD-1390		RK-3911*	RK-3901PK		*Round Grooved - Grooved
82 CI	FLHR Road King	95	HD-1390		RK-3912*	RK-3902PK		*Tear Grooved - Grooved
82 CI	FLHR Road King	95	HD-1390		RK-3921*	RK-3901PK		*Round Flamed - Flamed
82 CI	FLHR Road King	95	HD-1390		RK-3922*	RK-3902PK		*Tear Flamed - Flamed
82 CI	FLHR Road King	96-97	HD-1390		RK-3901*	RK-3901PK	KN-170C	*Round Mirrored
82 CI	FLHR Road King	96-97	HD-1390		RK-3902*	RK-3902PK	KN-170C	*Tear Mirrored - Mirrored
82 CI	FLHR Road King	96-97	HD-1390		RK-3911*	RK-3901PK	KN-170C	*Round Grooved - Grooved
82 CI	FLHR Road King	96-97	HD-1390		RK-3912*	RK-3902PK	KN-170C	*Tear Grooved - Grooved
82 CI	FLHR Road King	96-97	HD-1390		RK-3921*	RK-3901PK	KN-170C	*Round Flamed - Flamed
82 CI	FLHR Road King	96-97	HD-1390		RK-3922*	RK-3902PK	KN-170C	*Tear Flamed - Flamed
82 CI	FLHR Road King	98	HD-1390				KN-170C	
82 CI	FLHR Road King - Non-US	95-97	HD-1396					
82 CI	FLHRI Electra Glide Road King F/I	96	HD-1395				KN-171C*	*Black=KN-171B
82 CI	FLHRI Electra Glide Road King F/I	97-98	HD-1395					
82 CI	FLHS	84	HD-2084				KN-172B*	*Black
82 CI	FLHS	84	HD-2084				KN-172C*	*Chrome
82 CI	FLHS Electra Glide Sport	87-89	HD-2086				KN-170C	
82 CI	FLHS Electra Glide Sport	90-91	HD-1390				KN-170C	
82 CI	FLHS Electra Glide Sport	92-93	HD-1390		RK-3901*	RK-3901PK	KN-170C	*Round Mirrored
82 CI	FLHS Electra Glide Sport	92-93	HD-1390		RK-3902*	RK-3902PK	KN-170C	*Tear Mirrored - Mirrored
82 CI	FLHS Electra Glide Sport	92-93	HD-1390		RK-3911*	RK-3901PK	KN-170C	*Round Grooved - Grooved
82 CI	FLHS Electra Glide Sport	92-93	HD-1390		RK-3912*	RK-3902PK	KN-170C	*Tear Grooved - Grooved
82 CI	FLHS Electra Glide Sport	92-93	HD-1390		RK-3921*	RK-3901PK	KN-170C	*Round Flamed - Flamed
82 CI	FLHS Electra Glide Sport	92-93	HD-1390		RK-3922*	RK-3902PK	KN-170C	*Tear Flamed - Flamed

2) Requires Two; 3) Requires Three; 4) Requires Four. The use of custom air filter requires removal of air box. Some custom filters and intakes are not legal for sale or use on any pollution controlled motor vehicle in California or states adopting California emission procedures. See knfilters.com for CARB status on each part for a specific vehicle.



Motorcycle - Application Listing

CC	Model	Year	Air Filter	Air Filter Precharger	Custom	Custom Precharger	Oil Filter	Comments
HARLEY DAVIDSON								
82 CI	FLHS Electra Glide Sport	94					KN-170C	
82 CI	FLHS Sport Glide	82	HD-2078				KN-172B*	*Black
82 CI	FLHS Sport Glide	82	HD-2078				KN-172C*	*Chrome
82 CI	FLHS Super Glide	83	HD-2078				KN-172B*	*Black
82 CI	FLHS Super Glide	83	HD-2078				KN-172C*	*Chrome
82 CI	FLHT Electra Glide	83	HD-2078					
82 CI	FLHT Electra Glide	84					KN-170C*	*Black=KN-170
82 CI	FLHT Electra Glide	85					KN-170C	
82 CI	FLHT Electra Glide	86-87	HD-2086				KN-170C	
82 CI	FLHT Electra Glide	88-89					KN-170C	
82 CI	FLHT Electra Glide	96-99					KN-170C	
82 CI	FLHT Electra Glide	00-01					KN-171C*	*Black=KN-171B
82 CI	FLHT Electra Glide - Non-US	95-98	HD-1396					
82 CI	FLHT Electra Glide Standard	95-97	HD-1390		RK-3901*	RK-3901PK	KN-170C	*Round Mirrored
82 CI	FLHT Electra Glide Standard	95-97	HD-1390		RK-3902*	RK-3902PK	KN-170C	*Tear Mirrored - Mirrored
82 CI	FLHT Electra Glide Standard	95-97	HD-1390		RK-3911*	RK-3901PK	KN-170C	*Round Grooved - Grooved
82 CI	FLHT Electra Glide Standard	95-97	HD-1390		RK-3912*	RK-3902PK	KN-170C	*Tear Grooved - Grooved
82 CI	FLHT Electra Glide Standard	95-97	HD-1390		RK-3921*	RK-3901PK	KN-170C	*Round Flamed - Flamed
82 CI	FLHT Electra Glide Standard	95-97	HD-1390		RK-3922*	RK-3902PK	KN-170C	*Tear Flamed - Flamed
82 CI	FLHT Electra Glide Standard	98	HD-1390				KN-170C	
82 CI	FLHTC Chrome	88	HD-2086					
82 CI	FLHTC Chrome TT	87	HD-2086					
82 CI	FLHTC Classic Anniversary	93	HD-1390					
82 CI	FLHTC Electra Glide Classic	83	HD-2078					
82 CI	FLHTC Electra Glide Classic	84-85	HD-2084*				KN-170C	*Non-US
82 CI	FLHTC Electra Glide Classic	86-89	HD-2086				KN-170C	
82 CI	FLHTC Electra Glide Classic	90-91	HD-1390				KN-170C	
82 CI	FLHTC Electra Glide Classic	92-97	HD-1390		RK-3901*	RK-3901PK	KN-170C	*Round Mirrored
82 CI	FLHTC Electra Glide Classic	92-97	HD-1390		RK-3902*	RK-3902PK	KN-170C	*Tear Mirrored - Mirrored
82 CI	FLHTC Electra Glide Classic	92-97	HD-1390		RK-3911*	RK-3901PK	KN-170C	*Round Grooved - Grooved
82 CI	FLHTC Electra Glide Classic	92-97	HD-1390		RK-3912*	RK-3902PK	KN-170C	*Tear Grooved - Grooved
82 CI	FLHTC Electra Glide Classic	92-97	HD-1390		RK-3921*	RK-3901PK	KN-170C	*Round Flamed - Flamed
82 CI	FLHTC Electra Glide Classic	92-97	HD-1390		RK-3922*	RK-3902PK	KN-170C	*Tear Flamed - Flamed
82 CI	FLHTC Electra Glide Classic	98	HD-1390				KN-170C	
82 CI	FLHTC Electra Glide Classic - Non-US	95-98	HD-1396					
82 CI	FLHTC Liberty	86	HD-2086					
82 CI	FLHTCI Electra Glide Classic F/I	96-98	HD-1395				KN-170C	
82 CI	FLHTCI Ultra Classic Electra Glide Annv.	95	HD-1395					
82 CI	FLHTCU Electra Glide Ultra Classic	80-82					KN-170C	
82 CI	FLHTCU Electra Glide Ultra Classic	87-88					KN-170C	
82 CI	FLHTCU Electra Glide Ultra Classic	89	HD-2086				KN-170C	
82 CI	FLHTCU Electra Glide Ultra Classic	90-91	HD-1390				KN-170C	
82 CI	FLHTCU Electra Glide Ultra Classic	92-97	HD-1390		RK-3901*	RK-3901PK	KN-170C	*Round Mirrored
82 CI	FLHTCU Electra Glide Ultra Classic	92-97	HD-1390		RK-3902*	RK-3902PK	KN-170C	*Tear Mirrored - Mirrored
82 CI	FLHTCU Electra Glide Ultra Classic	92-97	HD-1390		RK-3911*	RK-3901PK	KN-170C	*Round Grooved - Grooved
82 CI	FLHTCU Electra Glide Ultra Classic	92-97	HD-1390		RK-3912*	RK-3902PK	KN-170C	*Tear Grooved - Grooved
82 CI	FLHTCU Electra Glide Ultra Classic	92-97	HD-1390		RK-3921*	RK-3901PK	KN-170C	*Round Flamed - Flamed
82 CI	FLHTCU Electra Glide Ultra Classic	92-97	HD-1390		RK-3922*	RK-3902PK	KN-170C	*Tear Flamed - Flamed
82 CI	FLHTCU Electra Glide Ultra Classic - Non-US	95-98	HD-1396					
82 CI	FLHTCU Electra Glide Ultra Classic Annv.	93	HD-1390		RK-3901*	RK-3901PK	KN-170C	*Round Mirrored
82 CI	FLHTCU Electra Glide Ultra Classic Annv.	93	HD-1390		RK-3902*	RK-3902PK	KN-170C	*Tear Mirrored - Mirrored
82 CI	FLHTCU Electra Glide Ultra Classic Annv.	93	HD-1390		RK-3911*	RK-3901PK	KN-170C	*Round Grooved - Grooved
82 CI	FLHTCU Electra Glide Ultra Classic Annv.	93	HD-1390		RK-3912*	RK-3902PK	KN-170C	*Tear Grooved - Grooved
82 CI	FLHTCU Electra Glide Ultra Classic Annv.	93	HD-1390		RK-3921*	RK-3901PK	KN-170C	*Round Flamed - Flamed
82 CI	FLHTCU Electra Glide Ultra Classic Annv.	93	HD-1390		RK-3922*	RK-3902PK	KN-170C	*Tear Flamed - Flamed

2) Requires Two; 3) Requires Three; 4) Requires Four. The use of custom air filter requires removal of air box. Some custom filters and intakes are not legal for sale or use on any pollution controlled motor vehicle in California or states adopting California emission procedures. See knfilters.com for CARB status on each part for a specific vehicle.

Motorcycle - Application Listing



CC	Model	Year	Air Filter	Air Filter Precharger	Custom	Custom Precharger	Oil Filter	Comments
HARLEY DAVIDSON								
82 CI	FLHTCUI Electra Glide Ultra Classic F/I	89-91					KN-170C	
82 CI	FLHTCUI Electra Glide Ultra Classic F/I	92			RK-3901*	RK-3901PK	KN-170C	*Round Mirrored
82 CI	FLHTCUI Electra Glide Ultra Classic F/I	92			RK-3902*	RK-3902PK	KN-170C	*Tear Mirrored - Mirrored
82 CI	FLHTCUI Electra Glide Ultra Classic F/I	92			RK-3911*	RK-3901PK	KN-170C	*Round Grooved - Grooved
82 CI	FLHTCUI Electra Glide Ultra Classic F/I	92			RK-3912*	RK-3902PK	KN-170C	*Tear Grooved - Grooved
82 CI	FLHTCUI Electra Glide Ultra Classic F/I	92			RK-3921*	RK-3901PK	KN-170C	*Round Flamed - Flamed
82 CI	FLHTCUI Electra Glide Ultra Classic F/I	92			RK-3922*	RK-3902PK	KN-170C	*Tear Flamed - Flamed
82 CI	FLHTCUI Electra Glide Ultra Classic F/I	93					KN-170C	
82 CI	FLHTCUI Electra Glide Ultra Classic F/I	94			RK-3901*	RK-3901PK	KN-170C	*Round Mirrored
82 CI	FLHTCUI Electra Glide Ultra Classic F/I	94			RK-3902*	RK-3902PK	KN-170C	*Tear Mirrored - Mirrored
82 CI	FLHTCUI Electra Glide Ultra Classic F/I	94			RK-3911*	RK-3901PK	KN-170C	*Round Grooved - Grooved
82 CI	FLHTCUI Electra Glide Ultra Classic F/I	94			RK-3912*	RK-3902PK	KN-170C	*Tear Grooved - Grooved
82 CI	FLHTCUI Electra Glide Ultra Classic F/I	94			RK-3921*	RK-3901PK	KN-170C	*Round Flamed - Flamed
82 CI	FLHTCUI Electra Glide Ultra Classic F/I	94			RK-3922*	RK-3902PK	KN-170C	*Tear Flamed - Flamed
82 CI	FLHTCUI Electra Glide Ultra Classic F/I	95					KN-170C	
82 CI	FLHTCUI Electra Glide Ultra Classic F/I	96	HD-1395		RK-3901*	RK-3901PK	KN-170C	*Round Mirrored
82 CI	FLHTCUI Electra Glide Ultra Classic F/I	96	HD-1395		RK-3902*	RK-3902PK	KN-170C	*Tear Mirrored - Mirrored
82 CI	FLHTCUI Electra Glide Ultra Classic F/I	96	HD-1395		RK-3911*	RK-3901PK	KN-170C	*Round Grooved - Grooved
82 CI	FLHTCUI Electra Glide Ultra Classic F/I	96	HD-1395		RK-3912*	RK-3902PK	KN-170C	*Tear Grooved - Grooved
82 CI	FLHTCUI Electra Glide Ultra Classic F/I	96	HD-1395		RK-3921*	RK-3901PK	KN-170C	*Round Flamed - Flamed
82 CI	FLHTCUI Electra Glide Ultra Classic F/I	96	HD-1395		RK-3922*	RK-3902PK	KN-170C	*Tear Flamed - Flamed
82 CI	FLHTCUI Electra Glide Ultra Classic F/I	97-98	HD-1395				KN-170C	
82 CI	FLHX Electra Glide Special	84	HD-2084					
82 CI	FLST Heritage Softail	86	HD-2086					
82 CI	FLST Heritage Softail	87-89	HD-2086				KN-170C	
82 CI	FLST Heritage Softail	90	HD-1390				KN-170C	
82 CI	FLSTC Heritage Softail Classic	80-87					KN-170C	
82 CI	FLSTC Heritage Softail Classic	88-89	HD-2086				KN-170C	
82 CI	FLSTC Heritage Softail Classic	90-91	HD-1390				KN-170C	
82 CI	FLSTC Heritage Softail Classic	92-97	HD-1390		RK-3901*	RK-3901PK	KN-170C	*Round Mirrored
82 CI	FLSTC Heritage Softail Classic	92-97	HD-1390		RK-3902*	RK-3902PK	KN-170C	*Tear Mirrored - Mirrored
82 CI	FLSTC Heritage Softail Classic	92-97	HD-1390		RK-3911*	RK-3901PK	KN-170C	*Round Grooved - Grooved
82 CI	FLSTC Heritage Softail Classic	92-97	HD-1390		RK-3912*	RK-3902PK	KN-170C	*Tear Grooved - Grooved
82 CI	FLSTC Heritage Softail Classic	92-97	HD-1390		RK-3921*	RK-3901PK	KN-170C	*Round Flamed - Flamed
82 CI	FLSTC Heritage Softail Classic	92-97	HD-1390		RK-3922*	RK-3902PK	KN-170C	*Tear Flamed - Flamed
82 CI	FLSTC Heritage Softail Classic	98-99	HD-1390				KN-170C	
82 CI	FLSTC Heritage Softail Classic - Non-US	95-99	HD-1396					
82 CI	FLSTF Fat Boy	89					KN-170C	
82 CI	FLSTF Fat Boy	90-91	HD-1390				KN-170C	
82 CI	FLSTF Fat Boy	92-97	HD-1390		RK-3901*	RK-3901PK	KN-170C	*Round Mirrored
82 CI	FLSTF Fat Boy	92-97	HD-1390		RK-3902*	RK-3902PK	KN-170C	*Tear Mirrored - Mirrored
82 CI	FLSTF Fat Boy	92-97	HD-1390		RK-3911*	RK-3901PK	KN-170C	*Round Grooved - Grooved
82 CI	FLSTF Fat Boy	92-97	HD-1390		RK-3912*	RK-3902PK	KN-170C	*Tear Grooved - Grooved
82 CI	FLSTF Fat Boy	92-97	HD-1390		RK-3921*	RK-3901PK	KN-170C	*Round Flamed - Flamed
82 CI	FLSTF Fat Boy	92-97	HD-1390		RK-3922*	RK-3902PK	KN-170C	*Tear Flamed - Flamed
82 CI	FLSTF Fat Boy	98-99	HD-1390				KN-170C	
82 CI	FLSTF Fat Boy - Non-US	95-99	HD-1396					
82 CI	FLSTN Heritage Softail Nostalgia	93	HD-1390		RK-3901*	RK-3901PK		*Round Mirrored
82 CI	FLSTN Heritage Softail Nostalgia	93	HD-1390		RK-3902*	RK-3902PK		*Tear Mirrored - Mirrored
82 CI	FLSTN Heritage Softail Nostalgia	93	HD-1390		RK-3911*	RK-3901PK		*Round Grooved - Grooved
82 CI	FLSTN Heritage Softail Nostalgia	93	HD-1390		RK-3912*	RK-3902PK		*Tear Grooved - Grooved
82 CI	FLSTN Heritage Softail Nostalgia	93	HD-1390		RK-3921*	RK-3901PK		*Round Flamed - Flamed
82 CI	FLSTN Heritage Softail Nostalgia	93	HD-1390		RK-3922*	RK-3902PK		*Tear Flamed - Flamed
82 CI	FLSTN Heritage Softail Nostalgia	94-95	HD-1390					
82 CI	FLSTN Heritage Softail Special	94-95			RK-3901*	RK-3901PK	KN-170C	*Round Mirrored

2) Requires Two; 3) Requires Three; 4) Requires Four. The use of custom air filter requires removal of air box. Some custom filters and intakes are not legal for sale or use on any pollution controlled motor vehicle in California or states adopting California emission procedures. See knfilters.com for CARB status on each part for a specific vehicle.



Motorcycle - Application Listing

CC	Model	Year	Air Filter	Air Filter Precharger	Custom	Custom Precharger	Oil Filter	Comments
HARLEY DAVIDSON								
82 CI	FLSTN Heritage Softail Special	94-95			RK-3902*	RK-3902PK	KN-170C	*Tear Mirrored - Mirrored
82 CI	FLSTN Heritage Softail Special	94-95			RK-3911*	RK-3901PK	KN-170C	*Round Grooved - Grooved
82 CI	FLSTN Heritage Softail Special	94-95			RK-3912*	RK-3902PK	KN-170C	*Tear Grooved - Grooved
82 CI	FLSTN Heritage Softail Special	94-95			RK-3921*	RK-3901PK	KN-170C	*Round Flamed - Flamed
82 CI	FLSTN Heritage Softail Special	94-95			RK-3922*	RK-3902PK	KN-170C	*Tear Flamed - Flamed
82 CI	FLSTN Heritage Softail Special	96	HD-1390		RK-3901*	RK-3901PK	KN-170C	*Round Mirrored
82 CI	FLSTN Heritage Softail Special	96	HD-1390		RK-3902*	RK-3902PK	KN-170C	*Tear Mirrored - Mirrored
82 CI	FLSTN Heritage Softail Special	96	HD-1390		RK-3911*	RK-3901PK	KN-170C	*Round Grooved - Grooved
82 CI	FLSTN Heritage Softail Special	96	HD-1390		RK-3912*	RK-3902PK	KN-170C	*Tear Grooved - Grooved
82 CI	FLSTN Heritage Softail Special	96	HD-1390		RK-3921*	RK-3901PK	KN-170C	*Round Flamed - Flamed
82 CI	FLSTN Heritage Softail Special	96	HD-1390		RK-3922*	RK-3902PK	KN-170C	*Tear Flamed - Flamed
82 CI	FLSTN Heritage Softail Special	97-98	HD-1390				KN-170C	
82 CI	FLSTN Heritage Softail Special - Non-US	95-96	HD-1396					
82 CI	FLSTS Heritage Springer	97	HD-1390		RK-3901*	RK-3901PK	KN-170C	*Round Mirrored
82 CI	FLSTS Heritage Springer	97	HD-1390		RK-3902*	RK-3902PK	KN-170C	*Tear Mirrored - Mirrored
82 CI	FLSTS Heritage Springer	97	HD-1390		RK-3911*	RK-3901PK	KN-170C	*Round Grooved - Grooved
82 CI	FLSTS Heritage Springer	97	HD-1390		RK-3912*	RK-3902PK	KN-170C	*Tear Grooved - Grooved
82 CI	FLSTS Heritage Springer	97	HD-1390		RK-3921*	RK-3901PK	KN-170C	*Round Flamed - Flamed
82 CI	FLSTS Heritage Springer	97	HD-1390		RK-3922*	RK-3902PK	KN-170C	*Tear Flamed - Flamed
82 CI	FLSTS Heritage Springer	98-99	HD-1390				KN-170C	
82 CI	FLSTS Softail - Non-US	97-99	HD-1396					
82 CI	FLT	80-90					KN-170C	
82 CI	FLT80 Tour Glide	80	HD-2078				KN-170C	
82 CI	FLTC Chrome	88	HD-2086				KN-170C	
82 CI	FLTC Chrome TT	87	HD-2086				KN-170C	
82 CI	FLTC Tour Glide Classic	80					KN-170C	
82 CI	FLTC Tour Glide Classic	81-83	HD-2078				KN-170C	
82 CI	FLTC Tour Glide Classic	84-85	HD-2084				KN-170C	
82 CI	FLTC Tour Glide Classic	86-89	HD-2086				KN-170C	
82 CI	FLTC Tour Glide Classic	90-91	HD-1390				KN-170C	
82 CI	FLTC Tour Glide Classic	92			RK-3901*	RK-3901PK	KN-170C	*Round Mirrored
82 CI	FLTC Tour Glide Classic	92			RK-3902*	RK-3902PK	KN-170C	*Tear Mirrored - Mirrored
82 CI	FLTC Tour Glide Classic	92			RK-3911*	RK-3901PK	KN-170C	*Round Grooved - Grooved
82 CI	FLTC Tour Glide Classic	92			RK-3912*	RK-3902PK	KN-170C	*Tear Grooved - Grooved
82 CI	FLTC Tour Glide Classic	92			RK-3921*	RK-3901PK	KN-170C	*Round Flamed - Flamed
82 CI	FLTC Tour Glide Classic	92			RK-3922*	RK-3902PK	KN-170C	*Tear Flamed - Flamed
82 CI	FLTCU Ultra Tour Glide Annv.	93	HD-1390		RK-3901*	RK-3901PK	KN-170C	*Round Mirrored
82 CI	FLTCU Ultra Tour Glide Annv.	93	HD-1390		RK-3902*	RK-3902PK	KN-170C	*Tear Mirrored - Mirrored
82 CI	FLTCU Ultra Tour Glide Annv.	93	HD-1390		RK-3911*	RK-3901PK	KN-170C	*Round Grooved - Grooved
82 CI	FLTCU Ultra Tour Glide Annv.	93	HD-1390		RK-3912*	RK-3902PK	KN-170C	*Tear Grooved - Grooved
82 CI	FLTCU Ultra Tour Glide Annv.	93	HD-1390		RK-3921*	RK-3901PK	KN-170C	*Round Flamed - Flamed
82 CI	FLTCU Ultra Tour Glide Annv.	93	HD-1390		RK-3922*	RK-3902PK	KN-170C	*Tear Flamed - Flamed
82 CI	FLTCU Ultra Tour Glide Classic	87-88					KN-170C	
82 CI	FLTCU Ultra Tour Glide Classic	89	HD-2086				KN-170C	
82 CI	FLTCU Ultra Tour Glide Classic	90-91	HD-1390				KN-170C	
82 CI	FLTCU Ultra Tour Glide Classic	92-95	HD-1390		RK-3901*	RK-3901PK	KN-170C	*Round Mirrored
82 CI	FLTCU Ultra Tour Glide Classic	92-95	HD-1390		RK-3902*	RK-3902PK	KN-170C	*Tear Mirrored - Mirrored
82 CI	FLTCU Ultra Tour Glide Classic	92-95	HD-1390		RK-3911*	RK-3901PK	KN-170C	*Round Grooved - Grooved
82 CI	FLTCU Ultra Tour Glide Classic	92-95	HD-1390		RK-3912*	RK-3902PK	KN-170C	*Tear Grooved - Grooved
82 CI	FLTCU Ultra Tour Glide Classic	92-95	HD-1390		RK-3921*	RK-3901PK	KN-170C	*Round Flamed - Flamed
82 CI	FLTCU Ultra Tour Glide Classic	92-95	HD-1390		RK-3922*	RK-3902PK	KN-170C	*Tear Flamed - Flamed
82 CI	FLTCUI Ultra Tour Glide Classic F/I	96	HD-1395					
82 CI	FLTR Road Glide	98	HD-1390				KN-170C	
82 CI	FLTRI Road Glide F/I	98	HD-1395				KN-170C	
82 CI	FXB Sturgis	80	HD-2078				KN-173B*	*Black

2) Requires Two; 3) Requires Three; 4) Requires Four. The use of custom air filter requires removal of air box. Some custom filters and intakes are not legal for sale or use on any pollution controlled motor vehicle in California or states adopting California emission procedures. See knfilters.com for CARB status on each part for a specific vehicle.

Motorcycle - Application Listing



CC	Model	Year	Air Filter	Air Filter Precharger	Custom	Custom Precharger	Oil Filter	Comments
HARLEY DAVIDSON								
82 CI	FXB Sturgis	80	HD-2078				KN-173C*	*Chrome
82 CI	FXB Sturgis	82	HD-2078				KN-173B*	*Black
82 CI	FXB Sturgis	82	HD-2078				KN-173C*	*Chrome
82 CI	FXD Dyna Super Glide	95	HD-1390		RK-3901*	RK-3901PK		*Round Mirrored
82 CI	FXD Dyna Super Glide	95	HD-1390		RK-3902*	RK-3902PK		*Tear Mirrored - Mirrored
82 CI	FXD Dyna Super Glide	95	HD-1390		RK-3911*	RK-3901PK		*Round Grooved - Grooved
82 CI	FXD Dyna Super Glide	95	HD-1390		RK-3912*	RK-3902PK		*Tear Grooved - Grooved
82 CI	FXD Dyna Super Glide	95	HD-1390		RK-3921*	RK-3901PK		*Round Flamed - Flamed
82 CI	FXD Dyna Super Glide	95	HD-1390		RK-3922*	RK-3902PK		*Tear Flamed - Flamed
82 CI	FXD Dyna Super Glide	96-97	HD-1390		RK-3901*	RK-3901PK	KN-173B**	*Round Mirrored/ **Black
82 CI	FXD Dyna Super Glide	96-97	HD-1390		RK-3901*	RK-3901PK	KN-173C**	*Round Mirrored/ **Chrome
82 CI	FXD Dyna Super Glide	96-97	HD-1390		RK-3902*	RK-3902PK	KN-173B**	*Tear Mirrored - Mirrored/ **Black
82 CI	FXD Dyna Super Glide	96-97	HD-1390		RK-3902*	RK-3902PK	KN-173C**	*Tear Mirrored - Mirrored/ **Chrome
82 CI	FXD Dyna Super Glide	96-97	HD-1390		RK-3911*	RK-3901PK	KN-173B**	*Round Grooved - Grooved/ **Black
82 CI	FXD Dyna Super Glide	96-97	HD-1390		RK-3911*	RK-3901PK	KN-173C**	*Round Grooved - Grooved/ **Chrome
82 CI	FXD Dyna Super Glide	96-97	HD-1390		RK-3912*	RK-3902PK	KN-173B**	*Tear Grooved - Grooved/ **Black
82 CI	FXD Dyna Super Glide	96-97	HD-1390		RK-3912*	RK-3902PK	KN-173C**	*Tear Grooved - Grooved/ **Chrome
82 CI	FXD Dyna Super Glide	96-97	HD-1390		RK-3921*	RK-3901PK	KN-173B**	*Round Flamed - Flamed/ **Black
82 CI	FXD Dyna Super Glide	96-97	HD-1390		RK-3921*	RK-3901PK	KN-173C**	*Round Flamed - Flamed/ **Chrome
82 CI	FXD Dyna Super Glide	96-97	HD-1390		RK-3922*	RK-3902PK	KN-173B**	*Tear Flamed - Flamed/ **Black
82 CI	FXD Dyna Super Glide	96-97	HD-1390		RK-3922*	RK-3902PK	KN-173C**	*Tear Flamed - Flamed/ **Chrome
82 CI	FXD Dyna Super Glide	98	HD-1390				KN-173B*	*Black
82 CI	FXD Dyna Super Glide	98	HD-1390				KN-173C*	*Chrome
82 CI	FXD Dyna Super Glide - Non-US	95-98	HD-1396					
82 CI	FXDB Dyna Glide Daytona	92	HD-1390		RK-3901*	RK-3901PK	KN-173B**	*Round Mirrored/ **Black
82 CI	FXDB Dyna Glide Daytona	92	HD-1390		RK-3901*	RK-3901PK	KN-173C**	*Round Mirrored/ **Chrome
82 CI	FXDB Dyna Glide Daytona	92	HD-1390		RK-3902*	RK-3902PK	KN-173B**	*Tear Mirrored - Mirrored/ **Black
82 CI	FXDB Dyna Glide Daytona	92	HD-1390		RK-3902*	RK-3902PK	KN-173C**	*Tear Mirrored - Mirrored/ **Chrome
82 CI	FXDB Dyna Glide Daytona	92	HD-1390		RK-3911*	RK-3901PK	KN-173B**	*Round Grooved - Grooved/ **Black
82 CI	FXDB Dyna Glide Daytona	92	HD-1390		RK-3911*	RK-3901PK	KN-173C**	*Round Grooved - Grooved/ **Chrome
82 CI	FXDB Dyna Glide Daytona	92	HD-1390		RK-3912*	RK-3902PK	KN-173B**	*Tear Grooved - Grooved/ **Black
82 CI	FXDB Dyna Glide Daytona	92	HD-1390		RK-3912*	RK-3902PK	KN-173C**	*Tear Grooved - Grooved/ **Chrome
82 CI	FXDB Dyna Glide Daytona	92	HD-1390		RK-3921*	RK-3901PK	KN-173B**	*Round Flamed - Flamed/ **Black
82 CI	FXDB Dyna Glide Daytona	92	HD-1390		RK-3921*	RK-3901PK	KN-173C**	*Round Flamed - Flamed/ **Chrome
82 CI	FXDB Dyna Glide Daytona	92	HD-1390		RK-3922*	RK-3902PK	KN-173B**	*Tear Flamed - Flamed/ **Black
82 CI	FXDB Dyna Glide Daytona	92	HD-1390		RK-3922*	RK-3902PK	KN-173C**	*Tear Flamed - Flamed/ **Chrome
82 CI	FXDB Dyna Glide Sturgis	91	HD-1390				KN-173B*	*Black
82 CI	FXDB Dyna Glide Sturgis	91	HD-1390				KN-173C*	*Chrome
82 CI	FXDC Dyna Glide Custom	92	HD-1390		RK-3901*	RK-3901PK	KN-173B**	*Round Mirrored/ **Black
82 CI	FXDC Dyna Glide Custom	92	HD-1390		RK-3901*	RK-3901PK	KN-173C**	*Round Mirrored/ **Chrome

2) Requires Two; 3) Requires Three; 4) Requires Four. The use of custom air filter requires removal of air box. Some custom filters and intakes are not legal for sale or use on any pollution controlled motor vehicle in California or states adopting California emission procedures. See knfilters.com for CARB status on each part for a specific vehicle.



Motorcycle - Application Listing

CC	Model	Year	Air Filter	Air Filter Precharger	Custom	Custom Precharger	Oil Filter	Comments
HARLEY DAVIDSON								
82 CI	FXDC Dyna Glide Custom	92	HD-1390		RK-3902*	RK-3902PK	KN-173B**	*Tear Mirrored - Mirrored/ **Black
82 CI	FXDC Dyna Glide Custom	92	HD-1390		RK-3902*	RK-3902PK	KN-173C**	*Tear Mirrored - Mirrored/ **Chrome
82 CI	FXDC Dyna Glide Custom	92	HD-1390		RK-3911*	RK-3901PK	KN-173B**	*Round Grooved - Grooved/ **Black
82 CI	FXDC Dyna Glide Custom	92	HD-1390		RK-3911*	RK-3901PK	KN-173C**	*Round Grooved - Grooved/ **Chrome
82 CI	FXDC Dyna Glide Custom	92	HD-1390		RK-3912*	RK-3902PK	KN-173B**	*Tear Grooved - Grooved/ **Black
82 CI	FXDC Dyna Glide Custom	92	HD-1390		RK-3912*	RK-3902PK	KN-173C**	*Tear Grooved - Grooved/ **Chrome
82 CI	FXDC Dyna Glide Custom	92	HD-1390		RK-3921*	RK-3901PK	KN-173B**	*Round Flamed - Flamed/ **Black
82 CI	FXDC Dyna Glide Custom	92	HD-1390		RK-3921*	RK-3901PK	KN-173C**	*Round Flamed - Flamed/ **Chrome
82 CI	FXDC Dyna Glide Custom	92	HD-1390		RK-3922*	RK-3902PK	KN-173B**	*Tear Flamed - Flamed/ **Black
82 CI	FXDC Dyna Glide Custom	92	HD-1390		RK-3922*	RK-3902PK	KN-173C**	*Tear Flamed - Flamed/ **Chrome
82 CI	FXDG Disc Glide	83	HD-2078					
82 CI	FXDL Dyna Low Rider	93	HD-1390				KN-173B*	*Black
82 CI	FXDL Dyna Low Rider	93	HD-1390				KN-173C*	*Chrome
82 CI	FXDL Dyna Low Rider	94-97	HD-1390		RK-3901*	RK-3901PK	KN-173B**	*Round Mirrored/ **Black
82 CI	FXDL Dyna Low Rider	94-97	HD-1390		RK-3901*	RK-3901PK	KN-173C**	*Round Mirrored/ **Chrome
82 CI	FXDL Dyna Low Rider	94-97	HD-1390		RK-3902*	RK-3902PK	KN-173B**	*Tear Mirrored - Mirrored/ **Black
82 CI	FXDL Dyna Low Rider	94-97	HD-1390		RK-3902*	RK-3902PK	KN-173C**	*Tear Mirrored - Mirrored/ **Chrome
82 CI	FXDL Dyna Low Rider	94-97	HD-1390		RK-3911*	RK-3901PK	KN-173B**	*Round Grooved - Grooved/ **Black
82 CI	FXDL Dyna Low Rider	94-97	HD-1390		RK-3911*	RK-3901PK	KN-173C**	*Round Grooved - Grooved/ **Chrome
82 CI	FXDL Dyna Low Rider	94-97	HD-1390		RK-3912*	RK-3902PK	KN-173B**	*Tear Grooved - Grooved/ **Black
82 CI	FXDL Dyna Low Rider	94-97	HD-1390		RK-3912*	RK-3902PK	KN-173C**	*Tear Grooved - Grooved/ **Chrome
82 CI	FXDL Dyna Low Rider	94-97	HD-1390		RK-3921*	RK-3901PK	KN-173B**	*Round Flamed - Flamed/ **Black
82 CI	FXDL Dyna Low Rider	94-97	HD-1390		RK-3921*	RK-3901PK	KN-173C**	*Round Flamed - Flamed/ **Chrome
82 CI	FXDL Dyna Low Rider	94-97	HD-1390		RK-3922*	RK-3902PK	KN-173B**	*Tear Flamed - Flamed/ **Black
82 CI	FXDL Dyna Low Rider	94-97	HD-1390		RK-3922*	RK-3902PK	KN-173C**	*Tear Flamed - Flamed/ **Chrome
82 CI	FXDL Dyna Low Rider	98	HD-1390				KN-173B*	*Black
82 CI	FXDL Dyna Low Rider	98	HD-1390				KN-173C*	*Chrome
82 CI	FXDL Dyna Low Rider - Non-US	95-98	HD-1396					
82 CI	FXDS Dyna Convertible	96-97	HD-1390		RK-3901*	RK-3901PK	KN-173B**	*Round Mirrored/ **Black
82 CI	FXDS Dyna Convertible	96-97	HD-1390		RK-3901*	RK-3901PK	KN-173C**	*Round Mirrored/ **Chrome
82 CI	FXDS Dyna Convertible	96-97	HD-1390		RK-3902*	RK-3902PK	KN-173B**	*Tear Mirrored - Mirrored/ **Black
82 CI	FXDS Dyna Convertible	96-97	HD-1390		RK-3902*	RK-3902PK	KN-173C**	*Tear Mirrored - Mirrored/ **Chrome
82 CI	FXDS Dyna Convertible	96-97	HD-1390		RK-3911*	RK-3901PK	KN-173B**	*Round Grooved - Grooved/ **Black
82 CI	FXDS Dyna Convertible	96-97	HD-1390		RK-3911*	RK-3901PK	KN-173C**	*Round Grooved - Grooved/ **Chrome
82 CI	FXDS Dyna Convertible	96-97	HD-1390		RK-3912*	RK-3902PK	KN-173B**	*Tear Grooved - Grooved/ **Black
82 CI	FXDS Dyna Convertible	96-97	HD-1390		RK-3912*	RK-3902PK	KN-173C**	*Tear Grooved - Grooved/ **Chrome

2) Requires Two; 3) Requires Three; 4) Requires Four. The use of custom air filter requires removal of air box. Some custom filters and intakes are not legal for sale or use on any pollution controlled motor vehicle in California or states adopting California emission procedures. See knfilters.com for CARB status on each part for a specific vehicle.

Motorcycle - Application Listing



CC	Model	Year	Air Filter	Air Filter Precharger	Custom	Custom Precharger	Oil Filter	Comments
HARLEY DAVIDSON								
82 CI	FXDS Dyna Convertible	96-97	HD-1390		RK-3921*	RK-3901PK	KN-173B**	*Round Flamed - Flamed/ **Black
82 CI	FXDS Dyna Convertible	96-97	HD-1390		RK-3921*	RK-3901PK	KN-173C**	*Round Flamed - Flamed/ **Chrome
82 CI	FXDS Dyna Convertible	96-97	HD-1390		RK-3922*	RK-3902PK	KN-173B**	*Tear Flamed - Flamed/ **Black
82 CI	FXDS Dyna Convertible	96-97	HD-1390		RK-3922*	RK-3902PK	KN-173C**	*Tear Flamed - Flamed/ **Chrome
82 CI	FXDS Dyna Convertible	98	HD-1390				KN-173B*	*Black
82 CI	FXDS Dyna Convertible	98	HD-1390				KN-173C*	*Chrome
82 CI	FXDS Dyna Convertible - Non-US	95-98	HD-1396					
82 CI	FXDS Dyna Low Rider Conv.	94-95	HD-1390		RK-3901*	RK-3901PK		*Round Mirrored
82 CI	FXDS Dyna Low Rider Conv.	94-95	HD-1390		RK-3902*	RK-3902PK		*Tear Mirrored - Mirrored
82 CI	FXDS Dyna Low Rider Conv.	94-95	HD-1390		RK-3911*	RK-3901PK		*Round Grooved - Grooved
82 CI	FXDS Dyna Low Rider Conv.	94-95	HD-1390		RK-3912*	RK-3902PK		*Tear Grooved - Grooved
82 CI	FXDS Dyna Low Rider Conv.	94-95	HD-1390		RK-3921*	RK-3901PK		*Round Flamed - Flamed
82 CI	FXDS Dyna Low Rider Conv.	94-95	HD-1390		RK-3922*	RK-3902PK		*Tear Flamed - Flamed
82 CI	FXDWG Dyna Wide Glide	93-97	HD-1390		RK-3901*	RK-3901PK	KN-173B**	*Round Mirrored/ **Black
82 CI	FXDWG Dyna Wide Glide	93-97	HD-1390		RK-3901*	RK-3901PK	KN-173C**	*Round Mirrored/ **Chrome
82 CI	FXDWG Dyna Wide Glide	93-97	HD-1390		RK-3902*	RK-3902PK	KN-173B**	*Tear Mirrored - Mirrored/ **Black
82 CI	FXDWG Dyna Wide Glide	93-97	HD-1390		RK-3902*	RK-3902PK	KN-173C**	*Tear Mirrored - Mirrored/ **Chrome
82 CI	FXDWG Dyna Wide Glide	93-97	HD-1390		RK-3911*	RK-3901PK	KN-173B**	*Round Grooved - Grooved/ **Black
82 CI	FXDWG Dyna Wide Glide	93-97	HD-1390		RK-3911*	RK-3901PK	KN-173C**	*Round Grooved - Grooved/ **Chrome
82 CI	FXDWG Dyna Wide Glide	93-97	HD-1390		RK-3912*	RK-3902PK	KN-173B**	*Tear Grooved - Grooved/ **Black
82 CI	FXDWG Dyna Wide Glide	93-97	HD-1390		RK-3912*	RK-3902PK	KN-173C**	*Tear Grooved - Grooved/ **Chrome
82 CI	FXDWG Dyna Wide Glide	93-97	HD-1390		RK-3921*	RK-3901PK	KN-173B**	*Round Flamed - Flamed/ **Black
82 CI	FXDWG Dyna Wide Glide	93-97	HD-1390		RK-3921*	RK-3901PK	KN-173C**	*Round Flamed - Flamed/ **Chrome
82 CI	FXDWG Dyna Wide Glide	93-97	HD-1390		RK-3922*	RK-3902PK	KN-173B**	*Tear Flamed - Flamed/ **Black
82 CI	FXDWG Dyna Wide Glide	93-97	HD-1390		RK-3922*	RK-3902PK	KN-173C**	*Tear Flamed - Flamed/ **Chrome
82 CI	FXDWG Dyna Wide Glide	98	HD-1390				KN-173B*	*Black
82 CI	FXDWG Dyna Wide Glide	98	HD-1390				KN-173C*	*Chrome
82 CI	FXDWG Dyna Wide Glide - Non-US	95-98	HD-1396					
82 CI	FXE Super Glide	81	HD-2078					
82 CI	FXE Super Glide	82-83	HD-2078				KN-172B*	*Black
82 CI	FXE Super Glide	82-83	HD-2078				KN-172C*	*Chrome
82 CI	FXE Super Glide	84	HD-2084				KN-172B*	*Black
82 CI	FXE Super Glide	84	HD-2084				KN-172C*	*Chrome
82 CI	FXEF Fat Bob	79-81	HD-2078					
82 CI	FXEF Super Glide Fat Bob	84-85	HD-2084				KN-172B*	*Black
82 CI	FXEF Super Glide Fat Bob	84-85	HD-2084				KN-172C*	*Chrome
82 CI	FXH Electra Glide	80-81	HD-2078					
82 CI	FXLR Low Rider Custom	87-89	HD-2086				KN-170C	
82 CI	FXLR Low Rider Custom	90-91	HD-1390				KN-170C	
82 CI	FXLR Low Rider Custom	92-94	HD-1390		RK-3901*	RK-3901PK	KN-170C	*Round Mirrored
82 CI	FXLR Low Rider Custom	92-94	HD-1390		RK-3902*	RK-3902PK	KN-170C	*Tear Mirrored - Mirrored
82 CI	FXLR Low Rider Custom	92-94	HD-1390		RK-3911*	RK-3901PK	KN-170C	*Round Grooved - Grooved
82 CI	FXLR Low Rider Custom	92-94	HD-1390		RK-3912*	RK-3902PK	KN-170C	*Tear Grooved - Grooved
82 CI	FXLR Low Rider Custom	92-94	HD-1390		RK-3921*	RK-3901PK	KN-170C	*Round Flamed - Flamed
82 CI	FXLR Low Rider Custom	92-94	HD-1390		RK-3922*	RK-3902PK	KN-170C	*Tear Flamed - Flamed

2) Requires Two; 3) Requires Three; 4) Requires Four. The use of custom air filter requires removal of air box. Some custom filters and intakes are not legal for sale or use on any pollution controlled motor vehicle in California or states adopting California emission procedures. See knfilters.com for CARB status on each part for a specific vehicle.



Motorcycle - Application Listing

CC	Model	Year	Air Filter	Air Filter Precharger	Custom	Custom Precharger	Oil Filter	Comments
HARLEY DAVIDSON								
82 CI	FXLR Low Rider Custom Annv.	93	HD-1390		RK-3901*	RK-3901PK	KN-170C	*Round Mirrored
82 CI	FXLR Low Rider Custom Annv.	93	HD-1390		RK-3902*	RK-3902PK	KN-170C	*Tear Mirrored - Mirrored
82 CI	FXLR Low Rider Custom Annv.	93	HD-1390		RK-3911*	RK-3901PK	KN-170C	*Round Grooved - Grooved
82 CI	FXLR Low Rider Custom Annv.	93	HD-1390		RK-3912*	RK-3902PK	KN-170C	*Tear Grooved - Grooved
82 CI	FXLR Low Rider Custom Annv.	93	HD-1390		RK-3921*	RK-3901PK	KN-170C	*Round Flamed - Flamed
82 CI	FXLR Low Rider Custom Annv.	93	HD-1390		RK-3922*	RK-3902PK	KN-170C	*Tear Flamed - Flamed
82 CI	FXR Super Glide	84-85					KN-170C	
82 CI	FXR Super Glide	86-89	HD-2086				KN-170C	
82 CI	FXR Super Glide	90-91	HD-1390				KN-170C	
82 CI	FXR Super Glide	92-93	HD-1390		RK-3901*	RK-3901PK	KN-170C	*Round Mirrored
82 CI	FXR Super Glide	92-93	HD-1390		RK-3902*	RK-3902PK	KN-170C	*Tear Mirrored - Mirrored
82 CI	FXR Super Glide	92-93	HD-1390		RK-3911*	RK-3901PK	KN-170C	*Round Grooved - Grooved
82 CI	FXR Super Glide	92-93	HD-1390		RK-3912*	RK-3902PK	KN-170C	*Tear Grooved - Grooved
82 CI	FXR Super Glide	92-93	HD-1390		RK-3921*	RK-3901PK	KN-170C	*Round Flamed - Flamed
82 CI	FXR Super Glide	92-93	HD-1390		RK-3922*	RK-3902PK	KN-170C	*Tear Flamed - Flamed
82 CI	FXR Super Glide	94			RK-3901*	RK-3901PK	KN-170C	*Round Mirrored
82 CI	FXR Super Glide	94			RK-3902*	RK-3902PK	KN-170C	*Tear Mirrored - Mirrored
82 CI	FXR Super Glide	94			RK-3911*	RK-3901PK	KN-170C	*Round Grooved - Grooved
82 CI	FXR Super Glide	94			RK-3912*	RK-3902PK	KN-170C	*Tear Grooved - Grooved
82 CI	FXR Super Glide	94			RK-3921*	RK-3901PK	KN-170C	*Round Flamed - Flamed
82 CI	FXR Super Glide	94			RK-3922*	RK-3902PK	KN-170C	*Tear Flamed - Flamed
82 CI	FXR Super Glide II	82-83	HD-2078				KN-170C	
82 CI	FXRC Low Glide Custom	85	HD-2084					
82 CI	FXRC Low Glide Custom	86	HD-2086					
82 CI	FXRC Low Glide Custom	87	HD-2086				KN-170C	
82 CI	FXRD Grand Touring	86	HD-2086				KN-170C	
82 CI	FXRDG Disc Glide	84	HD-2084					
82 CI	FXRS Low Glide	82-83					KN-170C	
82 CI	FXRS Low Glide	84-85	HD-2084					
82 CI	FXRS Low Rider	86	HD-2086					
82 CI	FXRS Low Rider	87-89	HD-2086				KN-170C	
82 CI	FXRS Low Rider	90-91	HD-1390				KN-170C	
82 CI	FXRS Low Rider	92	HD-1390		RK-3901*	RK-3901PK	KN-170C	*Round Mirrored
82 CI	FXRS Low Rider	92	HD-1390		RK-3902*	RK-3902PK	KN-170C	*Tear Mirrored - Mirrored
82 CI	FXRS Low Rider	92	HD-1390		RK-3911*	RK-3901PK	KN-170C	*Round Grooved - Grooved
82 CI	FXRS Low Rider	92	HD-1390		RK-3912*	RK-3902PK	KN-170C	*Tear Grooved - Grooved
82 CI	FXRS Low Rider	92	HD-1390		RK-3921*	RK-3901PK	KN-170C	*Round Flamed - Flamed
82 CI	FXRS Low Rider	92	HD-1390		RK-3922*	RK-3902PK	KN-170C	*Tear Flamed - Flamed
82 CI	FXRS Low Rider	93			RK-3901*	RK-3901PK	KN-170C	*Round Mirrored
82 CI	FXRS Low Rider	93			RK-3902*	RK-3902PK	KN-170C	*Tear Mirrored - Mirrored
82 CI	FXRS Low Rider	93			RK-3911*	RK-3901PK	KN-170C	*Round Grooved - Grooved
82 CI	FXRS Low Rider	93			RK-3912*	RK-3902PK	KN-170C	*Tear Grooved - Grooved
82 CI	FXRS Low Rider	93			RK-3921*	RK-3901PK	KN-170C	*Round Flamed - Flamed
82 CI	FXRS Low Rider	93			RK-3922*	RK-3902PK	KN-170C	*Tear Flamed - Flamed
82 CI	FXRS Low Rider	94					KN-170C	
82 CI	FXRS Low Rider Conv.	89	HD-2086					
82 CI	FXRS Low Rider Conv.	90-91	HD-1390				KN-170C	
82 CI	FXRS Low Rider Conv.	92-93	HD-1390		RK-3901*	RK-3901PK	KN-170C	*Round Mirrored
82 CI	FXRS Low Rider Conv.	92-93	HD-1390		RK-3902*	RK-3902PK	KN-170C	*Tear Mirrored - Mirrored
82 CI	FXRS Low Rider Conv.	92-93	HD-1390		RK-3911*	RK-3901PK	KN-170C	*Round Grooved - Grooved
82 CI	FXRS Low Rider Conv.	92-93	HD-1390		RK-3912*	RK-3902PK	KN-170C	*Tear Grooved - Grooved
82 CI	FXRS Low Rider Conv.	92-93	HD-1390		RK-3921*	RK-3901PK	KN-170C	*Round Flamed - Flamed
82 CI	FXRS Low Rider Conv.	92-93	HD-1390		RK-3922*	RK-3902PK	KN-170C	*Tear Flamed - Flamed
82 CI	FXRS Low Rider Conv.	94					KN-170C	
82 CI	FXRS Low Rider Sport	86-88	HD-2086					

2) Requires Two; 3) Requires Three; 4) Requires Four. The use of custom air filter requires removal of air box. Some custom filters and intakes are not legal for sale or use on any pollution controlled motor vehicle in California or states adopting California emission procedures. See knfilters.com for CARB status on each part for a specific vehicle.

Motorcycle - Application Listing



CC	Model	Year	Air Filter	Air Filter Precharger	Custom	Custom Precharger	Oil Filter	Comments
HARLEY DAVIDSON								
82 CI	FXRS Super Glide II	82-83	HD-2078					
82 CI	FXRS-SP Low Rider Sport	89	HD-2086				KN-170C	
82 CI	FXRS-SP Low Rider Sport	90-91	HD-1390				KN-170C	
82 CI	FXRS-SP Low Rider Sport	92-93	HD-1390		RK-3901*	RK-3901PK	KN-170C	*Round Mirrored
82 CI	FXRS-SP Low Rider Sport	92-93	HD-1390		RK-3902*	RK-3902PK	KN-170C	*Tear Mirrored - Mirrored
82 CI	FXRS-SP Low Rider Sport	92-93	HD-1390		RK-3911*	RK-3901PK	KN-170C	*Round Grooved - Grooved
82 CI	FXRS-SP Low Rider Sport	92-93	HD-1390		RK-3912*	RK-3902PK	KN-170C	*Tear Grooved - Grooved
82 CI	FXRS-SP Low Rider Sport	92-93	HD-1390		RK-3921*	RK-3901PK	KN-170C	*Round Flamed - Flamed
82 CI	FXRS-SP Low Rider Sport	92-93	HD-1390		RK-3922*	RK-3902PK	KN-170C	*Tear Flamed - Flamed
82 CI	FXRT Sport Glide	83	HD-2078				KN-170C	
82 CI	FXRT Sport Glide	84-85	HD-2084				KN-170C	
82 CI	FXRT Sport Glide	86-89	HD-2086				KN-170C	
82 CI	FXRT Sport Glide	90-91	HD-1390					
82 CI	FXRT Sport Glide	92	HD-1390		RK-3901*	RK-3901PK		*Round Mirrored
82 CI	FXRT Sport Glide	92	HD-1390		RK-3902*	RK-3902PK		*Tear Mirrored - Mirrored
82 CI	FXRT Sport Glide	92	HD-1390		RK-3911*	RK-3901PK		*Round Grooved - Grooved
82 CI	FXRT Sport Glide	92	HD-1390		RK-3912*	RK-3902PK		*Tear Grooved - Grooved
82 CI	FXRT Sport Glide	92	HD-1390		RK-3921*	RK-3901PK		*Round Flamed - Flamed
82 CI	FXRT Sport Glide	92	HD-1390		RK-3922*	RK-3902PK		*Tear Flamed - Flamed
82 CI	FXS Low Rider	79-82	HD-2078					
82 CI	FXSB Low Rider	83	HD-2078					
82 CI	FXSB Low Rider	84-85	HD-2084					
82 CI	FXST Softail	84-85	HD-2084				KN-170C	
82 CI	FXST Softail	86	HD-2086					
82 CI	FXST Softail	87-89	HD-2086				KN-170C	
82 CI	FXST Softail	90	HD-1390				KN-170C	
82 CI	FXST Softail - Non-US	99	HD-1396					
82 CI	FXST Softail Standard	99	HD-1390					
82 CI	FXSTB Night Train	99	HD-1390				KN-170C	
82 CI	FXSTB Softail - Non-US	99	HD-1396					
82 CI	FXSTC Softail Custom	86	HD-2086					
82 CI	FXSTC Softail Custom	87-89	HD-2086				KN-170C	
82 CI	FXSTC Softail Custom	90-91	HD-1390				KN-170C	
82 CI	FXSTC Softail Custom	92-97	HD-1390		RK-3901*	RK-3901PK	KN-170C	*Round Mirrored
82 CI	FXSTC Softail Custom	92-97	HD-1390		RK-3902*	RK-3902PK	KN-170C	*Tear Mirrored - Mirrored
82 CI	FXSTC Softail Custom	92-97	HD-1390		RK-3911*	RK-3901PK	KN-170C	*Round Grooved - Grooved
82 CI	FXSTC Softail Custom	92-97	HD-1390		RK-3912*	RK-3902PK	KN-170C	*Tear Grooved - Grooved
82 CI	FXSTC Softail Custom	92-97	HD-1390		RK-3921*	RK-3901PK	KN-170C	*Round Flamed - Flamed
82 CI	FXSTC Softail Custom	92-97	HD-1390		RK-3922*	RK-3902PK	KN-170C	*Tear Flamed - Flamed
82 CI	FXSTC Softail Custom	98-99	HD-1390				KN-170C	
82 CI	FXSTC Softail Custom	00					KN-171C*	*Black=KN-171B
82 CI	FXSTC Softail Custom - Non-US	95-99	HD-1396					
82 CI	FXSTS Springer Softail	87					KN-170C	
82 CI	FXSTS Springer Softail	88-89	HD-2086				KN-170C	
82 CI	FXSTS Springer Softail	90-91	HD-1390				KN-170C	
82 CI	FXSTS Springer Softail	92-97	HD-1390		RK-3901*	RK-3901PK	KN-170C	*Round Mirrored
82 CI	FXSTS Springer Softail	92-97	HD-1390		RK-3902*	RK-3902PK	KN-170C	*Tear Mirrored - Mirrored
82 CI	FXSTS Springer Softail	92-97	HD-1390		RK-3911*	RK-3901PK	KN-170C	*Round Grooved - Grooved
82 CI	FXSTS Springer Softail	92-97	HD-1390		RK-3912*	RK-3902PK	KN-170C	*Tear Grooved - Grooved
82 CI	FXSTS Springer Softail	92-97	HD-1390		RK-3921*	RK-3901PK	KN-170C	*Round Flamed - Flamed
82 CI	FXSTS Springer Softail	92-97	HD-1390		RK-3922*	RK-3902PK	KN-170C	*Tear Flamed - Flamed
82 CI	FXSTS Springer Softail	98-99	HD-1390				KN-170C	
82 CI	FXSTS Springer Softail - Non-US	95-99	HD-1396					
82 CI	FXSTSB Bad Boy	95	HD-1390		RK-3901*	RK-3901PK		*Round Mirrored
82 CI	FXSTSB Bad Boy	95	HD-1390		RK-3902*	RK-3902PK		*Tear Mirrored - Mirrored

2) Requires Two; 3) Requires Three; 4) Requires Four. The use of custom air filter requires removal of air box. Some custom filters and intakes are not legal for sale or use on any pollution controlled motor vehicle in California or states adopting California emission procedures. See knfilters.com for CARB status on each part for a specific vehicle.



Motorcycle - Application Listing

CC	Model	Year	Air Filter	Air Filter Precharger	Custom	Custom Precharger	Oil Filter	Comments
HARLEY DAVIDSON								
82 CI	FXSTSB Bad Boy	95	HD-1390		RK-3911*	RK-3901PK		*Round Grooved - Grooved
82 CI	FXSTSB Bad Boy	95	HD-1390		RK-3912*	RK-3902PK		*Tear Grooved - Grooved
82 CI	FXSTSB Bad Boy	95	HD-1390		RK-3921*	RK-3901PK		*Round Flamed - Flamed
82 CI	FXSTSB Bad Boy	95	HD-1390		RK-3922*	RK-3902PK		*Tear Flamed - Flamed
82 CI	FXSTSB Bad Boy	96	HD-1390		RK-3901*	RK-3901PK	KN-170C	*Round Mirrored
82 CI	FXSTSB Bad Boy	96	HD-1390		RK-3902*	RK-3902PK	KN-170C	*Tear Mirrored - Mirrored
82 CI	FXSTSB Bad Boy	96	HD-1390		RK-3911*	RK-3901PK	KN-170C	*Round Grooved - Grooved
82 CI	FXSTSB Bad Boy	96	HD-1390		RK-3912*	RK-3902PK	KN-170C	*Tear Grooved - Grooved
82 CI	FXSTSB Bad Boy	96	HD-1390		RK-3921*	RK-3901PK	KN-170C	*Round Flamed - Flamed
82 CI	FXSTSB Bad Boy	96	HD-1390		RK-3922*	RK-3902PK	KN-170C	*Tear Flamed - Flamed
82 CI	FXSTSB Bad Boy	97	HD-1390		RK-3901*	RK-3901PK		*Round Mirrored
82 CI	FXSTSB Bad Boy	97	HD-1390		RK-3902*	RK-3902PK		*Tear Mirrored - Mirrored
82 CI	FXSTSB Bad Boy	97	HD-1390		RK-3911*	RK-3901PK		*Round Grooved - Grooved
82 CI	FXSTSB Bad Boy	97	HD-1390		RK-3912*	RK-3902PK		*Tear Grooved - Grooved
82 CI	FXSTSB Bad Boy	97	HD-1390		RK-3921*	RK-3901PK		*Round Flamed - Flamed
82 CI	FXSTSB Bad Boy	97	HD-1390		RK-3922*	RK-3902PK		*Tear Flamed - Flamed
82 CI	FXSTSB Bad Boy - Non-US	95-97	HD-1396					
82 CI	FXWG Wide Glide	80-81	HD-2078					
82 CI	FXWG Wide Glide	82-83	HD-2078				KN-172B*	*Black
82 CI	FXWG Wide Glide	82-83	HD-2078				KN-172C*	*Chrome
82 CI	FXWG Wide Glide	84-85	HD-2084				KN-172B*	*Black
82 CI	FXWG Wide Glide	84-85	HD-2084				KN-172C*	*Chrome
82 CI	FXWG Wide Glide	86	HD-2086				KN-172B*	*Black
82 CI	FXWG Wide Glide	86	HD-2086				KN-172C*	*Chrome
88 CI	FLHR Road King	99-06	HD-1499		RK-3909-1*		KN-171C**	*w/1-5/8 inch Tall Filter/ **Black=KN-171B
88 CI	FLHR Road King	99-06	HD-1499		RK-3910-1*		KN-171C**	*w/2-1/4 inch Tall Filter/ **Black=KN-171B
88 CI	FLHRCI Road King Classic F/I	99-01	HD-8899		RK-3932*		KN-171C**	*w/Delphi Fuel Injection/ **Black=KN-171B
88 CI	FLHRCI Road King Classic F/I	99-01	HD-8899		RK-3932B*		KN-171C**	*w/Delphi Fuel Injection/ **Black=KN-171B
88 CI	FLHRCI Road King Classic F/I	99-01	HD-8899		RK-3932X*		KN-171C**	*w/Delphi Fuel Injection/ **Black=KN-171B
88 CI	FLHRCI Road King Classic F/I	99-01	HD-8899		RK-3932XB*		KN-171C**	*w/Delphi Fuel Injection/ **Black=KN-171B
88 CI	FLHRCI Road King Classic F/I	99-01	HD-8899		RK-3933*	HD-0800DK	KN-171C**	*w/Delphi Fuel Injection/ **Black=KN-171B
88 CI	FLHRCI Road King Classic F/I	99-01	HD-8899		RK-3933B*	HD-0800DK	KN-171C**	*w/Delphi Fuel Injection/ **Black=KN-171B
88 CI	FLHRCI Road King Classic F/I	99-01	HD-8899		RK-3933X*		KN-171C**	*w/Delphi Fuel Injection/ **Black=KN-171B
88 CI	FLHRCI Road King Classic F/I	99-01	HD-8899		RK-3933XB*		KN-171C**	*w/Delphi Fuel Injection/ **Black=KN-171B
88 CI	FLHRCI Road King Classic F/I	99-01	HD-8899		RK-3934*	RK-3901PK	KN-171C**	*w/Delphi Fuel Injection/ **Black=KN-171B
88 CI	FLHRCI Road King Classic F/I	99-01	HD-8899		RK-3935*	RK-3902PK	KN-171C**	*w/Delphi Fuel Injection/ **Black=KN-171B
88 CI	FLHRCI Road King Classic F/I	02-06	HD-1499		63-1125*	RC-3680DK	KN-171C**	*Exc. Lower Fairings/ **Black=KN-171B
88 CI	FLHRCI Road King Classic F/I	02-06	HD-1499		63-1125P*	RC-3680DK	KN-171C**	*Exc. Lower Fairings/ **Black=KN-171B
88 CI	FLHRCI Road King Classic F/I	02-06	HD-1499		63-1137*		KN-171C**	*Exc. Lower Fairings/ **Black=KN-171B
88 CI	FLHRCI Road King Classic F/I	02-06	HD-1499		63-1137S*		KN-171C**	*Exc. Lower Fairings/ **Black=KN-171B
88 CI	FLHRCI Road King Classic F/I	02-06	HD-1499		RK-3909-1*		KN-171C**	*w/1-5/8 inch Tall Filter/ **Black=KN-171B
88 CI	FLHRCI Road King Classic F/I	02-06	HD-1499		RK-3910-1*		KN-171C**	*w/2-1/4 inch Tall Filter/ **Black=KN-171B

2) Requires Two; 3) Requires Three; 4) Requires Four. The use of custom air filter requires removal of air box. Some custom filters and intakes are not legal for sale or use on any pollution controlled motor vehicle in California or states adopting California emission procedures. See knfilters.com for CARB status on each part for a specific vehicle.

Motorcycle - Application Listing



CC	Model	Year	Air Filter	Air Filter Precharger	Custom	Custom Precharger	Oil Filter	Comments
HARLEY DAVIDSON								
88 CI	FLHRCI Road King Classic F/I	02-06	HD-1499		RK-3932		KN-171C*	*Black=KN-171B
88 CI	FLHRCI Road King Classic F/I	02-06	HD-1499		RK-3932B		KN-171C*	*Black=KN-171B
88 CI	FLHRCI Road King Classic F/I	02-06	HD-1499		RK-3932X		KN-171C*	*Black=KN-171B
88 CI	FLHRCI Road King Classic F/I	02-06	HD-1499		RK-3932XB		KN-171C*	*Black=KN-171B
88 CI	FLHRCI Road King Classic F/I	02-06	HD-1499		RK-3933	HD-0800DK	KN-171C*	*Black=KN-171B
88 CI	FLHRCI Road King Classic F/I	02-06	HD-1499		RK-3933B	HD-0800DK	KN-171C*	*Black=KN-171B
88 CI	FLHRCI Road King Classic F/I	02-06	HD-1499		RK-3933X		KN-171C*	*Black=KN-171B
88 CI	FLHRCI Road King Classic F/I	02-06	HD-1499		RK-3933XB		KN-171C*	*Black=KN-171B
88 CI	FLHRCI Road King Classic F/I	02-06	HD-1499		RK-3934	RK-3901PK	KN-171C*	*Black=KN-171B
88 CI	FLHRCI Road King Classic F/I	02-06	HD-1499		RK-3935	RK-3902PK	KN-171C*	*Black=KN-171B
88 CI	FLHRCI Road King Classic F/I	02-06	HD-1499		RK-3950*		KN-171C**	*Exc. Lower Fairings/ **Black=KN-171B
88 CI	FLHRCI Road King Classic F/I	02-06	HD-1499		RK-3950S*		KN-171C**	*Exc. Lower Fairings/ **Black=KN-171B
88 CI	FLHRI Electra Glide Road King F/I	00-01	HD-8899				KN-171C*	*Black=KN-171B
88 CI	FLHRI Road King F/I	00	HD-8899		RK-3932*			*w/Delphi Fuel Injection
88 CI	FLHRI Road King F/I	00	HD-8899		RK-3932B*			*w/Delphi Fuel Injection
88 CI	FLHRI Road King F/I	00	HD-8899		RK-3932X*			*w/Delphi Fuel Injection
88 CI	FLHRI Road King F/I	00	HD-8899		RK-3932XB*			*w/Delphi Fuel Injection
88 CI	FLHRI Road King F/I	00	HD-8899		RK-3933*	HD-0800DK		*w/Delphi Fuel Injection
88 CI	FLHRI Road King F/I	00	HD-8899		RK-3933B*	HD-0800DK		*w/Delphi Fuel Injection
88 CI	FLHRI Road King F/I	00	HD-8899		RK-3933X*			*w/Delphi Fuel Injection
88 CI	FLHRI Road King F/I	00	HD-8899		RK-3933XB*			*w/Delphi Fuel Injection
88 CI	FLHRI Road King F/I	00	HD-8899		RK-3934*	RK-3901PK		*w/Delphi Fuel Injection
88 CI	FLHRI Road King F/I	00	HD-8899		RK-3935*	RK-3902PK		*w/Delphi Fuel Injection
88 CI	FLHRI Road King F/I	01	HD-8899		RK-3932*		KN-171C**	*w/Delphi Fuel Injection/ **Black=KN-171B
88 CI	FLHRI Road King F/I	01	HD-8899		RK-3932B*		KN-171C**	*w/Delphi Fuel Injection/ **Black=KN-171B
88 CI	FLHRI Road King F/I	01	HD-8899		RK-3932X*		KN-171C**	*w/Delphi Fuel Injection/ **Black=KN-171B
88 CI	FLHRI Road King F/I	01	HD-8899		RK-3932XB*		KN-171C**	*w/Delphi Fuel Injection/ **Black=KN-171B
88 CI	FLHRI Road King F/I	01	HD-8899		RK-3933*	HD-0800DK	KN-171C**	*w/Delphi Fuel Injection/ **Black=KN-171B
88 CI	FLHRI Road King F/I	01	HD-8899		RK-3933B*	HD-0800DK	KN-171C**	*w/Delphi Fuel Injection/ **Black=KN-171B
88 CI	FLHRI Road King F/I	01	HD-8899		RK-3933X*		KN-171C**	*w/Delphi Fuel Injection/ **Black=KN-171B
88 CI	FLHRI Road King F/I	01	HD-8899		RK-3933XB*		KN-171C**	*w/Delphi Fuel Injection/ **Black=KN-171B
88 CI	FLHRI Road King F/I	01	HD-8899		RK-3934*	RK-3901PK	KN-171C**	*w/Delphi Fuel Injection/ **Black=KN-171B
88 CI	FLHRI Road King F/I	01	HD-8899		RK-3935*	RK-3902PK	KN-171C**	*w/Delphi Fuel Injection/ **Black=KN-171B
88 CI	FLHRI Road King F/I	02-06	HD-1499		RK-3932		KN-171C*	*Black=KN-171B
88 CI	FLHRI Road King F/I	02-06	HD-1499		RK-3932B		KN-171C*	*Black=KN-171B
88 CI	FLHRI Road King F/I	02-06	HD-1499		RK-3932X		KN-171C*	*Black=KN-171B
88 CI	FLHRI Road King F/I	02-06	HD-1499		RK-3932XB		KN-171C*	*Black=KN-171B
88 CI	FLHRI Road King F/I	02-06	HD-1499		RK-3933	HD-0800DK	KN-171C*	*Black=KN-171B
88 CI	FLHRI Road King F/I	02-06	HD-1499		RK-3933B	HD-0800DK	KN-171C*	*Black=KN-171B
88 CI	FLHRI Road King F/I	02-06	HD-1499		RK-3933X		KN-171C*	*Black=KN-171B
88 CI	FLHRI Road King F/I	02-06	HD-1499		RK-3933XB		KN-171C*	*Black=KN-171B
88 CI	FLHRI Road King F/I	02-06	HD-1499		RK-3934	RK-3901PK	KN-171C*	*Black=KN-171B
88 CI	FLHRI Road King F/I	02-06	HD-1499		RK-3935	RK-3902PK	KN-171C*	*Black=KN-171B
88 CI	FLHRI Road King F/I	03-06	HD-1499		63-1125*	RC-3680DK	KN-171C**	*Exc. Lower Fairings/ **Black=KN-171B
88 CI	FLHRI Road King F/I	03-06	HD-1499		63-1125P*	RC-3680DK	KN-171C**	*Exc. Lower Fairings/ **Black=KN-171B

2) Requires Two; 3) Requires Three; 4) Requires Four. The use of custom air filter requires removal of air box. Some custom filters and intakes are not legal for sale or use on any pollution controlled motor vehicle in California or states adopting California emission procedures. See knfilters.com for CARB status on each part for a specific vehicle.



Motorcycle - Application Listing

CC	Model	Year	Air Filter	Air Filter Precharger	Custom	Custom Precharger	Oil Filter	Comments
HARLEY DAVIDSON								
88 CI	FLHRI Road King F/I	03-06	HD-1499		63-1137*		KN-171C**	*Exc. Lower Fairings/ **Black=KN-171B
88 CI	FLHRI Road King F/I	03-06	HD-1499		63-1137S*		KN-171C**	*Exc. Lower Fairings/ **Black=KN-171B
88 CI	FLHRI Road King F/I	03-06	HD-1499		RK-3909-1*		KN-171C**	*w/1-5/8 inch Tall Filter/ **Black=KN-171B
88 CI	FLHRI Road King F/I	03-06	HD-1499		RK-3910-1*		KN-171C**	*w/2-1/4 inch Tall Filter/ **Black=KN-171B
88 CI	FLHRI Road King F/I	03-06	HD-1499		RK-3950*		KN-171C**	*Exc. Lower Fairings/ **Black=KN-171B
88 CI	FLHRI Road King F/I	03-06	HD-1499		RK-3950S*		KN-171C**	*Exc. Lower Fairings/ **Black=KN-171B
88 CI	FLHRS Road King Custom	04-06	HD-1499		RK-3909-1*		KN-171C**	*w/1-5/8 inch Tall Filter/ **Black=KN-171B
88 CI	FLHRS Road King Custom	04-06	HD-1499		RK-3910-1*		KN-171C**	*w/2-1/4 inch Tall Filter/ **Black=KN-171B
88 CI	FLHRSI Road King Custom F/I	04-06	HD-1499		63-1125*	RC-3680DK	KN-171C**	*Exc. Lower Fairings/ **Black=KN-171B
88 CI	FLHRSI Road King Custom F/I	04-06	HD-1499		63-1125P*	RC-3680DK	KN-171C**	*Exc. Lower Fairings/ **Black=KN-171B
88 CI	FLHRSI Road King Custom F/I	04-06	HD-1499		63-1137*		KN-171C**	*Exc. Lower Fairings/ **Black=KN-171B
88 CI	FLHRSI Road King Custom F/I	04-06	HD-1499		63-1137S*		KN-171C**	*Exc. Lower Fairings/ **Black=KN-171B
88 CI	FLHRSI Road King Custom F/I	04-06	HD-1499		RK-3909-1*		KN-171C**	*w/1-5/8 inch Tall Filter/ **Black=KN-171B
88 CI	FLHRSI Road King Custom F/I	04-06	HD-1499		RK-3910-1*		KN-171C**	*w/2-1/4 inch Tall Filter/ **Black=KN-171B
88 CI	FLHRSI Road King Custom F/I	04-06	HD-1499		RK-3932		KN-171C*	*Black=KN-171B
88 CI	FLHRSI Road King Custom F/I	04-06	HD-1499		RK-3932B		KN-171C*	*Black=KN-171B
88 CI	FLHRSI Road King Custom F/I	04-06	HD-1499		RK-3932X		KN-171C*	*Black=KN-171B
88 CI	FLHRSI Road King Custom F/I	04-06	HD-1499		RK-3932XB		KN-171C*	*Black=KN-171B
88 CI	FLHRSI Road King Custom F/I	04-06	HD-1499		RK-3933	HD-0800DK	KN-171C*	*Black=KN-171B
88 CI	FLHRSI Road King Custom F/I	04-06	HD-1499		RK-3933B	HD-0800DK	KN-171C*	*Black=KN-171B
88 CI	FLHRSI Road King Custom F/I	04-06	HD-1499		RK-3933X		KN-171C*	*Black=KN-171B
88 CI	FLHRSI Road King Custom F/I	04-06	HD-1499		RK-3933XB		KN-171C*	*Black=KN-171B
88 CI	FLHRSI Road King Custom F/I	04-06	HD-1499		RK-3934	RK-3901PK	KN-171C*	*Black=KN-171B
88 CI	FLHRSI Road King Custom F/I	04-06	HD-1499		RK-3935	RK-3902PK	KN-171C*	*Black=KN-171B
88 CI	FLHRSI Road King Custom F/I	04-06	HD-1499		RK-3950*		KN-171C**	*Exc. Lower Fairings/ **Black=KN-171B
88 CI	FLHRSI Road King Custom F/I	04-06	HD-1499		RK-3950S*		KN-171C**	*Exc. Lower Fairings/ **Black=KN-171B
88 CI	FLHT Electra Glide Standard	99-06	HD-1499		RK-3909-1*		KN-171C**	*w/1-5/8 inch Tall Filter/ **Black=KN-171B
88 CI	FLHT Electra Glide Standard	99-06	HD-1499		RK-3910-1*		KN-171C**	*w/2-1/4 inch Tall Filter/ **Black=KN-171B
88 CI	FLHTC Electra Glide Classic	99-05	HD-1499		RK-3909-1*		KN-171C**	*w/1-5/8 inch Tall Filter/ **Black=KN-171B
88 CI	FLHTC Electra Glide Classic	99-05	HD-1499		RK-3910-1*		KN-171C**	*w/2-1/4 inch Tall Filter/ **Black=KN-171B
88 CI	FLHTCI Electra Glide Classic F/I	99-01	HD-8899		RK-3932*		KN-171C**	*w/Delphi Fuel Injection/ **Black=KN-171B
88 CI	FLHTCI Electra Glide Classic F/I	99-01	HD-8899		RK-3932B*		KN-171C**	*w/Delphi Fuel Injection/ **Black=KN-171B
88 CI	FLHTCI Electra Glide Classic F/I	99-01	HD-8899		RK-3932X*		KN-171C**	*w/Delphi Fuel Injection/ **Black=KN-171B
88 CI	FLHTCI Electra Glide Classic F/I	99-01	HD-8899		RK-3932XB*		KN-171C**	*w/Delphi Fuel Injection/ **Black=KN-171B
88 CI	FLHTCI Electra Glide Classic F/I	99-01	HD-8899		RK-3933*	HD-0800DK	KN-171C**	*w/Delphi Fuel Injection/ **Black=KN-171B
88 CI	FLHTCI Electra Glide Classic F/I	99-01	HD-8899		RK-3933B*	HD-0800DK	KN-171C**	*w/Delphi Fuel Injection/ **Black=KN-171B

2) Requires Two; 3) Requires Three; 4) Requires Four. The use of custom air filter requires removal of air box. Some custom filters and intakes are not legal for sale or use on any pollution controlled motor vehicle in California or states adopting California emission procedures. See knfilters.com for CARB status on each part for a specific vehicle.

Motorcycle - Application Listing



CC	Model	Year	Air Filter	Air Filter Precharger	Custom	Custom Precharger	Oil Filter	Comments
HARLEY DAVIDSON								
88 CI	FLHTCI Electra Glide Classic F/I	99-01	HD-8899		RK-3933X*		KN-171C**	*w/Delphi Fuel Injection/ **Black=KN-171B
88 CI	FLHTCI Electra Glide Classic F/I	99-01	HD-8899		RK-3933XB*		KN-171C**	*w/Delphi Fuel Injection/ **Black=KN-171B
88 CI	FLHTCI Electra Glide Classic F/I	99-01	HD-8899		RK-3934*	RK-3901PK	KN-171C**	*w/Delphi Fuel Injection/ **Black=KN-171B
88 CI	FLHTCI Electra Glide Classic F/I	99-01	HD-8899		RK-3935*	RK-3902PK	KN-171C**	*w/Delphi Fuel Injection/ **Black=KN-171B
88 CI	FLHTCI Electra Glide Classic F/I	02-06	HD-1499		63-1125*	RC-3680DK	KN-171C**	*Exc. Lower Fairings/ **Black=KN-171B
88 CI	FLHTCI Electra Glide Classic F/I	02-06	HD-1499		63-1125P*	RC-3680DK	KN-171C**	*Exc. Lower Fairings/ **Black=KN-171B
88 CI	FLHTCI Electra Glide Classic F/I	02-06	HD-1499		63-1137*		KN-171C**	*Exc. Lower Fairings/ **Black=KN-171B
88 CI	FLHTCI Electra Glide Classic F/I	02-06	HD-1499		63-1137S*		KN-171C**	*Exc. Lower Fairings/ **Black=KN-171B
88 CI	FLHTCI Electra Glide Classic F/I	02-06	HD-1499		RK-3909-1*		KN-171C**	*w/1-5/8 inch Tall Filter/ **Black=KN-171B
88 CI	FLHTCI Electra Glide Classic F/I	02-06	HD-1499		RK-3910-1*		KN-171C**	*w/2-1/4 inch Tall Filter/ **Black=KN-171B
88 CI	FLHTCI Electra Glide Classic F/I	02-06	HD-1499		RK-3932		KN-171C*	*Black=KN-171B
88 CI	FLHTCI Electra Glide Classic F/I	02-06	HD-1499		RK-3932B		KN-171C*	*Black=KN-171B
88 CI	FLHTCI Electra Glide Classic F/I	02-06	HD-1499		RK-3932X		KN-171C*	*Black=KN-171B
88 CI	FLHTCI Electra Glide Classic F/I	02-06	HD-1499		RK-3932XB		KN-171C*	*Black=KN-171B
88 CI	FLHTCI Electra Glide Classic F/I	02-06	HD-1499		RK-3933	HD-0800DK	KN-171C*	*Black=KN-171B
88 CI	FLHTCI Electra Glide Classic F/I	02-06	HD-1499		RK-3933B	HD-0800DK	KN-171C*	*Black=KN-171B
88 CI	FLHTCI Electra Glide Classic F/I	02-06	HD-1499		RK-3933X		KN-171C*	*Black=KN-171B
88 CI	FLHTCI Electra Glide Classic F/I	02-06	HD-1499		RK-3933XB		KN-171C*	*Black=KN-171B
88 CI	FLHTCI Electra Glide Classic F/I	02-06	HD-1499		RK-3934	RK-3901PK	KN-171C*	*Black=KN-171B
88 CI	FLHTCI Electra Glide Classic F/I	02-06	HD-1499		RK-3935	RK-3902PK	KN-171C*	*Black=KN-171B
88 CI	FLHTCI Electra Glide Classic F/I	02-06	HD-1499		RK-3950*		KN-171C**	*Exc. Lower Fairings/ **Black=KN-171B
88 CI	FLHTCI Electra Glide Classic F/I	02-06	HD-1499		RK-3950S*		KN-171C**	*Exc. Lower Fairings/ **Black=KN-171B
88 CI	FLHTCI Electra Glide Classic F/I	07	HD-1499				KN-171C*	*Black=KN-171B
88 CI	FLHTCUI Electra Glide Ultra Classic F/I	99-01	HD-8899		RK-3932*		KN-171C**	*w/Delphi Fuel Injection/ **Black=KN-171B
88 CI	FLHTCUI Electra Glide Ultra Classic F/I	99-01	HD-8899		RK-3932B*		KN-171C**	*w/Delphi Fuel Injection/ **Black=KN-171B
88 CI	FLHTCUI Electra Glide Ultra Classic F/I	99-01	HD-8899		RK-3932X*		KN-171C**	*w/Delphi Fuel Injection/ **Black=KN-171B
88 CI	FLHTCUI Electra Glide Ultra Classic F/I	99-01	HD-8899		RK-3932XB*		KN-171C**	*w/Delphi Fuel Injection/ **Black=KN-171B
88 CI	FLHTCUI Electra Glide Ultra Classic F/I	99-01	HD-8899		RK-3933*	HD-0800DK	KN-171C**	*w/Delphi Fuel Injection/ **Black=KN-171B
88 CI	FLHTCUI Electra Glide Ultra Classic F/I	99-01	HD-8899		RK-3933B*	HD-0800DK	KN-171C**	*w/Delphi Fuel Injection/ **Black=KN-171B
88 CI	FLHTCUI Electra Glide Ultra Classic F/I	99-01	HD-8899		RK-3933X*		KN-171C**	*w/Delphi Fuel Injection/ **Black=KN-171B
88 CI	FLHTCUI Electra Glide Ultra Classic F/I	99-01	HD-8899		RK-3933XB*		KN-171C**	*w/Delphi Fuel Injection/ **Black=KN-171B
88 CI	FLHTCUI Electra Glide Ultra Classic F/I	99-01	HD-8899		RK-3934*	RK-3901PK	KN-171C**	*w/Delphi Fuel Injection/ **Black=KN-171B
88 CI	FLHTCUI Electra Glide Ultra Classic F/I	99-01	HD-8899		RK-3935*	RK-3902PK	KN-171C**	*w/Delphi Fuel Injection/ **Black=KN-171B
88 CI	FLHTCUI Electra Glide Ultra Classic F/I	02-06	HD-1499		63-1125*	RC-3680DK	KN-171C**	*Exc. Lower Fairings/ **Black=KN-171B
88 CI	FLHTCUI Electra Glide Ultra Classic F/I	02-06	HD-1499		63-1125P*	RC-3680DK	KN-171C**	*Exc. Lower Fairings/ **Black=KN-171B
88 CI	FLHTCUI Electra Glide Ultra Classic F/I	02-06	HD-1499		63-1137*		KN-171C**	*Exc. Lower Fairings/ **Black=KN-171B

2) Requires Two; 3) Requires Three; 4) Requires Four. The use of custom air filter requires removal of air box. Some custom filters and intakes are not legal for sale or use on any pollution controlled motor vehicle in California or states adopting California emission procedures. See knfilters.com for CARB status on each part for a specific vehicle.



Motorcycle - Application Listing

CC	Model	Year	Air Filter	Air Filter Precharger	Custom	Custom Precharger	Oil Filter	Comments
HARLEY DAVIDSON								
88 CI	FLHTCUI Electra Glide Ultra Classic F/I	02-06	HD-1499		63-1137S*		KN-171C**	*Exc. Lower Fairings/ **Black=KN-171B
88 CI	FLHTCUI Electra Glide Ultra Classic F/I	02-06	HD-1499		RK-3909-1*		KN-171C**	*w/1-5/8 inch Tall Filter/ **Black=KN-171B
88 CI	FLHTCUI Electra Glide Ultra Classic F/I	02-06	HD-1499		RK-3910-1*		KN-171C**	*w/2-1/4 inch Tall Filter/ **Black=KN-171B
88 CI	FLHTCUI Electra Glide Ultra Classic F/I	02-06	HD-1499		RK-3932		KN-171C*	*Black=KN-171B
88 CI	FLHTCUI Electra Glide Ultra Classic F/I	02-06	HD-1499		RK-3932B		KN-171C*	*Black=KN-171B
88 CI	FLHTCUI Electra Glide Ultra Classic F/I	02-06	HD-1499		RK-3932X		KN-171C*	*Black=KN-171B
88 CI	FLHTCUI Electra Glide Ultra Classic F/I	02-06	HD-1499		RK-3932XB		KN-171C*	*Black=KN-171B
88 CI	FLHTCUI Electra Glide Ultra Classic F/I	02-06	HD-1499		RK-3933	HD-0800DK	KN-171C*	*Black=KN-171B
88 CI	FLHTCUI Electra Glide Ultra Classic F/I	02-06	HD-1499		RK-3933B	HD-0800DK	KN-171C*	*Black=KN-171B
88 CI	FLHTCUI Electra Glide Ultra Classic F/I	02-06	HD-1499		RK-3933X		KN-171C*	*Black=KN-171B
88 CI	FLHTCUI Electra Glide Ultra Classic F/I	02-06	HD-1499		RK-3933XB		KN-171C*	*Black=KN-171B
88 CI	FLHTCUI Electra Glide Ultra Classic F/I	02-06	HD-1499		RK-3934	RK-3901PK	KN-171C*	*Black=KN-171B
88 CI	FLHTCUI Electra Glide Ultra Classic F/I	02-06	HD-1499		RK-3935	RK-3902PK	KN-171C*	*Black=KN-171B
88 CI	FLHTCUI Electra Glide Ultra Classic F/I	02-06	HD-1499		RK-3950*		KN-171C**	*Exc. Lower Fairings/ **Black=KN-171B
88 CI	FLHTCUI Electra Glide Ultra Classic F/I	02-06	HD-1499		RK-3950S*		KN-171C**	*Exc. Lower Fairings/ **Black=KN-171B
88 CI	FLHTI Electra Glide Standard F/I	03-06	HD-1499		63-1125*	RC-3680DK	KN-171C**	*Exc. Lower Fairings/ **Black=KN-171B
88 CI	FLHTI Electra Glide Standard F/I	03-06	HD-1499		63-1125P*	RC-3680DK	KN-171C**	*Exc. Lower Fairings/ **Black=KN-171B
88 CI	FLHTI Electra Glide Standard F/I	03-06	HD-1499		63-1137*		KN-171C**	*Exc. Lower Fairings/ **Black=KN-171B
88 CI	FLHTI Electra Glide Standard F/I	03-06	HD-1499		63-1137S*		KN-171C**	*Exc. Lower Fairings/ **Black=KN-171B
88 CI	FLHTI Electra Glide Standard F/I	03-06	HD-1499		RK-3909-1*		KN-171C**	*w/1-5/8 inch Tall Filter/ **Black=KN-171B
88 CI	FLHTI Electra Glide Standard F/I	03-06	HD-1499		RK-3910-1*		KN-171C**	*w/2-1/4 inch Tall Filter/ **Black=KN-171B
88 CI	FLHTI Electra Glide Standard F/I	03-06	HD-1499		RK-3932		KN-171C*	*Black=KN-171B
88 CI	FLHTI Electra Glide Standard F/I	03-06	HD-1499		RK-3932B		KN-171C*	*Black=KN-171B
88 CI	FLHTI Electra Glide Standard F/I	03-06	HD-1499		RK-3932X		KN-171C*	*Black=KN-171B
88 CI	FLHTI Electra Glide Standard F/I	03-06	HD-1499		RK-3932XB		KN-171C*	*Black=KN-171B
88 CI	FLHTI Electra Glide Standard F/I	03-06	HD-1499		RK-3933	HD-0800DK	KN-171C*	*Black=KN-171B
88 CI	FLHTI Electra Glide Standard F/I	03-06	HD-1499		RK-3933B	HD-0800DK	KN-171C*	*Black=KN-171B
88 CI	FLHTI Electra Glide Standard F/I	03-06	HD-1499		RK-3933X		KN-171C*	*Black=KN-171B
88 CI	FLHTI Electra Glide Standard F/I	03-06	HD-1499		RK-3933XB		KN-171C*	*Black=KN-171B
88 CI	FLHTI Electra Glide Standard F/I	03-06	HD-1499		RK-3934	RK-3901PK	KN-171C*	*Black=KN-171B
88 CI	FLHTI Electra Glide Standard F/I	03-06	HD-1499		RK-3935	RK-3902PK	KN-171C*	*Black=KN-171B
88 CI	FLHTI Electra Glide Standard F/I	03-06	HD-1499		RK-3950*		KN-171C**	*Exc. Lower Fairings/ **Black=KN-171B
88 CI	FLHTI Electra Glide Standard F/I	03-06	HD-1499		RK-3950S*		KN-171C**	*Exc. Lower Fairings/ **Black=KN-171B
88 CI	FLHX Street Glide	06	HD-1499		RK-3909-1*		KN-171C**	*w/1-5/8 inch Tall Filter/ **Black=KN-171B
88 CI	FLHX Street Glide	06	HD-1499		RK-3910-1*		KN-171C**	*w/2-1/4 inch Tall Filter/ **Black=KN-171B
88 CI	FLHXI Street Glide F/I	06	HD-1499		63-1125*	RC-3680DK	KN-171C**	*Exc. Lower Fairings/ **Black=KN-171B
88 CI	FLHXI Street Glide F/I	06	HD-1499		63-1125P*	RC-3680DK	KN-171C**	*Exc. Lower Fairings/ **Black=KN-171B
88 CI	FLHXI Street Glide F/I	06	HD-1499		63-1137*		KN-171C**	*Exc. Lower Fairings/ **Black=KN-171B
88 CI	FLHXI Street Glide F/I	06	HD-1499		63-1137S*		KN-171C**	*Exc. Lower Fairings/ **Black=KN-171B
88 CI	FLHXI Street Glide F/I	06	HD-1499		RK-3909-1*		KN-171C**	*w/1-5/8 inch Tall Filter/ **Black=KN-171B

2) Requires Two; 3) Requires Three; 4) Requires Four. The use of custom air filter requires removal of air box. Some custom filters and intakes are not legal for sale or use on any pollution controlled motor vehicle in California or states adopting California emission procedures. See knfilters.com for CARB status on each part for a specific vehicle.

Motorcycle - Application Listing



CC	Model	Year	Air Filter	Air Filter Precharger	Custom	Custom Precharger	Oil Filter	Comments
HARLEY DAVIDSON								
88 CI	FLHXI Street Glide F/I	06	HD-1499		RK-3910-1*		KN-171C**	*w/2-1/4 inch Tall Filter/ **Black=KN-171B
88 CI	FLHXI Street Glide F/I	06	HD-1499		RK-3932		KN-171C*	*Black=KN-171B
88 CI	FLHXI Street Glide F/I	06	HD-1499		RK-3932B		KN-171C*	*Black=KN-171B
88 CI	FLHXI Street Glide F/I	06	HD-1499		RK-3932X		KN-171C*	*Black=KN-171B
88 CI	FLHXI Street Glide F/I	06	HD-1499		RK-3932XB		KN-171C*	*Black=KN-171B
88 CI	FLHXI Street Glide F/I	06	HD-1499		RK-3933	HD-0800DK	KN-171C*	*Black=KN-171B
88 CI	FLHXI Street Glide F/I	06	HD-1499		RK-3933B	HD-0800DK	KN-171C*	*Black=KN-171B
88 CI	FLHXI Street Glide F/I	06	HD-1499		RK-3933X		KN-171C*	*Black=KN-171B
88 CI	FLHXI Street Glide F/I	06	HD-1499		RK-3933XB		KN-171C*	*Black=KN-171B
88 CI	FLHXI Street Glide F/I	06	HD-1499		RK-3934	RK-3901PK	KN-171C*	*Black=KN-171B
88 CI	FLHXI Street Glide F/I	06	HD-1499		RK-3935	RK-3902PK	KN-171C*	*Black=KN-171B
88 CI	FLHXI Street Glide F/I	06	HD-1499		RK-3950*		KN-171C**	*Exc. Lower Fairings/ **Black=KN-171B
88 CI	FLHXI Street Glide F/I	06	HD-1499		RK-3950S*		KN-171C**	*Exc. Lower Fairings/ **Black=KN-171B
88 CI	FLST Heritage Softail	06	HD-1499		RK-3909-1*		KN-171C**	*w/1-5/8 inch Tall Filter/ **Black=KN-171B
88 CI	FLST Heritage Softail	06	HD-1499		RK-3910-1*		KN-171C**	*w/2-1/4 inch Tall Filter/ **Black=KN-171B
88 CI	FLSTC Heritage Softail Classic	00-04	HD-1499		RK-3909-1*		KN-171C**	*w/1-5/8 inch Tall Filter/ **Black=KN-171B
88 CI	FLSTC Heritage Softail Classic	00-04	HD-1499		RK-3910-1*		KN-171C**	*w/2-1/4 inch Tall Filter/ **Black=KN-171B
88 CI	FLSTC Heritage Softail Classic	05-06	HD-1499		RK-3909-1*			*w/1-5/8 inch Tall Filter
88 CI	FLSTC Heritage Softail Classic	05-06	HD-1499		RK-3910-1*			*w/2-1/4 inch Tall Filter
88 CI	FLSTCI Heritage Softail Classic F/I	01	HD-8899		RK-3932		KN-171C*	*Black=KN-171B
88 CI	FLSTCI Heritage Softail Classic F/I	01	HD-8899		RK-3932B		KN-171C*	*Black=KN-171B
88 CI	FLSTCI Heritage Softail Classic F/I	01	HD-8899		RK-3932X		KN-171C*	*Black=KN-171B
88 CI	FLSTCI Heritage Softail Classic F/I	01	HD-8899		RK-3932XB		KN-171C*	*Black=KN-171B
88 CI	FLSTCI Heritage Softail Classic F/I	01	HD-8899		RK-3933	HD-0800DK	KN-171C*	*Black=KN-171B
88 CI	FLSTCI Heritage Softail Classic F/I	01	HD-8899		RK-3933B	HD-0800DK	KN-171C*	*Black=KN-171B
88 CI	FLSTCI Heritage Softail Classic F/I	01	HD-8899		RK-3933X		KN-171C*	*Black=KN-171B
88 CI	FLSTCI Heritage Softail Classic F/I	01	HD-8899		RK-3933XB		KN-171C*	*Black=KN-171B
88 CI	FLSTCI Heritage Softail Classic F/I	01	HD-8899		RK-3934	RK-3901PK	KN-171C*	*Black=KN-171B
88 CI	FLSTCI Heritage Softail Classic F/I	01	HD-8899		RK-3935	RK-3902PK	KN-171C*	*Black=KN-171B
88 CI	FLSTCI Heritage Softail Classic F/I	02-06	HD-1499		63-1125*	RC-3680DK	KN-171C**	*Exc. Lower Fairings/ **Black=KN-171B
88 CI	FLSTCI Heritage Softail Classic F/I	02-06	HD-1499		63-1125P*	RC-3680DK	KN-171C**	*Exc. Lower Fairings/ **Black=KN-171B
88 CI	FLSTCI Heritage Softail Classic F/I	02-06	HD-1499		63-1137*		KN-171C**	*Exc. Lower Fairings/ **Black=KN-171B
88 CI	FLSTCI Heritage Softail Classic F/I	02-06	HD-1499		63-1137S*		KN-171C**	*Exc. Lower Fairings/ **Black=KN-171B
88 CI	FLSTCI Heritage Softail Classic F/I	02-06	HD-1499		RK-3909-1*		KN-171C**	*w/1-5/8 inch Tall Filter/ **Black=KN-171B
88 CI	FLSTCI Heritage Softail Classic F/I	02-06	HD-1499		RK-3910-1*		KN-171C**	*w/2-1/4 inch Tall Filter/ **Black=KN-171B
88 CI	FLSTCI Heritage Softail Classic F/I	02-06	HD-1499		RK-3932		KN-171C*	*Black=KN-171B
88 CI	FLSTCI Heritage Softail Classic F/I	02-06	HD-1499		RK-3932B		KN-171C*	*Black=KN-171B
88 CI	FLSTCI Heritage Softail Classic F/I	02-06	HD-1499		RK-3932X		KN-171C*	*Black=KN-171B
88 CI	FLSTCI Heritage Softail Classic F/I	02-06	HD-1499		RK-3932XB		KN-171C*	*Black=KN-171B
88 CI	FLSTCI Heritage Softail Classic F/I	02-06	HD-1499		RK-3933	HD-0800DK	KN-171C*	*Black=KN-171B
88 CI	FLSTCI Heritage Softail Classic F/I	02-06	HD-1499		RK-3933B	HD-0800DK	KN-171C*	*Black=KN-171B
88 CI	FLSTCI Heritage Softail Classic F/I	02-06	HD-1499		RK-3933X		KN-171C*	*Black=KN-171B
88 CI	FLSTCI Heritage Softail Classic F/I	02-06	HD-1499		RK-3933XB		KN-171C*	*Black=KN-171B
88 CI	FLSTCI Heritage Softail Classic F/I	02-06	HD-1499		RK-3934	RK-3901PK	KN-171C*	*Black=KN-171B
88 CI	FLSTCI Heritage Softail Classic F/I	02-06	HD-1499		RK-3935	RK-3902PK	KN-171C*	*Black=KN-171B

2) Requires Two; 3) Requires Three; 4) Requires Four. The use of custom air filter requires removal of air box. Some custom filters and intakes are not legal for sale or use on any pollution controlled motor vehicle in California or states adopting California emission procedures. See knfilters.com for CARB status on each part for a specific vehicle.



Motorcycle - Application Listing

CC	Model	Year	Air Filter	Air Filter Precharger	Custom	Custom Precharger	Oil Filter	Comments
HARLEY DAVIDSON								
88 CI	FLSTCI Heritage Softail Classic F/I	02-06	HD-1499		RK-3950*		KN-171C**	*Exc. Lower Fairings/ **Black=KN-171B
88 CI	FLSTCI Heritage Softail Classic F/I	02-06	HD-1499		RK-3950S*		KN-171C**	*Exc. Lower Fairings/ **Black=KN-171B
88 CI	FLSTF Fat Boy	00-06	HD-1499		RK-3909-1*		KN-171C**	*w/1-5/8 inch Tall Filter/ **Black=KN-171B
88 CI	FLSTF Fat Boy	00-06	HD-1499		RK-3910-1*		KN-171C**	*w/2-1/4 inch Tall Filter/ **Black=KN-171B
88 CI	FLSTFI Fat Boy F/I	01-06	HD-1499		63-1125*	RC-3680DK	KN-171C**	*Exc. Lower Fairings/ **Black=KN-171B
88 CI	FLSTFI Fat Boy F/I	01-06	HD-1499		63-1125P*	RC-3680DK	KN-171C**	*Exc. Lower Fairings/ **Black=KN-171B
88 CI	FLSTFI Fat Boy F/I	01-06	HD-1499		63-1137*		KN-171C**	*Exc. Lower Fairings/ **Black=KN-171B
88 CI	FLSTFI Fat Boy F/I	01-06	HD-1499		63-1137S*		KN-171C**	*Exc. Lower Fairings/ **Black=KN-171B
88 CI	FLSTFI Fat Boy F/I	01-06	HD-1499		RK-3909-1*		KN-171C**	*w/1-5/8 inch Tall Filter/ **Black=KN-171B
88 CI	FLSTFI Fat Boy F/I	01-06	HD-1499		RK-3910-1*		KN-171C**	*w/2-1/4 inch Tall Filter/ **Black=KN-171B
88 CI	FLSTFI Fat Boy F/I	01-06	HD-1499		RK-3932		KN-171C*	*Black=KN-171B
88 CI	FLSTFI Fat Boy F/I	01-06	HD-1499		RK-3932B		KN-171C*	*Black=KN-171B
88 CI	FLSTFI Fat Boy F/I	01-06	HD-1499		RK-3932X		KN-171C*	*Black=KN-171B
88 CI	FLSTFI Fat Boy F/I	01-06	HD-1499		RK-3932XB		KN-171C*	*Black=KN-171B
88 CI	FLSTFI Fat Boy F/I	01-06	HD-1499		RK-3933	HD-0800DK	KN-171C*	*Black=KN-171B
88 CI	FLSTFI Fat Boy F/I	01-06	HD-1499		RK-3933B	HD-0800DK	KN-171C*	*Black=KN-171B
88 CI	FLSTFI Fat Boy F/I	01-06	HD-1499		RK-3933X		KN-171C*	*Black=KN-171B
88 CI	FLSTFI Fat Boy F/I	01-06	HD-1499		RK-3933XB		KN-171C*	*Black=KN-171B
88 CI	FLSTFI Fat Boy F/I	01-06	HD-1499		RK-3934	RK-3901PK	KN-171C*	*Black=KN-171B
88 CI	FLSTFI Fat Boy F/I	01-06	HD-1499		RK-3935	RK-3902PK	KN-171C*	*Black=KN-171B
88 CI	FLSTFI Fat Boy F/I	01-06	HD-1499		RK-3950*		KN-171C**	*Exc. Lower Fairings/ **Black=KN-171B
88 CI	FLSTFI Fat Boy F/I	01-06	HD-1499		RK-3950S*		KN-171C**	*Exc. Lower Fairings/ **Black=KN-171B
88 CI	FLSTI Heritage Softail F/I	06	HD-1499		63-1125*	RC-3680DK	KN-171C**	*Exc. Lower Fairings/ **Black=KN-171B
88 CI	FLSTI Heritage Softail F/I	06	HD-1499		63-1125P*	RC-3680DK	KN-171C**	*Exc. Lower Fairings/ **Black=KN-171B
88 CI	FLSTI Heritage Softail F/I	06	HD-1499		63-1137*		KN-171C**	*Exc. Lower Fairings/ **Black=KN-171B
88 CI	FLSTI Heritage Softail F/I	06	HD-1499		63-1137S*		KN-171C**	*Exc. Lower Fairings/ **Black=KN-171B
88 CI	FLSTI Heritage Softail F/I	06	HD-1499		RK-3909-1*		KN-171C**	*w/1-5/8 inch Tall Filter/ **Black=KN-171B
88 CI	FLSTI Heritage Softail F/I	06	HD-1499		RK-3910-1*		KN-171C**	*w/2-1/4 inch Tall Filter/ **Black=KN-171B
88 CI	FLSTI Heritage Softail F/I	06	HD-1499		RK-3932		KN-171C*	*Black=KN-171B
88 CI	FLSTI Heritage Softail F/I	06	HD-1499		RK-3932B		KN-171C*	*Black=KN-171B
88 CI	FLSTI Heritage Softail F/I	06	HD-1499		RK-3932X		KN-171C*	*Black=KN-171B
88 CI	FLSTI Heritage Softail F/I	06	HD-1499		RK-3932XB		KN-171C*	*Black=KN-171B
88 CI	FLSTI Heritage Softail F/I	06	HD-1499		RK-3933	HD-0800DK	KN-171C*	*Black=KN-171B
88 CI	FLSTI Heritage Softail F/I	06	HD-1499		RK-3933B	HD-0800DK	KN-171C*	*Black=KN-171B
88 CI	FLSTI Heritage Softail F/I	06	HD-1499		RK-3933X		KN-171C*	*Black=KN-171B
88 CI	FLSTI Heritage Softail F/I	06	HD-1499		RK-3933XB		KN-171C*	*Black=KN-171B
88 CI	FLSTI Heritage Softail F/I	06	HD-1499		RK-3934	RK-3901PK	KN-171C*	*Black=KN-171B
88 CI	FLSTI Heritage Softail F/I	06	HD-1499		RK-3935	RK-3902PK	KN-171C*	*Black=KN-171B
88 CI	FLSTI Heritage Softail F/I	06	HD-1499		RK-3950*		KN-171C**	*Exc. Lower Fairings/ **Black=KN-171B
88 CI	FLSTI Heritage Softail F/I	06	HD-1499		RK-3950S*		KN-171C**	*Exc. Lower Fairings/ **Black=KN-171B

2) Requires Two; 3) Requires Three; 4) Requires Four. The use of custom air filter requires removal of air box. Some custom filters and intakes are not legal for sale or use on any pollution controlled motor vehicle in California or states adopting California emission procedures. See knfilters.com for CARB status on each part for a specific vehicle.

Motorcycle - Application Listing



CC	Model	Year	Air Filter	Air Filter Precharger	Custom	Custom Precharger	Oil Filter	Comments
HARLEY DAVIDSON								
88 CI	FLSTN Softail Deluxe	05-06	HD-1499		RK-3909-1*		KN-171C**	*w/1-5/8 inch Tall Filter/ **Black=KN-171B
88 CI	FLSTN Softail Deluxe	05-06	HD-1499		RK-3910-1*		KN-171C**	*w/2-1/4 inch Tall Filter/ **Black=KN-171B
88 CI	FLSTNI Softail Deluxe F/I	05-06	HD-1499		63-1125*	RC-3680DK	KN-171C**	*Exc. Lower Fairings/ **Black=KN-171B
88 CI	FLSTNI Softail Deluxe F/I	05-06	HD-1499		63-1125P*	RC-3680DK	KN-171C**	*Exc. Lower Fairings/ **Black=KN-171B
88 CI	FLSTNI Softail Deluxe F/I	05-06	HD-1499		63-1137*		KN-171C**	*Exc. Lower Fairings/ **Black=KN-171B
88 CI	FLSTNI Softail Deluxe F/I	05-06	HD-1499		63-1137S*		KN-171C**	*Exc. Lower Fairings/ **Black=KN-171B
88 CI	FLSTNI Softail Deluxe F/I	05-06	HD-1499		RK-3909-1*		KN-171C**	*w/1-5/8 inch Tall Filter/ **Black=KN-171B
88 CI	FLSTNI Softail Deluxe F/I	05-06	HD-1499		RK-3910-1*		KN-171C**	*w/2-1/4 inch Tall Filter/ **Black=KN-171B
88 CI	FLSTNI Softail Deluxe F/I	05-06	HD-1499		RK-3932		KN-171C*	*Black=KN-171B
88 CI	FLSTNI Softail Deluxe F/I	05-06	HD-1499		RK-3932B		KN-171C*	*Black=KN-171B
88 CI	FLSTNI Softail Deluxe F/I	05-06	HD-1499		RK-3932X		KN-171C*	*Black=KN-171B
88 CI	FLSTNI Softail Deluxe F/I	05-06	HD-1499		RK-3932XB		KN-171C*	*Black=KN-171B
88 CI	FLSTNI Softail Deluxe F/I	05-06	HD-1499		RK-3933	HD-0800DK	KN-171C*	*Black=KN-171B
88 CI	FLSTNI Softail Deluxe F/I	05-06	HD-1499		RK-3933B	HD-0800DK	KN-171C*	*Black=KN-171B
88 CI	FLSTNI Softail Deluxe F/I	05-06	HD-1499		RK-3933X		KN-171C*	*Black=KN-171B
88 CI	FLSTNI Softail Deluxe F/I	05-06	HD-1499		RK-3933XB		KN-171C*	*Black=KN-171B
88 CI	FLSTNI Softail Deluxe F/I	05-06	HD-1499		RK-3934	RK-3901PK	KN-171C*	*Black=KN-171B
88 CI	FLSTNI Softail Deluxe F/I	05-06	HD-1499		RK-3935	RK-3902PK	KN-171C*	*Black=KN-171B
88 CI	FLSTNI Softail Deluxe F/I	05-06	HD-1499		RK-3950*		KN-171C**	*Exc. Lower Fairings/ **Black=KN-171B
88 CI	FLSTNI Softail Deluxe F/I	05-06	HD-1499		RK-3950S*		KN-171C**	*Exc. Lower Fairings/ **Black=KN-171B
88 CI	FLSTS Heritage Springer	00-03	HD-1499		RK-3909-1*		KN-171C**	*w/1-5/8 inch Tall Filter/ **Black=KN-171B
88 CI	FLSTS Heritage Springer	00-03	HD-1499		RK-3910-1*		KN-171C**	*w/2-1/4 inch Tall Filter/ **Black=KN-171B
88 CI	FLSTSC Softail Springer Classic	05-06	HD-1499		RK-3909-1*		KN-171C**	*w/1-5/8 inch Tall Filter/ **Black=KN-171B
88 CI	FLSTSC Softail Springer Classic	05-06	HD-1499		RK-3910-1*		KN-171C**	*w/2-1/4 inch Tall Filter/ **Black=KN-171B
88 CI	FLSTSCI Softail Springer Classic F/I	05-06	HD-1499		63-1125*	RC-3680DK	KN-171C**	*Exc. Lower Fairings/ **Black=KN-171B
88 CI	FLSTSCI Softail Springer Classic F/I	05-06	HD-1499		63-1125P*	RC-3680DK	KN-171C**	*Exc. Lower Fairings/ **Black=KN-171B
88 CI	FLSTSCI Softail Springer Classic F/I	05-06	HD-1499		63-1137*		KN-171C**	*Exc. Lower Fairings/ **Black=KN-171B
88 CI	FLSTSCI Softail Springer Classic F/I	05-06	HD-1499		63-1137S*		KN-171C**	*Exc. Lower Fairings/ **Black=KN-171B
88 CI	FLSTSCI Softail Springer Classic F/I	05-06	HD-1499		RK-3909-1*		KN-171C**	*w/1-5/8 inch Tall Filter/ **Black=KN-171B
88 CI	FLSTSCI Softail Springer Classic F/I	05-06	HD-1499		RK-3910-1*		KN-171C**	*w/2-1/4 inch Tall Filter/ **Black=KN-171B
88 CI	FLSTSCI Softail Springer Classic F/I	05-06	HD-1499		RK-3932		KN-171C*	*Black=KN-171B
88 CI	FLSTSCI Softail Springer Classic F/I	05-06	HD-1499		RK-3932B		KN-171C*	*Black=KN-171B
88 CI	FLSTSCI Softail Springer Classic F/I	05-06	HD-1499		RK-3932X		KN-171C*	*Black=KN-171B
88 CI	FLSTSCI Softail Springer Classic F/I	05-06	HD-1499		RK-3932XB		KN-171C*	*Black=KN-171B
88 CI	FLSTSCI Softail Springer Classic F/I	05-06	HD-1499		RK-3933	HD-0800DK	KN-171C*	*Black=KN-171B
88 CI	FLSTSCI Softail Springer Classic F/I	05-06	HD-1499		RK-3933B	HD-0800DK	KN-171C*	*Black=KN-171B
88 CI	FLSTSCI Softail Springer Classic F/I	05-06	HD-1499		RK-3933X		KN-171C*	*Black=KN-171B
88 CI	FLSTSCI Softail Springer Classic F/I	05-06	HD-1499		RK-3933XB		KN-171C*	*Black=KN-171B
88 CI	FLSTSCI Softail Springer Classic F/I	05-06	HD-1499		RK-3934	RK-3901PK	KN-171C*	*Black=KN-171B
88 CI	FLSTSCI Softail Springer Classic F/I	05-06	HD-1499		RK-3935	RK-3902PK	KN-171C*	*Black=KN-171B

2) Requires Two; 3) Requires Three; 4) Requires Four. The use of custom air filter requires removal of air box. Some custom filters and intakes are not legal for sale or use on any pollution controlled motor vehicle in California or states adopting California emission procedures. See knfilters.com for CARB status on each part for a specific vehicle.



Motorcycle - Application Listing

CC	Model	Year	Air Filter	Air Filter Precharger	Custom	Custom Precharger	Oil Filter	Comments
HARLEY DAVIDSON								
88 CI	FLSTSCI Softail Springer Classic F/I	05-06	HD-1499		RK-3950*		KN-171C**	*Exc. Lower Fairings/ **Black=KN-171B
88 CI	FLSTSCI Softail Springer Classic F/I	05-06	HD-1499		RK-3950S*		KN-171C**	*Exc. Lower Fairings/ **Black=KN-171B
88 CI	FLSTSI Heritage Springer F/I	01-03	HD-1499		63-1125*	RC-3680DK	KN-171C**	*Exc. Lower Fairings/ **Black=KN-171B
88 CI	FLSTSI Heritage Springer F/I	01-03	HD-1499		63-1125P*	RC-3680DK	KN-171C**	*Exc. Lower Fairings/ **Black=KN-171B
88 CI	FLSTSI Heritage Springer F/I	01-03	HD-1499		63-1137*		KN-171C**	*Exc. Lower Fairings/ **Black=KN-171B
88 CI	FLSTSI Heritage Springer F/I	01-03	HD-1499		63-1137S*		KN-171C**	*Exc. Lower Fairings/ **Black=KN-171B
88 CI	FLSTSI Heritage Springer F/I	01-03	HD-1499		RK-3909-1*		KN-171C**	*w/1-5/8 inch Tall Filter/ **Black=KN-171B
88 CI	FLSTSI Heritage Springer F/I	01-03	HD-1499		RK-3910-1*		KN-171C**	*w/2-1/4 inch Tall Filter/ **Black=KN-171B
88 CI	FLSTSI Heritage Springer F/I	01-03	HD-1499		RK-3932		KN-171C*	*Black=KN-171B
88 CI	FLSTSI Heritage Springer F/I	01-03	HD-1499		RK-3932B		KN-171C*	*Black=KN-171B
88 CI	FLSTSI Heritage Springer F/I	01-03	HD-1499		RK-3932X		KN-171C*	*Black=KN-171B
88 CI	FLSTSI Heritage Springer F/I	01-03	HD-1499		RK-3932XB		KN-171C*	*Black=KN-171B
88 CI	FLSTSI Heritage Springer F/I	01-03	HD-1499		RK-3933	HD-0800DK	KN-171C*	*Black=KN-171B
88 CI	FLSTSI Heritage Springer F/I	01-03	HD-1499		RK-3933B	HD-0800DK	KN-171C*	*Black=KN-171B
88 CI	FLSTSI Heritage Springer F/I	01-03	HD-1499		RK-3933X		KN-171C*	*Black=KN-171B
88 CI	FLSTSI Heritage Springer F/I	01-03	HD-1499		RK-3933XB		KN-171C*	*Black=KN-171B
88 CI	FLSTSI Heritage Springer F/I	01-03	HD-1499		RK-3934	RK-3901PK	KN-171C*	*Black=KN-171B
88 CI	FLSTSI Heritage Springer F/I	01-03	HD-1499		RK-3935	RK-3902PK	KN-171C*	*Black=KN-171B
88 CI	FLSTSI Heritage Springer F/I	01-03	HD-1499		RK-3950*		KN-171C**	*Exc. Lower Fairings/ **Black=KN-171B
88 CI	FLSTSI Heritage Springer F/I	01-03	HD-1499		RK-3950S*		KN-171C**	*Exc. Lower Fairings/ **Black=KN-171B
88 CI	FLTR Road Glide	99-02	HD-1499		RK-3909-1*		KN-171C**	*w/1-5/8 inch Tall Filter/ **Black=KN-171B
88 CI	FLTR Road Glide	99-02	HD-1499		RK-3910-1*		KN-171C**	*w/2-1/4 inch Tall Filter/ **Black=KN-171B
88 CI	FLTR Road Glide	03-06					KN-171C*	*Black=KN-171B
88 CI	FLTRI Road Glide F/I	99-01	HD-8899		RK-3932*		KN-171C**	*w/Delphi Fuel Injection/ **Black=KN-171B
88 CI	FLTRI Road Glide F/I	99-01	HD-8899		RK-3932B*		KN-171C**	*w/Delphi Fuel Injection/ **Black=KN-171B
88 CI	FLTRI Road Glide F/I	99-01	HD-8899		RK-3932X*		KN-171C**	*w/Delphi Fuel Injection/ **Black=KN-171B
88 CI	FLTRI Road Glide F/I	99-01	HD-8899		RK-3932XB*		KN-171C**	*w/Delphi Fuel Injection/ **Black=KN-171B
88 CI	FLTRI Road Glide F/I	99-01	HD-8899		RK-3933*	HD-0800DK	KN-171C**	*w/Delphi Fuel Injection/ **Black=KN-171B
88 CI	FLTRI Road Glide F/I	99-01	HD-8899		RK-3933B*	HD-0800DK	KN-171C**	*w/Delphi Fuel Injection/ **Black=KN-171B
88 CI	FLTRI Road Glide F/I	99-01	HD-8899		RK-3933X*		KN-171C**	*w/Delphi Fuel Injection/ **Black=KN-171B
88 CI	FLTRI Road Glide F/I	99-01	HD-8899		RK-3933XB*		KN-171C**	*w/Delphi Fuel Injection/ **Black=KN-171B
88 CI	FLTRI Road Glide F/I	99-01	HD-8899		RK-3934*	RK-3901PK	KN-171C**	*w/Delphi Fuel Injection/ **Black=KN-171B
88 CI	FLTRI Road Glide F/I	99-01	HD-8899		RK-3935*	RK-3902PK	KN-171C**	*w/Delphi Fuel Injection/ **Black=KN-171B
88 CI	FLTRI Road Glide F/I	02-06	HD-1499		63-1125*	RC-3680DK	KN-171C**	*Exc. Lower Fairings/ **Black=KN-171B
88 CI	FLTRI Road Glide F/I	02-06	HD-1499		63-1125P*	RC-3680DK	KN-171C**	*Exc. Lower Fairings/ **Black=KN-171B
88 CI	FLTRI Road Glide F/I	02-06	HD-1499		63-1137*		KN-171C**	*Exc. Lower Fairings/ **Black=KN-171B

2) Requires Two; 3) Requires Three; 4) Requires Four. The use of custom air filter requires removal of air box. Some custom filters and intakes are not legal for sale or use on any pollution controlled motor vehicle in California or states adopting California emission procedures. See knfilters.com for CARB status on each part for a specific vehicle.

Motorcycle - Application Listing



CC	Model	Year	Air Filter	Air Filter Precharger	Custom	Custom Precharger	Oil Filter	Comments
HARLEY DAVIDSON								
88 CI	FLTRI Road Glide F/I	02-06	HD-1499		63-1137S*		KN-171C**	*Exc. Lower Fairings/ **Black=KN-171B
88 CI	FLTRI Road Glide F/I	02-06	HD-1499		RK-3909-1*		KN-171C**	*w/1-5/8 inch Tall Filter/ **Black=KN-171B
88 CI	FLTRI Road Glide F/I	02-06	HD-1499		RK-3910-1*		KN-171C**	*w/2-1/4 inch Tall Filter/ **Black=KN-171B
88 CI	FLTRI Road Glide F/I	02-06	HD-1499		RK-3932		KN-171C*	*Black=KN-171B
88 CI	FLTRI Road Glide F/I	02-06	HD-1499		RK-3932B		KN-171C*	*Black=KN-171B
88 CI	FLTRI Road Glide F/I	02-06	HD-1499		RK-3932X		KN-171C*	*Black=KN-171B
88 CI	FLTRI Road Glide F/I	02-06	HD-1499		RK-3932XB		KN-171C*	*Black=KN-171B
88 CI	FLTRI Road Glide F/I	02-06	HD-1499		RK-3933	HD-0800DK	KN-171C*	*Black=KN-171B
88 CI	FLTRI Road Glide F/I	02-06	HD-1499		RK-3933B	HD-0800DK	KN-171C*	*Black=KN-171B
88 CI	FLTRI Road Glide F/I	02-06	HD-1499		RK-3933X		KN-171C*	*Black=KN-171B
88 CI	FLTRI Road Glide F/I	02-06	HD-1499		RK-3933XB		KN-171C*	*Black=KN-171B
88 CI	FLTRI Road Glide F/I	02-06	HD-1499		RK-3934	RK-3901PK	KN-171C*	*Black=KN-171B
88 CI	FLTRI Road Glide F/I	02-06	HD-1499		RK-3935	RK-3902PK	KN-171C*	*Black=KN-171B
88 CI	FLTRI Road Glide F/I	02-06	HD-1499		RK-3950*		KN-171C**	*Exc. Lower Fairings/ **Black=KN-171B
88 CI	FLTRI Road Glide F/I	02-06	HD-1499		RK-3950S*		KN-171C**	*Exc. Lower Fairings/ **Black=KN-171B
88 CI	FXD Dyna Super Glide	99-03	HD-1499		RK-3909-1*		KN-171C**	*w/1-5/8 inch Tall Filter/ **Black=KN-171B
88 CI	FXD Dyna Super Glide	99-03	HD-1499		RK-3910-1*		KN-171C**	*w/2-1/4 inch Tall Filter/ **Black=KN-171B
88 CI	FXD Dyna Super Glide	04-05	HD-1499		RK-3909-1*			*w/1-5/8 inch Tall Filter
88 CI	FXD Dyna Super Glide	04-05	HD-1499		RK-3910-1*			*w/2-1/4 inch Tall Filter
88 CI	FXD Dyna Super Glide	06			RK-3909-1*			*w/1-5/8 inch Tall Filter
88 CI	FXD Dyna Super Glide	06			RK-3910-1*			*w/2-1/4 inch Tall Filter
88 CI	FXDBI Street Bob F/I	06	HD-1499		63-1125*	RC-3680DK	KN-171C**	*Exc. Lower Fairings/ **Black=KN-171B
88 CI	FXDBI Street Bob F/I	06	HD-1499		63-1125P*	RC-3680DK	KN-171C**	*Exc. Lower Fairings/ **Black=KN-171B
88 CI	FXDBI Street Bob F/I	06	HD-1499		63-1137*		KN-171C**	*Exc. Lower Fairings/ **Black=KN-171B
88 CI	FXDBI Street Bob F/I	06	HD-1499		63-1137S*		KN-171C**	*Exc. Lower Fairings/ **Black=KN-171B
88 CI	FXDBI Street Bob F/I	06	HD-1499		RK-3909-1*		KN-171C**	*w/1-5/8 inch Tall Filter/ **Black=KN-171B
88 CI	FXDBI Street Bob F/I	06	HD-1499		RK-3910-1*		KN-171C**	*w/2-1/4 inch Tall Filter/ **Black=KN-171B
88 CI	FXDBI Street Bob F/I	06	HD-1499		RK-3932		KN-171C*	*Black=KN-171B
88 CI	FXDBI Street Bob F/I	06	HD-1499		RK-3932B		KN-171C*	*Black=KN-171B
88 CI	FXDBI Street Bob F/I	06	HD-1499		RK-3932X		KN-171C*	*Black=KN-171B
88 CI	FXDBI Street Bob F/I	06	HD-1499		RK-3932XB		KN-171C*	*Black=KN-171B
88 CI	FXDBI Street Bob F/I	06	HD-1499		RK-3933	HD-0800DK	KN-171C*	*Black=KN-171B
88 CI	FXDBI Street Bob F/I	06	HD-1499		RK-3933B	HD-0800DK	KN-171C*	*Black=KN-171B
88 CI	FXDBI Street Bob F/I	06	HD-1499		RK-3933X		KN-171C*	*Black=KN-171B
88 CI	FXDBI Street Bob F/I	06	HD-1499		RK-3933XB		KN-171C*	*Black=KN-171B
88 CI	FXDBI Street Bob F/I	06	HD-1499		RK-3934	RK-3901PK	KN-171C*	*Black=KN-171B
88 CI	FXDBI Street Bob F/I	06	HD-1499		RK-3935	RK-3902PK	KN-171C*	*Black=KN-171B
88 CI	FXDBI Street Bob F/I	06	HD-1499		RK-3950*		KN-171C**	*Exc. Lower Fairings/ **Black=KN-171B
88 CI	FXDBI Street Bob F/I	06	HD-1499		RK-3950S*		KN-171C**	*Exc. Lower Fairings/ **Black=KN-171B
88 CI	FXDC Dyna Super Glide Custom	05-06			RK-3909-1*			*w/1-5/8 inch Tall Filter
88 CI	FXDC Dyna Super Glide Custom	05-06			RK-3910-1*			*w/2-1/4 inch Tall Filter
88 CI	FXDCI Dyna Super Glide Custom F/I	05-06	HD-1499		63-1125*	RC-3680DK	KN-171C**	*Exc. Lower Fairings/ **Black=KN-171B
88 CI	FXDCI Dyna Super Glide Custom F/I	05-06	HD-1499		63-1125P*	RC-3680DK	KN-171C**	*Exc. Lower Fairings/ **Black=KN-171B

2) Requires Two; 3) Requires Three; 4) Requires Four. The use of custom air filter requires removal of air box. Some custom filters and intakes are not legal for sale or use on any pollution controlled motor vehicle in California or states adopting California emission procedures. See knfilters.com for CARB status on each part for a specific vehicle.



Motorcycle - Application Listing

CC	Model	Year	Air Filter	Air Filter Precharger	Custom	Custom Precharger	Oil Filter	Comments
HARLEY DAVIDSON								
88 CI	FXDCI Dyna Super Glide Custom F/I	05-06	HD-1499		63-1137*		KN-171C**	*Exc. Lower Fairings/ **Black=KN-171B
88 CI	FXDCI Dyna Super Glide Custom F/I	05-06	HD-1499		63-1137S*		KN-171C**	*Exc. Lower Fairings/ **Black=KN-171B
88 CI	FXDCI Dyna Super Glide Custom F/I	05-06	HD-1499		RK-3909-1*		KN-171C**	*w/1-5/8 inch Tall Filter/ **Black=KN-171B
88 CI	FXDCI Dyna Super Glide Custom F/I	05-06	HD-1499		RK-3910-1*		KN-171C**	*w/2-1/4 inch Tall Filter/ **Black=KN-171B
88 CI	FXDCI Dyna Super Glide Custom F/I	05-06	HD-1499		RK-3932		KN-171C*	*Black=KN-171B
88 CI	FXDCI Dyna Super Glide Custom F/I	05-06	HD-1499		RK-3932B		KN-171C*	*Black=KN-171B
88 CI	FXDCI Dyna Super Glide Custom F/I	05-06	HD-1499		RK-3932X		KN-171C*	*Black=KN-171B
88 CI	FXDCI Dyna Super Glide Custom F/I	05-06	HD-1499		RK-3932XB		KN-171C*	*Black=KN-171B
88 CI	FXDCI Dyna Super Glide Custom F/I	05-06	HD-1499		RK-3933	HD-0800DK	KN-171C*	*Black=KN-171B
88 CI	FXDCI Dyna Super Glide Custom F/I	05-06	HD-1499		RK-3933B	HD-0800DK	KN-171C*	*Black=KN-171B
88 CI	FXDCI Dyna Super Glide Custom F/I	05-06	HD-1499		RK-3933X		KN-171C*	*Black=KN-171B
88 CI	FXDCI Dyna Super Glide Custom F/I	05-06	HD-1499		RK-3933XB		KN-171C*	*Black=KN-171B
88 CI	FXDCI Dyna Super Glide Custom F/I	05-06	HD-1499		RK-3934	RK-3901PK	KN-171C*	*Black=KN-171B
88 CI	FXDCI Dyna Super Glide Custom F/I	05-06	HD-1499		RK-3935	RK-3902PK	KN-171C*	*Black=KN-171B
88 CI	FXDCI Dyna Super Glide Custom F/I	05-06	HD-1499		RK-3950*		KN-171C**	*Exc. Lower Fairings/ **Black=KN-171B
88 CI	FXDCI Dyna Super Glide Custom F/I	05-06	HD-1499		RK-3950S*		KN-171C**	*Exc. Lower Fairings/ **Black=KN-171B
88 CI	FXDI Dyna Super Glide F/I	04-06	HD-1499		63-1125*	RC-3680DK	KN-171C**	*Exc. Lower Fairings/ **Black=KN-171B
88 CI	FXDI Dyna Super Glide F/I	04-06	HD-1499		63-1125P*	RC-3680DK	KN-171C**	*Exc. Lower Fairings/ **Black=KN-171B
88 CI	FXDI Dyna Super Glide F/I	04-06	HD-1499		63-1137*		KN-171C**	*Exc. Lower Fairings/ **Black=KN-171B
88 CI	FXDI Dyna Super Glide F/I	04-06	HD-1499		63-1137S*		KN-171C**	*Exc. Lower Fairings/ **Black=KN-171B
88 CI	FXDI Dyna Super Glide F/I	04-06	HD-1499		RK-3909-1*		KN-171C**	*w/1-5/8 inch Tall Filter/ **Black=KN-171B
88 CI	FXDI Dyna Super Glide F/I	04-06	HD-1499		RK-3910-1*		KN-171C**	*w/2-1/4 inch Tall Filter/ **Black=KN-171B
88 CI	FXDI Dyna Super Glide F/I	04-06	HD-1499		RK-3932		KN-171C*	*Black=KN-171B
88 CI	FXDI Dyna Super Glide F/I	04-06	HD-1499		RK-3932B		KN-171C*	*Black=KN-171B
88 CI	FXDI Dyna Super Glide F/I	04-06	HD-1499		RK-3932X		KN-171C*	*Black=KN-171B
88 CI	FXDI Dyna Super Glide F/I	04-06	HD-1499		RK-3932XB		KN-171C*	*Black=KN-171B
88 CI	FXDI Dyna Super Glide F/I	04-06	HD-1499		RK-3933	HD-0800DK	KN-171C*	*Black=KN-171B
88 CI	FXDI Dyna Super Glide F/I	04-06	HD-1499		RK-3933B	HD-0800DK	KN-171C*	*Black=KN-171B
88 CI	FXDI Dyna Super Glide F/I	04-06	HD-1499		RK-3933X		KN-171C*	*Black=KN-171B
88 CI	FXDI Dyna Super Glide F/I	04-06	HD-1499		RK-3933XB		KN-171C*	*Black=KN-171B
88 CI	FXDI Dyna Super Glide F/I	04-06	HD-1499		RK-3934	RK-3901PK	KN-171C*	*Black=KN-171B
88 CI	FXDI Dyna Super Glide F/I	04-06	HD-1499		RK-3935	RK-3902PK	KN-171C*	*Black=KN-171B
88 CI	FXDI Dyna Super Glide F/I	04-06	HD-1499		RK-3950*		KN-171C**	*Exc. Lower Fairings/ **Black=KN-171B
88 CI	FXDI Dyna Super Glide F/I	04-06	HD-1499		RK-3950S*		KN-171C**	*Exc. Lower Fairings/ **Black=KN-171B
88 CI	FXDI35 35th Anniv. Super Glide F/I	06	HD-1499		63-1125*	RC-3680DK	KN-171C**	*Exc. Lower Fairings/ **Black=KN-171B
88 CI	FXDI35 35th Anniv. Super Glide F/I	06	HD-1499		63-1125P*	RC-3680DK	KN-171C**	*Exc. Lower Fairings/ **Black=KN-171B
88 CI	FXDI35 35th Anniv. Super Glide F/I	06	HD-1499		63-1137*		KN-171C**	*Exc. Lower Fairings/ **Black=KN-171B
88 CI	FXDI35 35th Anniv. Super Glide F/I	06	HD-1499		63-1137S*		KN-171C**	*Exc. Lower Fairings/ **Black=KN-171B
88 CI	FXDI35 35th Anniv. Super Glide F/I	06	HD-1499		RK-3909-1*		KN-171C**	*w/1-5/8 inch Tall Filter/ **Black=KN-171B
88 CI	FXDI35 35th Anniv. Super Glide F/I	06	HD-1499		RK-3910-1*		KN-171C**	*w/2-1/4 inch Tall Filter/ **Black=KN-171B
88 CI	FXDI35 35th Anniv. Super Glide F/I	06	HD-1499		RK-3932		KN-171C*	*Black=KN-171B

2) Requires Two; 3) Requires Three; 4) Requires Four. The use of custom air filter requires removal of air box. Some custom filters and intakes are not legal for sale or use on any pollution controlled motor vehicle in California or states adopting California emission procedures. See knfilters.com for CARB status on each part for a specific vehicle.

Motorcycle - Application Listing



CC	Model	Year	Air Filter	Air Filter Precharger	Custom	Custom Precharger	Oil Filter	Comments
HARLEY DAVIDSON								
88 CI	FXDI35 35th Anniv. Super Glide F/I	06	HD-1499		RK-3932B		KN-171C*	*Black=KN-171B
88 CI	FXDI35 35th Anniv. Super Glide F/I	06	HD-1499		RK-3932X		KN-171C*	*Black=KN-171B
88 CI	FXDI35 35th Anniv. Super Glide F/I	06	HD-1499		RK-3932XB		KN-171C*	*Black=KN-171B
88 CI	FXDI35 35th Anniv. Super Glide F/I	06	HD-1499		RK-3933	HD-0800DK	KN-171C*	*Black=KN-171B
88 CI	FXDI35 35th Anniv. Super Glide F/I	06	HD-1499		RK-3933B	HD-0800DK	KN-171C*	*Black=KN-171B
88 CI	FXDI35 35th Anniv. Super Glide F/I	06	HD-1499		RK-3933X		KN-171C*	*Black=KN-171B
88 CI	FXDI35 35th Anniv. Super Glide F/I	06	HD-1499		RK-3933XB		KN-171C*	*Black=KN-171B
88 CI	FXDI35 35th Anniv. Super Glide F/I	06	HD-1499		RK-3934	RK-3901PK	KN-171C*	*Black=KN-171B
88 CI	FXDI35 35th Anniv. Super Glide F/I	06	HD-1499		RK-3935	RK-3902PK	KN-171C*	*Black=KN-171B
88 CI	FXDI35 35th Anniv. Super Glide F/I	06	HD-1499		RK-3950*		KN-171C**	*Exc. Lower Fairings/ **Black=KN-171B
88 CI	FXDI35 35th Anniv. Super Glide F/I	06	HD-1499		RK-3950S*		KN-171C**	*Exc. Lower Fairings/ **Black=KN-171B
88 CI	FXDL Dyna Low Rider	99-06	HD-1499		RK-3909-1*		KN-171C**	*w/1-5/8 inch Tall Filter/ **Black=KN-171B
88 CI	FXDL Dyna Low Rider	99-06	HD-1499		RK-3910-1*		KN-171C**	*w/2-1/4 inch Tall Filter/ **Black=KN-171B
88 CI	FXDLI Dyna Low Rider F/I	04-06	HD-1499		63-1125*	RC-3680DK	KN-171C**	*Exc. Lower Fairings/ **Black=KN-171B
88 CI	FXDLI Dyna Low Rider F/I	04-06	HD-1499		63-1125P*	RC-3680DK	KN-171C**	*Exc. Lower Fairings/ **Black=KN-171B
88 CI	FXDLI Dyna Low Rider F/I	04-06	HD-1499		63-1137*		KN-171C**	*Exc. Lower Fairings/ **Black=KN-171B
88 CI	FXDLI Dyna Low Rider F/I	04-06	HD-1499		63-1137S*		KN-171C**	*Exc. Lower Fairings/ **Black=KN-171B
88 CI	FXDLI Dyna Low Rider F/I	04-06	HD-1499		RK-3909-1*		KN-171C**	*w/1-5/8 inch Tall Filter/ **Black=KN-171B
88 CI	FXDLI Dyna Low Rider F/I	04-06	HD-1499		RK-3910-1*		KN-171C**	*w/2-1/4 inch Tall Filter/ **Black=KN-171B
88 CI	FXDLI Dyna Low Rider F/I	04-06	HD-1499		RK-3932		KN-171C*	*Black=KN-171B
88 CI	FXDLI Dyna Low Rider F/I	04-06	HD-1499		RK-3932B		KN-171C*	*Black=KN-171B
88 CI	FXDLI Dyna Low Rider F/I	04-06	HD-1499		RK-3932X		KN-171C*	*Black=KN-171B
88 CI	FXDLI Dyna Low Rider F/I	04-06	HD-1499		RK-3932XB		KN-171C*	*Black=KN-171B
88 CI	FXDLI Dyna Low Rider F/I	04-06	HD-1499		RK-3933	HD-0800DK	KN-171C*	*Black=KN-171B
88 CI	FXDLI Dyna Low Rider F/I	04-06	HD-1499		RK-3933B	HD-0800DK	KN-171C*	*Black=KN-171B
88 CI	FXDLI Dyna Low Rider F/I	04-06	HD-1499		RK-3933X		KN-171C*	*Black=KN-171B
88 CI	FXDLI Dyna Low Rider F/I	04-06	HD-1499		RK-3933XB		KN-171C*	*Black=KN-171B
88 CI	FXDLI Dyna Low Rider F/I	04-06	HD-1499		RK-3934	RK-3901PK	KN-171C*	*Black=KN-171B
88 CI	FXDLI Dyna Low Rider F/I	04-06	HD-1499		RK-3935	RK-3902PK	KN-171C*	*Black=KN-171B
88 CI	FXDLI Dyna Low Rider F/I	04-06	HD-1499		RK-3950*		KN-171C**	*Exc. Lower Fairings/ **Black=KN-171B
88 CI	FXDLI Dyna Low Rider F/I	04-06	HD-1499		RK-3950S*		KN-171C**	*Exc. Lower Fairings/ **Black=KN-171B
88 CI	FXDS Dyna Convertible	99-00	HD-1499		RK-3909-1*		KN-171C**	*w/1-5/8 inch Tall Filter/ **Black=KN-171B
88 CI	FXDS Dyna Convertible	99-00	HD-1499		RK-3910-1*		KN-171C**	*w/2-1/4 inch Tall Filter/ **Black=KN-171B
88 CI	FXDWG Dyna Wide Glide	99-06	HD-1499		RK-3909-1*		KN-171C**	*w/1-5/8 inch Tall Filter/ **Black=KN-171B
88 CI	FXDWG Dyna Wide Glide	99-06	HD-1499		RK-3910-1*		KN-171C**	*w/2-1/4 inch Tall Filter/ **Black=KN-171B
88 CI	FXDWG2	00	HD-1499		RK-3909-1*		KN-171C**	*w/1-5/8 inch Tall Filter/ **Black=KN-171B
88 CI	FXDWG2	00	HD-1499		RK-3910-1*		KN-171C**	*w/2-1/4 inch Tall Filter/ **Black=KN-171B
88 CI	FXDWG3	01	HD-1499		RK-3909-1*		KN-171C**	*w/1-5/8 inch Tall Filter/ **Black=KN-171B
88 CI	FXDWG3	01	HD-1499		RK-3910-1*		KN-171C**	*w/2-1/4 inch Tall Filter/ **Black=KN-171B
88 CI	FXDWGI Dyna Wide Glide F/I	04-06	HD-1499		63-1125*	RC-3680DK	KN-171C**	*Exc. Lower Fairings/ **Black=KN-171B

2) Requires Two; 3) Requires Three; 4) Requires Four. The use of custom air filter requires removal of air box. Some custom filters and intakes are not legal for sale or use on any pollution controlled motor vehicle in California or states adopting California emission procedures. See knfilters.com for CARB status on each part for a specific vehicle.



Motorcycle - Application Listing

CC	Model	Year	Air Filter	Air Filter Precharger	Custom	Custom Precharger	Oil Filter	Comments
HARLEY DAVIDSON								
88 CI	FXDWGI Dyna Wide Glide F/I	04-06	HD-1499		63-1125P*	RC-3680DK	KN-171C**	*Exc. Lower Fairings/ **Black=KN-171B
88 CI	FXDWGI Dyna Wide Glide F/I	04-06	HD-1499		63-1137*		KN-171C**	*Exc. Lower Fairings/ **Black=KN-171B
88 CI	FXDWGI Dyna Wide Glide F/I	04-06	HD-1499		63-1137S*		KN-171C**	*Exc. Lower Fairings/ **Black=KN-171B
88 CI	FXDWGI Dyna Wide Glide F/I	04-06	HD-1499		RK-3909-1*		KN-171C**	*w/1-5/8 inch Tall Filter/ **Black=KN-171B
88 CI	FXDWGI Dyna Wide Glide F/I	04-06	HD-1499		RK-3910-1*		KN-171C**	*w/2-1/4 inch Tall Filter/ **Black=KN-171B
88 CI	FXDWGI Dyna Wide Glide F/I	04-06	HD-1499		RK-3932		KN-171C*	*Black=KN-171B
88 CI	FXDWGI Dyna Wide Glide F/I	04-06	HD-1499		RK-3932B		KN-171C*	*Black=KN-171B
88 CI	FXDWGI Dyna Wide Glide F/I	04-06	HD-1499		RK-3932X		KN-171C*	*Black=KN-171B
88 CI	FXDWGI Dyna Wide Glide F/I	04-06	HD-1499		RK-3932XB		KN-171C*	*Black=KN-171B
88 CI	FXDWGI Dyna Wide Glide F/I	04-06	HD-1499		RK-3933	HD-0800DK	KN-171C*	*Black=KN-171B
88 CI	FXDWGI Dyna Wide Glide F/I	04-06	HD-1499		RK-3933B	HD-0800DK	KN-171C*	*Black=KN-171B
88 CI	FXDWGI Dyna Wide Glide F/I	04-06	HD-1499		RK-3933X		KN-171C*	*Black=KN-171B
88 CI	FXDWGI Dyna Wide Glide F/I	04-06	HD-1499		RK-3933XB		KN-171C*	*Black=KN-171B
88 CI	FXDWGI Dyna Wide Glide F/I	04-06	HD-1499		RK-3934	RK-3901PK	KN-171C*	*Black=KN-171B
88 CI	FXDWGI Dyna Wide Glide F/I	04-06	HD-1499		RK-3935	RK-3902PK	KN-171C*	*Black=KN-171B
88 CI	FXDWGI Dyna Wide Glide F/I	04-06	HD-1499		RK-3950*		KN-171C**	*Exc. Lower Fairings/ **Black=KN-171B
88 CI	FXDWGI Dyna Wide Glide F/I	04-06	HD-1499		RK-3950S*		KN-171C**	*Exc. Lower Fairings/ **Black=KN-171B
88 CI	FXDX Dyna Super Glide Sport	99-04	HD-1499		RK-3909-1*		KN-171C**	*w/1-5/8 inch Tall Filter/ **Black=KN-171B
88 CI	FXDX Dyna Super Glide Sport	99-04	HD-1499		RK-3910-1*		KN-171C**	*w/2-1/4 inch Tall Filter/ **Black=KN-171B
88 CI	FXDXI Dyna Super Glide Sport F/I	04-05	HD-1499		63-1125*	RC-3680DK	KN-171C**	*Exc. Lower Fairings/ **Black=KN-171B
88 CI	FXDXI Dyna Super Glide Sport F/I	04-05	HD-1499		63-1125P*	RC-3680DK	KN-171C**	*Exc. Lower Fairings/ **Black=KN-171B
88 CI	FXDXI Dyna Super Glide Sport F/I	04-05	HD-1499		63-1137*		KN-171C**	*Exc. Lower Fairings/ **Black=KN-171B
88 CI	FXDXI Dyna Super Glide Sport F/I	04-05	HD-1499		63-1137S*		KN-171C**	*Exc. Lower Fairings/ **Black=KN-171B
88 CI	FXDXI Dyna Super Glide Sport F/I	04-05	HD-1499		RK-3909-1*		KN-171C**	*w/1-5/8 inch Tall Filter/ **Black=KN-171B
88 CI	FXDXI Dyna Super Glide Sport F/I	04-05	HD-1499		RK-3910-1*		KN-171C**	*w/2-1/4 inch Tall Filter/ **Black=KN-171B
88 CI	FXDXI Dyna Super Glide Sport F/I	04-05	HD-1499		RK-3932		KN-171C*	*Black=KN-171B
88 CI	FXDXI Dyna Super Glide Sport F/I	04-05	HD-1499		RK-3932B		KN-171C*	*Black=KN-171B
88 CI	FXDXI Dyna Super Glide Sport F/I	04-05	HD-1499		RK-3932X		KN-171C*	*Black=KN-171B
88 CI	FXDXI Dyna Super Glide Sport F/I	04-05	HD-1499		RK-3932XB		KN-171C*	*Black=KN-171B
88 CI	FXDXI Dyna Super Glide Sport F/I	04-05	HD-1499		RK-3933	HD-0800DK	KN-171C*	*Black=KN-171B
88 CI	FXDXI Dyna Super Glide Sport F/I	04-05	HD-1499		RK-3933B	HD-0800DK	KN-171C*	*Black=KN-171B
88 CI	FXDXI Dyna Super Glide Sport F/I	04-05	HD-1499		RK-3933X		KN-171C*	*Black=KN-171B
88 CI	FXDXI Dyna Super Glide Sport F/I	04-05	HD-1499		RK-3933XB		KN-171C*	*Black=KN-171B
88 CI	FXDXI Dyna Super Glide Sport F/I	04-05	HD-1499		RK-3934	RK-3901PK	KN-171C*	*Black=KN-171B
88 CI	FXDXI Dyna Super Glide Sport F/I	04-05	HD-1499		RK-3935	RK-3902PK	KN-171C*	*Black=KN-171B
88 CI	FXDXI Dyna Super Glide Sport F/I	04-05	HD-1499		RK-3950*		KN-171C**	*Exc. Lower Fairings/ **Black=KN-171B
88 CI	FXDXI Dyna Super Glide Sport F/I	04-05	HD-1499		RK-3950S*		KN-171C**	*Exc. Lower Fairings/ **Black=KN-171B
88 CI	FXDXT Dyna Super Glide T-Sport	01-03	HD-1499		RK-3909-1*		KN-171C**	*w/1-5/8 inch Tall Filter/ **Black=KN-171B
88 CI	FXDXT Dyna Super Glide T-Sport	01-03	HD-1499		RK-3910-1*		KN-171C**	*w/2-1/4 inch Tall Filter/ **Black=KN-171B
88 CI	FXST Softail Standard	00-06	HD-1499		RK-3909-1*		KN-171C**	*w/1-5/8 inch Tall Filter/ **Black=KN-171B

2) Requires Two; 3) Requires Three; 4) Requires Four. The use of custom air filter requires removal of air box. Some custom filters and intakes are not legal for sale or use on any pollution controlled motor vehicle in California or states adopting California emission procedures. See knfilters.com for CARB status on each part for a specific vehicle.

Motorcycle - Application Listing



CC	Model	Year	Air Filter	Air Filter Precharger	Custom	Custom Precharger	Oil Filter	Comments
HARLEY DAVIDSON								
88 CI	FXST Softail Standard	00-06	HD-1499		RK-3910-1*		KN-171C**	*w/2-1/4 inch Tall Filter/ **Black=KN-171B
88 CI	FXSTB Night Train	00-06	HD-1499		RK-3909-1*		KN-171C**	*w/1-5/8 inch Tall Filter/ **Black=KN-171B
88 CI	FXSTB Night Train	00-06	HD-1499		RK-3910-1*		KN-171C**	*w/2-1/4 inch Tall Filter/ **Black=KN-171B
88 CI	FXSTBI Night Train F/I	01-06	HD-1499		63-1125*	RC-3680DK	KN-171C**	*Exc. Lower Fairings/ **Black=KN-171B
88 CI	FXSTBI Night Train F/I	01-06	HD-1499		63-1125P*	RC-3680DK	KN-171C**	*Exc. Lower Fairings/ **Black=KN-171B
88 CI	FXSTBI Night Train F/I	01-06	HD-1499		63-1137*		KN-171C**	*Exc. Lower Fairings/ **Black=KN-171B
88 CI	FXSTBI Night Train F/I	01-06	HD-1499		63-1137S*		KN-171C**	*Exc. Lower Fairings/ **Black=KN-171B
88 CI	FXSTBI Night Train F/I	01-06	HD-1499		RK-3909-1*		KN-171C**	*w/1-5/8 inch Tall Filter/ **Black=KN-171B
88 CI	FXSTBI Night Train F/I	01-06	HD-1499		RK-3910-1*		KN-171C**	*w/2-1/4 inch Tall Filter/ **Black=KN-171B
88 CI	FXSTBI Night Train F/I	01-06	HD-1499		RK-3932		KN-171C*	*Black=KN-171B
88 CI	FXSTBI Night Train F/I	01-06	HD-1499		RK-3932B		KN-171C*	*Black=KN-171B
88 CI	FXSTBI Night Train F/I	01-06	HD-1499		RK-3932X		KN-171C*	*Black=KN-171B
88 CI	FXSTBI Night Train F/I	01-06	HD-1499		RK-3932XB		KN-171C*	*Black=KN-171B
88 CI	FXSTBI Night Train F/I	01-06	HD-1499		RK-3933	HD-0800DK	KN-171C*	*Black=KN-171B
88 CI	FXSTBI Night Train F/I	01-06	HD-1499		RK-3933B	HD-0800DK	KN-171C*	*Black=KN-171B
88 CI	FXSTBI Night Train F/I	01-06	HD-1499		RK-3933X		KN-171C*	*Black=KN-171B
88 CI	FXSTBI Night Train F/I	01-06	HD-1499		RK-3933XB		KN-171C*	*Black=KN-171B
88 CI	FXSTBI Night Train F/I	01-06	HD-1499		RK-3934	RK-3901PK	KN-171C*	*Black=KN-171B
88 CI	FXSTBI Night Train F/I	01-06	HD-1499		RK-3935	RK-3902PK	KN-171C*	*Black=KN-171B
88 CI	FXSTBI Night Train F/I	01-06	HD-1499		RK-3950*		KN-171C**	*Exc. Lower Fairings/ **Black=KN-171B
88 CI	FXSTBI Night Train F/I	01-06	HD-1499		RK-3950S*		KN-171C**	*Exc. Lower Fairings/ **Black=KN-171B
88 CI	FXSTD Softail Deuce	00-06	HD-1499		RK-3909-1*		KN-171C**	*w/1-5/8 inch Tall Filter/ **Black=KN-171B
88 CI	FXSTD Softail Deuce	00-06	HD-1499		RK-3910-1*		KN-171C**	*w/2-1/4 inch Tall Filter/ **Black=KN-171B
88 CI	FXSTDI Softail Deuce F/I	01-06	HD-1499		63-1125*	RC-3680DK	KN-171C**	*Exc. Lower Fairings/ **Black=KN-171B
88 CI	FXSTDI Softail Deuce F/I	01-06	HD-1499		63-1125P*	RC-3680DK	KN-171C**	*Exc. Lower Fairings/ **Black=KN-171B
88 CI	FXSTDI Softail Deuce F/I	01-06	HD-1499		63-1137*		KN-171C**	*Exc. Lower Fairings/ **Black=KN-171B
88 CI	FXSTDI Softail Deuce F/I	01-06	HD-1499		63-1137S*		KN-171C**	*Exc. Lower Fairings/ **Black=KN-171B
88 CI	FXSTDI Softail Deuce F/I	01-06	HD-1499		RK-3909-1*		KN-171C**	*w/1-5/8 inch Tall Filter/ **Black=KN-171B
88 CI	FXSTDI Softail Deuce F/I	01-06	HD-1499		RK-3910-1*		KN-171C**	*w/2-1/4 inch Tall Filter/ **Black=KN-171B
88 CI	FXSTDI Softail Deuce F/I	01-06	HD-1499		RK-3932		KN-171C*	*Black=KN-171B
88 CI	FXSTDI Softail Deuce F/I	01-06	HD-1499		RK-3932B		KN-171C*	*Black=KN-171B
88 CI	FXSTDI Softail Deuce F/I	01-06	HD-1499		RK-3932X		KN-171C*	*Black=KN-171B
88 CI	FXSTDI Softail Deuce F/I	01-06	HD-1499		RK-3932XB		KN-171C*	*Black=KN-171B
88 CI	FXSTDI Softail Deuce F/I	01-06	HD-1499		RK-3933	HD-0800DK	KN-171C*	*Black=KN-171B
88 CI	FXSTDI Softail Deuce F/I	01-06	HD-1499		RK-3933B	HD-0800DK	KN-171C*	*Black=KN-171B
88 CI	FXSTDI Softail Deuce F/I	01-06	HD-1499		RK-3933X		KN-171C*	*Black=KN-171B
88 CI	FXSTDI Softail Deuce F/I	01-06	HD-1499		RK-3933XB		KN-171C*	*Black=KN-171B
88 CI	FXSTDI Softail Deuce F/I	01-06	HD-1499		RK-3934	RK-3901PK	KN-171C*	*Black=KN-171B
88 CI	FXSTDI Softail Deuce F/I	01-06	HD-1499		RK-3935	RK-3902PK	KN-171C*	*Black=KN-171B
88 CI	FXSTDI Softail Deuce F/I	01-06	HD-1499		RK-3950*		KN-171C**	*Exc. Lower Fairings/ **Black=KN-171B

2) Requires Two; 3) Requires Three; 4) Requires Four. The use of custom air filter requires removal of air box. Some custom filters and intakes are not legal for sale or use on any pollution controlled motor vehicle in California or states adopting California emission procedures. See knfilters.com for CARB status on each part for a specific vehicle.



Motorcycle - Application Listing

CC	Model	Year	Air Filter	Air Filter Precharger	Custom	Custom Precharger	Oil Filter	Comments
HARLEY DAVIDSON								
88 CI	FXSTDI Softail Deuce F/I	01-06	HD-1499		RK-3950S*		KN-171C**	*Exc. Lower Fairings/ **Black=KN-171B
88 CI	FXSTI Softail Standard F/I	01-06	HD-1499		63-1125*	RC-3680DK	KN-171C**	*Exc. Lower Fairings/ **Black=KN-171B
88 CI	FXSTI Softail Standard F/I	01-06	HD-1499		63-1125P*	RC-3680DK	KN-171C**	*Exc. Lower Fairings/ **Black=KN-171B
88 CI	FXSTI Softail Standard F/I	01-06	HD-1499		63-1137*		KN-171C**	*Exc. Lower Fairings/ **Black=KN-171B
88 CI	FXSTI Softail Standard F/I	01-06	HD-1499		63-1137S*		KN-171C**	*Exc. Lower Fairings/ **Black=KN-171B
88 CI	FXSTI Softail Standard F/I	01-06	HD-1499		RK-3909-1*		KN-171C**	*w/1-5/8 inch Tall Filter/ **Black=KN-171B
88 CI	FXSTI Softail Standard F/I	01-06	HD-1499		RK-3910-1*		KN-171C**	*w/2-1/4 inch Tall Filter/ **Black=KN-171B
88 CI	FXSTI Softail Standard F/I	01-06	HD-1499		RK-3932		KN-171C*	*Black=KN-171B
88 CI	FXSTI Softail Standard F/I	01-06	HD-1499		RK-3932B		KN-171C*	*Black=KN-171B
88 CI	FXSTI Softail Standard F/I	01-06	HD-1499		RK-3932X		KN-171C*	*Black=KN-171B
88 CI	FXSTI Softail Standard F/I	01-06	HD-1499		RK-3932XB		KN-171C*	*Black=KN-171B
88 CI	FXSTI Softail Standard F/I	01-06	HD-1499		RK-3933	HD-0800DK	KN-171C*	*Black=KN-171B
88 CI	FXSTI Softail Standard F/I	01-06	HD-1499		RK-3933B	HD-0800DK	KN-171C*	*Black=KN-171B
88 CI	FXSTI Softail Standard F/I	01-06	HD-1499		RK-3933X		KN-171C*	*Black=KN-171B
88 CI	FXSTI Softail Standard F/I	01-06	HD-1499		RK-3933XB		KN-171C*	*Black=KN-171B
88 CI	FXSTI Softail Standard F/I	01-06	HD-1499		RK-3934	RK-3901PK	KN-171C*	*Black=KN-171B
88 CI	FXSTI Softail Standard F/I	01-06	HD-1499		RK-3935	RK-3902PK	KN-171C*	*Black=KN-171B
88 CI	FXSTI Softail Standard F/I	01-06	HD-1499		RK-3950*		KN-171C**	*Exc. Lower Fairings/ **Black=KN-171B
88 CI	FXSTI Softail Standard F/I	01-06	HD-1499		RK-3950S*		KN-171C**	*Exc. Lower Fairings/ **Black=KN-171B
88 CI	FXSTS Springer Softail	00-06	HD-1499		RK-3909-1*		KN-171C**	*w/1-5/8 inch Tall Filter/ **Black=KN-171B
88 CI	FXSTS Springer Softail	00-06	HD-1499		RK-3910-1*		KN-171C**	*w/2-1/4 inch Tall Filter/ **Black=KN-171B
88 CI	FXSTSI Springer Softail F/I	01-06	HD-1499		63-1125*	RC-3680DK	KN-171C**	*Exc. Lower Fairings/ **Black=KN-171B
88 CI	FXSTSI Springer Softail F/I	01-06	HD-1499		63-1125P*	RC-3680DK	KN-171C**	*Exc. Lower Fairings/ **Black=KN-171B
88 CI	FXSTSI Springer Softail F/I	01-06	HD-1499		63-1137*		KN-171C**	*Exc. Lower Fairings/ **Black=KN-171B
88 CI	FXSTSI Springer Softail F/I	01-06	HD-1499		63-1137S*		KN-171C**	*Exc. Lower Fairings/ **Black=KN-171B
88 CI	FXSTSI Springer Softail F/I	01-06	HD-1499		RK-3909-1*		KN-171C**	*w/1-5/8 inch Tall Filter/ **Black=KN-171B
88 CI	FXSTSI Springer Softail F/I	01-06	HD-1499		RK-3910-1*		KN-171C**	*w/2-1/4 inch Tall Filter/ **Black=KN-171B
88 CI	FXSTSI Springer Softail F/I	01-06	HD-1499		RK-3932		KN-171C*	*Black=KN-171B
88 CI	FXSTSI Springer Softail F/I	01-06	HD-1499		RK-3932B		KN-171C*	*Black=KN-171B
88 CI	FXSTSI Springer Softail F/I	01-06	HD-1499		RK-3932X		KN-171C*	*Black=KN-171B
88 CI	FXSTSI Springer Softail F/I	01-06	HD-1499		RK-3932XB		KN-171C*	*Black=KN-171B
88 CI	FXSTSI Springer Softail F/I	01-06	HD-1499		RK-3933	HD-0800DK	KN-171C*	*Black=KN-171B
88 CI	FXSTSI Springer Softail F/I	01-06	HD-1499		RK-3933B	HD-0800DK	KN-171C*	*Black=KN-171B
88 CI	FXSTSI Springer Softail F/I	01-06	HD-1499		RK-3933X		KN-171C*	*Black=KN-171B
88 CI	FXSTSI Springer Softail F/I	01-06	HD-1499		RK-3933XB		KN-171C*	*Black=KN-171B
88 CI	FXSTSI Springer Softail F/I	01-06	HD-1499		RK-3934	RK-3901PK	KN-171C*	*Black=KN-171B
88 CI	FXSTSI Springer Softail F/I	01-06	HD-1499		RK-3935	RK-3902PK	KN-171C*	*Black=KN-171B
88 CI	FXSTSI Springer Softail F/I	01-06	HD-1499		RK-3950*		KN-171C**	*Exc. Lower Fairings/ **Black=KN-171B
88 CI	FXSTSI Springer Softail F/I	01-06	HD-1499		RK-3950S*		KN-171C**	*Exc. Lower Fairings/ **Black=KN-171B
95 CI	FLSTFI Fat Boy F/I 15th Anniv.	05	HD-0800	HD-0800DK			KN-171C*	*Black=KN-171B
95 CI	FLTRSEI2 Screamin Eagle Road Glide 2 F/I	01	HD-0800	HD-0800DK			KN-171C*	*Black=KN-171B
95 CI	FXSTDSE Screamin Eagle Softail Deuce	03					KN-171C*	*Black=KN-171B

2) Requires Two; 3) Requires Three; 4) Requires Four. The use of custom air filter requires removal of air box. Some custom filters and intakes are not legal for sale or use on any pollution controlled motor vehicle in California or states adopting California emission procedures. See knfilters.com for CARB status on each part for a specific vehicle.

Motorcycle - Application Listing



CC	Model	Year	Air Filter	Air Filter Precharger	Custom	Custom Precharger	Oil Filter	Comments
HARLEY DAVIDSON								
95 CI	FXSTDSE2 Screamin Eagle Softail Duce 2	04					KN-171C*	*Black=KN-171B
96 CI	FLHR Road King	07	HD-1499		63-1125*	RC-3680DK	KN-171C**	*Exc. Lower Fairings/ **Black=KN-171B
96 CI	FLHR Road King	07	HD-1499		63-1125P*	RC-3680DK	KN-171C**	*Exc. Lower Fairings/ **Black=KN-171B
96 CI	FLHR Road King	07	HD-1499		63-1137*		KN-171C**	*Exc. Lower Fairings/ **Black=KN-171B
96 CI	FLHR Road King	07	HD-1499		63-1137S*		KN-171C**	*Exc. Lower Fairings/ **Black=KN-171B
96 CI	FLHR Road King	07	HD-1499		RK-3909-1*		KN-171C**	*w/1-5/8 inch Tall Filter/ **Black=KN-171B
96 CI	FLHR Road King	07	HD-1499		RK-3910-1*		KN-171C**	*w/2-1/4 inch Tall Filter/ **Black=KN-171B
96 CI	FLHR Road King	07	HD-1499		RK-3932		KN-171C*	*Black=KN-171B
96 CI	FLHR Road King	07	HD-1499		RK-3932B		KN-171C*	*Black=KN-171B
96 CI	FLHR Road King	07	HD-1499		RK-3932X		KN-171C*	*Black=KN-171B
96 CI	FLHR Road King	07	HD-1499		RK-3932XB		KN-171C*	*Black=KN-171B
96 CI	FLHR Road King	07	HD-1499		RK-3933	HD-0800DK	KN-171C*	*Black=KN-171B
96 CI	FLHR Road King	07	HD-1499		RK-3933B	HD-0800DK	KN-171C*	*Black=KN-171B
96 CI	FLHR Road King	07	HD-1499		RK-3933X		KN-171C*	*Black=KN-171B
96 CI	FLHR Road King	07	HD-1499		RK-3933XB		KN-171C*	*Black=KN-171B
96 CI	FLHR Road King	07	HD-1499		RK-3934	RK-3901PK	KN-171C*	*Black=KN-171B
96 CI	FLHR Road King	07	HD-1499		RK-3935	RK-3902PK	KN-171C*	*Black=KN-171B
96 CI	FLHR Road King	07	HD-1499		RK-3950*		KN-171C**	*Exc. Lower Fairings/ **Black=KN-171B
96 CI	FLHR Road King	07	HD-1499		RK-3950S*		KN-171C**	*Exc. Lower Fairings/ **Black=KN-171B
96 CI	FLHR Road King	08-11	HD-1508		63-1122*	RC-3680DK	KN-171C**	*Exc. Lower Fairings/ **Black=KN-171B
96 CI	FLHR Road King	08-11	HD-1508		63-1122P*	RC-3680DK	KN-171C**	*Exc. Lower Fairings/ **Black=KN-171B
96 CI	FLHR Road King	08-11	HD-1508		63-1131*		KN-171C**	*w/Lower Fairings/ **Black=KN-171B
96 CI	FLHR Road King	08-11	HD-1508		63-1131P*		KN-171C**	*w/Lower Fairings/ **Black=KN-171B
96 CI	FLHR Road King	08-11	HD-1508		63-1134*		KN-171C**	*Exc. Lower Fairings/ **Black=KN-171B
96 CI	FLHR Road King	08-11	HD-1508		63-1134S*		KN-171C**	*Exc. Lower Fairings/ **Black=KN-171B
96 CI	FLHR Road King	08-11	HD-1508		RK-3930		KN-171C*	*Black=KN-171B
96 CI	FLHR Road King	08-11	HD-1508		RK-3930X		KN-171C*	*Black=KN-171B
96 CI	FLHR Road King	08-11	HD-1508		RK-3936	RK-3901PK	KN-171C*	*Black=KN-171B
96 CI	FLHR Road King	08-11	HD-1508		RK-3937	RK-3902PK	KN-171C*	*Black=KN-171B
96 CI	FLHR Road King	08-11	HD-1508		RK-3938	RK-3901PK	KN-171C*	*Black=KN-171B
96 CI	FLHR Road King	08-11	HD-1508		RK-3939	RK-3902PK	KN-171C*	*Black=KN-171B
96 CI	FLHR Road King	08-11	HD-1508		RK-3946	HD-0800DK	KN-171C*	*Black=KN-171B
96 CI	FLHR Road King	08-11	HD-1508		RK-3946B	HD-0800DK	KN-171C*	*Black=KN-171B
96 CI	FLHR Road King	08-11	HD-1508		RK-3946X		KN-171C*	*Black=KN-171B
96 CI	FLHR Road King	08-11	HD-1508		RK-3946XB		KN-171C*	*Black=KN-171B
96 CI	FLHR Road King	08-11	HD-1508		RK-3947		KN-171C*	*Black=KN-171B
96 CI	FLHR Road King	08-11	HD-1508		RK-3947B		KN-171C*	*Black=KN-171B
96 CI	FLHR Road King	08-11	HD-1508		RK-3947X		KN-171C*	*Black=KN-171B
96 CI	FLHR Road King	08-11	HD-1508		RK-3947XB		KN-171C*	*Black=KN-171B
96 CI	FLHR Road King	08-11	HD-1508		RK-3951*		KN-171C**	*Exc. Lower Fairings/ **Black=KN-171B
96 CI	FLHR Road King	08-11	HD-1508		RK-3951S*		KN-171C**	*Exc. Lower Fairings/ **Black=KN-171B
96 CI	FLHRC Road King Classic	07	HD-1499		63-1125*	RC-3680DK	KN-171C**	*Exc. Lower Fairings/ **Black=KN-171B

2) Requires Two; 3) Requires Three; 4) Requires Four. The use of custom air filter requires removal of air box. Some custom filters and intakes are not legal for sale or use on any pollution controlled motor vehicle in California or states adopting California emission procedures. See knfilters.com for CARB status on each part for a specific vehicle.



Motorcycle - Application Listing

CC	Model	Year	Air Filter	Air Filter Precharger	Custom	Custom Precharger	Oil Filter	Comments
HARLEY DAVIDSON								
96 CI	FLHRC Road King Classic	07	HD-1499		63-1125P*	RC-3680DK	KN-171C**	*Exc. Lower Fairings/ **Black=KN-171B
96 CI	FLHRC Road King Classic	07	HD-1499		63-1137*		KN-171C**	*Exc. Lower Fairings/ **Black=KN-171B
96 CI	FLHRC Road King Classic	07	HD-1499		63-1137S*		KN-171C**	*Exc. Lower Fairings/ **Black=KN-171B
96 CI	FLHRC Road King Classic	07	HD-1499		RK-3909-1*		KN-171C**	*w/1-5/8 inch Tall Filter/ **Black=KN-171B
96 CI	FLHRC Road King Classic	07	HD-1499		RK-3910-1*		KN-171C**	*w/2-1/4 inch Tall Filter/ **Black=KN-171B
96 CI	FLHRC Road King Classic	07	HD-1499		RK-3932		KN-171C*	*Black=KN-171B
96 CI	FLHRC Road King Classic	07	HD-1499		RK-3932B		KN-171C*	*Black=KN-171B
96 CI	FLHRC Road King Classic	07	HD-1499		RK-3932X		KN-171C*	*Black=KN-171B
96 CI	FLHRC Road King Classic	07	HD-1499		RK-3932XB		KN-171C*	*Black=KN-171B
96 CI	FLHRC Road King Classic	07	HD-1499		RK-3933	HD-0800DK	KN-171C*	*Black=KN-171B
96 CI	FLHRC Road King Classic	07	HD-1499		RK-3933B	HD-0800DK	KN-171C*	*Black=KN-171B
96 CI	FLHRC Road King Classic	07	HD-1499		RK-3933X		KN-171C*	*Black=KN-171B
96 CI	FLHRC Road King Classic	07	HD-1499		RK-3933XB		KN-171C*	*Black=KN-171B
96 CI	FLHRC Road King Classic	07	HD-1499		RK-3934	RK-3901PK	KN-171C*	*Black=KN-171B
96 CI	FLHRC Road King Classic	07	HD-1499		RK-3935	RK-3902PK	KN-171C*	*Black=KN-171B
96 CI	FLHRC Road King Classic	07	HD-1499		RK-3950*		KN-171C**	*Exc. Lower Fairings/ **Black=KN-171B
96 CI	FLHRC Road King Classic	07	HD-1499		RK-3950S*		KN-171C**	*Exc. Lower Fairings/ **Black=KN-171B
96 CI	FLHRC Road King Classic	08-10	HD-1508		63-1122*	RC-3680DK	KN-171C**	*Exc. Lower Fairings/ **Black=KN-171B
96 CI	FLHRC Road King Classic	08-10	HD-1508		63-1122P*	RC-3680DK	KN-171C**	*Exc. Lower Fairings/ **Black=KN-171B
96 CI	FLHRC Road King Classic	08-10	HD-1508		63-1131*		KN-171C**	*w/Lower Fairings/ **Black=KN-171B
96 CI	FLHRC Road King Classic	08-10	HD-1508		63-1131P*		KN-171C**	*w/Lower Fairings/ **Black=KN-171B
96 CI	FLHRC Road King Classic	08-10	HD-1508		63-1134*		KN-171C**	*Exc. Lower Fairings/ **Black=KN-171B
96 CI	FLHRC Road King Classic	08-10	HD-1508		63-1134S*		KN-171C**	*Exc. Lower Fairings/ **Black=KN-171B
96 CI	FLHRC Road King Classic	08-10	HD-1508		RK-3930		KN-171C*	*Black=KN-171B
96 CI	FLHRC Road King Classic	08-10	HD-1508		RK-3930X		KN-171C*	*Black=KN-171B
96 CI	FLHRC Road King Classic	08-10	HD-1508		RK-3936	RK-3901PK	KN-171C*	*Black=KN-171B
96 CI	FLHRC Road King Classic	08-10	HD-1508		RK-3937	RK-3902PK	KN-171C*	*Black=KN-171B
96 CI	FLHRC Road King Classic	08-10	HD-1508		RK-3938	RK-3901PK	KN-171C*	*Black=KN-171B
96 CI	FLHRC Road King Classic	08-10	HD-1508		RK-3939	RK-3902PK	KN-171C*	*Black=KN-171B
96 CI	FLHRC Road King Classic	08-10	HD-1508		RK-3946	HD-0800DK	KN-171C*	*Black=KN-171B
96 CI	FLHRC Road King Classic	08-10	HD-1508		RK-3946B	HD-0800DK	KN-171C*	*Black=KN-171B
96 CI	FLHRC Road King Classic	08-10	HD-1508		RK-3946X		KN-171C*	*Black=KN-171B
96 CI	FLHRC Road King Classic	08-10	HD-1508		RK-3946XB		KN-171C*	*Black=KN-171B
96 CI	FLHRC Road King Classic	08-10	HD-1508		RK-3947		KN-171C*	*Black=KN-171B
96 CI	FLHRC Road King Classic	08-10	HD-1508		RK-3947B		KN-171C*	*Black=KN-171B
96 CI	FLHRC Road King Classic	08-10	HD-1508		RK-3947X		KN-171C*	*Black=KN-171B
96 CI	FLHRC Road King Classic	08-10	HD-1508		RK-3947XB		KN-171C*	*Black=KN-171B
96 CI	FLHRC Road King Classic	08-10	HD-1508		RK-3951*		KN-171C**	*Exc. Lower Fairings/ **Black=KN-171B
96 CI	FLHRC Road King Classic	08-10	HD-1508		RK-3951S*		KN-171C**	*Exc. Lower Fairings/ **Black=KN-171B
96 CI	FLHRS Road King Custom	07	HD-1499		63-1125*	RC-3680DK	KN-171C**	*Exc. Lower Fairings/ **Black=KN-171B
96 CI	FLHRS Road King Custom	07	HD-1499		63-1125P*	RC-3680DK	KN-171C**	*Exc. Lower Fairings/ **Black=KN-171B
96 CI	FLHRS Road King Custom	07	HD-1499		63-1137*		KN-171C**	*Exc. Lower Fairings/ **Black=KN-171B

2) Requires Two; 3) Requires Three; 4) Requires Four. The use of custom air filter requires removal of air box. Some custom filters and intakes are not legal for sale or use on any pollution controlled motor vehicle in California or states adopting California emission procedures. See knfilters.com for CARB status on each part for a specific vehicle.

Motorcycle - Application Listing



CC	Model	Year	Air Filter	Air Filter Precharger	Custom	Custom Precharger	Oil Filter	Comments
HARLEY DAVIDSON								
96 CI	FLHRS Road King Custom	07	HD-1499		63-1137S*		KN-171C**	*Exc. Lower Fairings/ **Black=KN-171B
96 CI	FLHRS Road King Custom	07	HD-1499		RK-3909-1*		KN-171C**	*w/1-5/8 inch Tall Filter/ **Black=KN-171B
96 CI	FLHRS Road King Custom	07	HD-1499		RK-3910-1*		KN-171C**	*w/2-1/4 inch Tall Filter/ **Black=KN-171B
96 CI	FLHRS Road King Custom	07	HD-1499		RK-3932		KN-171C*	*Black=KN-171B
96 CI	FLHRS Road King Custom	07	HD-1499		RK-3932B		KN-171C*	*Black=KN-171B
96 CI	FLHRS Road King Custom	07	HD-1499		RK-3932X		KN-171C*	*Black=KN-171B
96 CI	FLHRS Road King Custom	07	HD-1499		RK-3932XB		KN-171C*	*Black=KN-171B
96 CI	FLHRS Road King Custom	07	HD-1499		RK-3933	HD-0800DK	KN-171C*	*Black=KN-171B
96 CI	FLHRS Road King Custom	07	HD-1499		RK-3933B	HD-0800DK	KN-171C*	*Black=KN-171B
96 CI	FLHRS Road King Custom	07	HD-1499		RK-3933X		KN-171C*	*Black=KN-171B
96 CI	FLHRS Road King Custom	07	HD-1499		RK-3933XB		KN-171C*	*Black=KN-171B
96 CI	FLHRS Road King Custom	07	HD-1499		RK-3934	RK-3901PK	KN-171C*	*Black=KN-171B
96 CI	FLHRS Road King Custom	07	HD-1499		RK-3935	RK-3902PK	KN-171C*	*Black=KN-171B
96 CI	FLHRS Road King Custom	07	HD-1499		RK-3950*		KN-171C**	*Exc. Lower Fairings/ **Black=KN-171B
96 CI	FLHRS Road King Custom	07	HD-1499		RK-3950S*		KN-171C**	*Exc. Lower Fairings/ **Black=KN-171B
96 CI	FLHT Electra Glide Standard	07	HD-1499		63-1125*	RC-3680DK	KN-171C**	*Exc. Lower Fairings/ **Black=KN-171B
96 CI	FLHT Electra Glide Standard	07	HD-1499		63-1125P*	RC-3680DK	KN-171C**	*Exc. Lower Fairings/ **Black=KN-171B
96 CI	FLHT Electra Glide Standard	07	HD-1499		63-1137*		KN-171C**	*Exc. Lower Fairings/ **Black=KN-171B
96 CI	FLHT Electra Glide Standard	07	HD-1499		63-1137S*		KN-171C**	*Exc. Lower Fairings/ **Black=KN-171B
96 CI	FLHT Electra Glide Standard	07	HD-1499		RK-3909-1*		KN-171C**	*w/1-5/8 inch Tall Filter/ **Black=KN-171B
96 CI	FLHT Electra Glide Standard	07	HD-1499		RK-3910-1*		KN-171C**	*w/2-1/4 inch Tall Filter/ **Black=KN-171B
96 CI	FLHT Electra Glide Standard	07	HD-1499		RK-3932		KN-171C*	*Black=KN-171B
96 CI	FLHT Electra Glide Standard	07	HD-1499		RK-3932B		KN-171C*	*Black=KN-171B
96 CI	FLHT Electra Glide Standard	07	HD-1499		RK-3932X		KN-171C*	*Black=KN-171B
96 CI	FLHT Electra Glide Standard	07	HD-1499		RK-3932XB		KN-171C*	*Black=KN-171B
96 CI	FLHT Electra Glide Standard	07	HD-1499		RK-3933	HD-0800DK	KN-171C*	*Black=KN-171B
96 CI	FLHT Electra Glide Standard	07	HD-1499		RK-3933B	HD-0800DK	KN-171C*	*Black=KN-171B
96 CI	FLHT Electra Glide Standard	07	HD-1499		RK-3933X		KN-171C*	*Black=KN-171B
96 CI	FLHT Electra Glide Standard	07	HD-1499		RK-3933XB		KN-171C*	*Black=KN-171B
96 CI	FLHT Electra Glide Standard	07	HD-1499		RK-3934	RK-3901PK	KN-171C*	*Black=KN-171B
96 CI	FLHT Electra Glide Standard	07	HD-1499		RK-3935	RK-3902PK	KN-171C*	*Black=KN-171B
96 CI	FLHT Electra Glide Standard	07	HD-1499		RK-3950*		KN-171C**	*Exc. Lower Fairings/ **Black=KN-171B
96 CI	FLHT Electra Glide Standard	07	HD-1499		RK-3950S*		KN-171C**	*Exc. Lower Fairings/ **Black=KN-171B
96 CI	FLHT Electra Glide Standard	08-09	HD-1508		63-1122*	RC-3680DK	KN-171C**	*Exc. Lower Fairings/ **Black=KN-171B
96 CI	FLHT Electra Glide Standard	08-09	HD-1508		63-1122P*	RC-3680DK	KN-171C**	*Exc. Lower Fairings/ **Black=KN-171B
96 CI	FLHT Electra Glide Standard	08-09	HD-1508		63-1131*		KN-171C**	*w/Lower Fairings/ **Black=KN-171B
96 CI	FLHT Electra Glide Standard	08-09	HD-1508		63-1131P*		KN-171C**	*w/Lower Fairings/ **Black=KN-171B
96 CI	FLHT Electra Glide Standard	08-09	HD-1508		63-1134*		KN-171C**	*Exc. Lower Fairings/ **Black=KN-171B
96 CI	FLHT Electra Glide Standard	08-09	HD-1508		63-1134S*		KN-171C**	*Exc. Lower Fairings/ **Black=KN-171B
96 CI	FLHT Electra Glide Standard	08-09	HD-1508		RK-3930		KN-171C*	*Black=KN-171B
96 CI	FLHT Electra Glide Standard	08-09	HD-1508		RK-3930X		KN-171C*	*Black=KN-171B
96 CI	FLHT Electra Glide Standard	08-09	HD-1508		RK-3936	RK-3901PK	KN-171C*	*Black=KN-171B

2) Requires Two; 3) Requires Three; 4) Requires Four. The use of custom air filter requires removal of air box. Some custom filters and intakes are not legal for sale or use on any pollution controlled motor vehicle in California or states adopting California emission procedures. See knfilters.com for CARB status on each part for a specific vehicle.



Motorcycle - Application Listing

CC	Model	Year	Air Filter	Air Filter Precharger	Custom	Custom Precharger	Oil Filter	Comments
HARLEY DAVIDSON								
96 CI	FLHT Electra Glide Standard	08-09	HD-1508		RK-3937	RK-3902PK	KN-171C*	*Black=KN-171B
96 CI	FLHT Electra Glide Standard	08-09	HD-1508		RK-3938	RK-3901PK	KN-171C*	*Black=KN-171B
96 CI	FLHT Electra Glide Standard	08-09	HD-1508		RK-3939	RK-3902PK	KN-171C*	*Black=KN-171B
96 CI	FLHT Electra Glide Standard	08-09	HD-1508		RK-3946	HD-0800DK	KN-171C*	*Black=KN-171B
96 CI	FLHT Electra Glide Standard	08-09	HD-1508		RK-3946B	HD-0800DK	KN-171C*	*Black=KN-171B
96 CI	FLHT Electra Glide Standard	08-09	HD-1508		RK-3946X		KN-171C*	*Black=KN-171B
96 CI	FLHT Electra Glide Standard	08-09	HD-1508		RK-3946XB		KN-171C*	*Black=KN-171B
96 CI	FLHT Electra Glide Standard	08-09	HD-1508		RK-3947		KN-171C*	*Black=KN-171B
96 CI	FLHT Electra Glide Standard	08-09	HD-1508		RK-3947B		KN-171C*	*Black=KN-171B
96 CI	FLHT Electra Glide Standard	08-09	HD-1508		RK-3947X		KN-171C*	*Black=KN-171B
96 CI	FLHT Electra Glide Standard	08-09	HD-1508		RK-3947XB		KN-171C*	*Black=KN-171B
96 CI	FLHT Electra Glide Standard	08-09	HD-1508		RK-3951*		KN-171C**	*Exc. Lower Fairings/ **Black=KN-171B
96 CI	FLHT Electra Glide Standard	08-09	HD-1508		RK-3951S*		KN-171C**	*Exc. Lower Fairings/ **Black=KN-171B
96 CI	FLHT Electra Glide Standard	10	HD-1508		63-1122*	RC-3680DK		*Exc. Lower Fairings
96 CI	FLHT Electra Glide Standard	10	HD-1508		63-1122P*	RC-3680DK		*Exc. Lower Fairings
96 CI	FLHT Electra Glide Standard	10	HD-1508		63-1134*			*Exc. Lower Fairings
96 CI	FLHT Electra Glide Standard	10	HD-1508		63-1134S*			*Exc. Lower Fairings
96 CI	FLHT Electra Glide Standard	10	HD-1508		RK-3930			
96 CI	FLHT Electra Glide Standard	10	HD-1508		RK-3930X			
96 CI	FLHT Electra Glide Standard	10	HD-1508		RK-3936	RK-3901PK		
96 CI	FLHT Electra Glide Standard	10	HD-1508		RK-3937	RK-3902PK		
96 CI	FLHT Electra Glide Standard	10	HD-1508		RK-3938	RK-3901PK		
96 CI	FLHT Electra Glide Standard	10	HD-1508		RK-3939	RK-3902PK		
96 CI	FLHT Electra Glide Standard	10	HD-1508		RK-3951*			*Exc. Lower Fairings
96 CI	FLHT Electra Glide Standard	10	HD-1508		RK-3951S*			*Exc. Lower Fairings
96 CI	FLHTC Electra Glide Classic	07	HD-1499		63-1125*	RC-3680DK	KN-171C**	*Exc. Lower Fairings/ **Black=KN-171B
96 CI	FLHTC Electra Glide Classic	07	HD-1499		63-1125P*	RC-3680DK	KN-171C**	*Exc. Lower Fairings/ **Black=KN-171B
96 CI	FLHTC Electra Glide Classic	07	HD-1499		63-1137*		KN-171C**	*Exc. Lower Fairings/ **Black=KN-171B
96 CI	FLHTC Electra Glide Classic	07	HD-1499		63-1137S*		KN-171C**	*Exc. Lower Fairings/ **Black=KN-171B
96 CI	FLHTC Electra Glide Classic	07	HD-1499		RK-3909-1*		KN-171C**	*w/1-5/8 inch Tall Filter/ **Black=KN-171B
96 CI	FLHTC Electra Glide Classic	07	HD-1499		RK-3910-1*		KN-171C**	*w/2-1/4 inch Tall Filter/ **Black=KN-171B
96 CI	FLHTC Electra Glide Classic	07	HD-1499		RK-3932		KN-171C*	*Black=KN-171B
96 CI	FLHTC Electra Glide Classic	07	HD-1499		RK-3932B		KN-171C*	*Black=KN-171B
96 CI	FLHTC Electra Glide Classic	07	HD-1499		RK-3932X		KN-171C*	*Black=KN-171B
96 CI	FLHTC Electra Glide Classic	07	HD-1499		RK-3932XB		KN-171C*	*Black=KN-171B
96 CI	FLHTC Electra Glide Classic	07	HD-1499		RK-3933	HD-0800DK	KN-171C*	*Black=KN-171B
96 CI	FLHTC Electra Glide Classic	07	HD-1499		RK-3933B	HD-0800DK	KN-171C*	*Black=KN-171B
96 CI	FLHTC Electra Glide Classic	07	HD-1499		RK-3933X		KN-171C*	*Black=KN-171B
96 CI	FLHTC Electra Glide Classic	07	HD-1499		RK-3933XB		KN-171C*	*Black=KN-171B
96 CI	FLHTC Electra Glide Classic	07	HD-1499		RK-3934	RK-3901PK	KN-171C*	*Black=KN-171B
96 CI	FLHTC Electra Glide Classic	07	HD-1499		RK-3935	RK-3902PK	KN-171C*	*Black=KN-171B
96 CI	FLHTC Electra Glide Classic	07	HD-1499		RK-3950*		KN-171C**	*Exc. Lower Fairings/ **Black=KN-171B
96 CI	FLHTC Electra Glide Classic	07	HD-1499		RK-3950S*		KN-171C**	*Exc. Lower Fairings/ **Black=KN-171B
96 CI	FLHTC Electra Glide Classic	08-11	HD-1508		63-1122*	RC-3680DK	KN-171C**	*Exc. Lower Fairings/ **Black=KN-171B
96 CI	FLHTC Electra Glide Classic	08-11	HD-1508		63-1122P*	RC-3680DK	KN-171C**	*Exc. Lower Fairings/ **Black=KN-171B
96 CI	FLHTC Electra Glide Classic	08-11	HD-1508		63-1131*		KN-171C**	*w/Lower Fairings/ **Black=KN-171B

2) Requires Two; 3) Requires Three; 4) Requires Four. The use of custom air filter requires removal of air box. Some custom filters and intakes are not legal for sale or use on any pollution controlled motor vehicle in California or states adopting California emission procedures. See knfilters.com for CARB status on each part for a specific vehicle.

Motorcycle - Application Listing



CC	Model	Year	Air Filter	Air Filter Precharger	Custom	Custom Precharger	Oil Filter	Comments
HARLEY DAVIDSON								
96 CI	FLHTC Electra Glide Classic	08-11	HD-1508		63-1131P*		KN-171C**	*w/Lower Fairings/ **Black=KN-171B
96 CI	FLHTC Electra Glide Classic	08-11	HD-1508		63-1134*		KN-171C**	*Exc. Lower Fairings/ **Black=KN-171B
96 CI	FLHTC Electra Glide Classic	08-11	HD-1508		63-1134S*		KN-171C**	*Exc. Lower Fairings/ **Black=KN-171B
96 CI	FLHTC Electra Glide Classic	08-11	HD-1508		RK-3930		KN-171C*	*Black=KN-171B
96 CI	FLHTC Electra Glide Classic	08-11	HD-1508		RK-3930X		KN-171C*	*Black=KN-171B
96 CI	FLHTC Electra Glide Classic	08-11	HD-1508		RK-3936	RK-3901PK	KN-171C*	*Black=KN-171B
96 CI	FLHTC Electra Glide Classic	08-11	HD-1508		RK-3937	RK-3902PK	KN-171C*	*Black=KN-171B
96 CI	FLHTC Electra Glide Classic	08-11	HD-1508		RK-3938	RK-3901PK	KN-171C*	*Black=KN-171B
96 CI	FLHTC Electra Glide Classic	08-11	HD-1508		RK-3939	RK-3902PK	KN-171C*	*Black=KN-171B
96 CI	FLHTC Electra Glide Classic	08-11	HD-1508		RK-3946	HD-0800DK	KN-171C*	*Black=KN-171B
96 CI	FLHTC Electra Glide Classic	08-11	HD-1508		RK-3946B	HD-0800DK	KN-171C*	*Black=KN-171B
96 CI	FLHTC Electra Glide Classic	08-11	HD-1508		RK-3946X		KN-171C*	*Black=KN-171B
96 CI	FLHTC Electra Glide Classic	08-11	HD-1508		RK-3946XB		KN-171C*	*Black=KN-171B
96 CI	FLHTC Electra Glide Classic	08-11	HD-1508		RK-3947		KN-171C*	*Black=KN-171B
96 CI	FLHTC Electra Glide Classic	08-11	HD-1508		RK-3947B		KN-171C*	*Black=KN-171B
96 CI	FLHTC Electra Glide Classic	08-11	HD-1508		RK-3947X		KN-171C*	*Black=KN-171B
96 CI	FLHTC Electra Glide Classic	08-11	HD-1508		RK-3947XB		KN-171C*	*Black=KN-171B
96 CI	FLHTC Electra Glide Classic	08-11	HD-1508		RK-3951*		KN-171C**	*Exc. Lower Fairings/ **Black=KN-171B
96 CI	FLHTC Electra Glide Classic	08-11	HD-1508		RK-3951S*		KN-171C**	*Exc. Lower Fairings/ **Black=KN-171B
96 CI	FLHTCU Ultra Classic Electra Glide	07	HD-1499		63-1125*	RC-3680DK	KN-171C**	*Exc. Lower Fairings/ **Black=KN-171B
96 CI	FLHTCU Ultra Classic Electra Glide	07	HD-1499		63-1125P*	RC-3680DK	KN-171C**	*Exc. Lower Fairings/ **Black=KN-171B
96 CI	FLHTCU Ultra Classic Electra Glide	07	HD-1499		63-1137*		KN-171C**	*Exc. Lower Fairings/ **Black=KN-171B
96 CI	FLHTCU Ultra Classic Electra Glide	07	HD-1499		63-1137S*		KN-171C**	*Exc. Lower Fairings/ **Black=KN-171B
96 CI	FLHTCU Ultra Classic Electra Glide	07	HD-1499		RK-3909-1*		KN-171C**	*w/1-5/8 inch Tall Filter/ **Black=KN-171B
96 CI	FLHTCU Ultra Classic Electra Glide	07	HD-1499		RK-3910-1*		KN-171C**	*w/2-1/4 inch Tall Filter/ **Black=KN-171B
96 CI	FLHTCU Ultra Classic Electra Glide	07	HD-1499		RK-3932		KN-171C*	*Black=KN-171B
96 CI	FLHTCU Ultra Classic Electra Glide	07	HD-1499		RK-3932B		KN-171C*	*Black=KN-171B
96 CI	FLHTCU Ultra Classic Electra Glide	07	HD-1499		RK-3932X		KN-171C*	*Black=KN-171B
96 CI	FLHTCU Ultra Classic Electra Glide	07	HD-1499		RK-3932XB		KN-171C*	*Black=KN-171B
96 CI	FLHTCU Ultra Classic Electra Glide	07	HD-1499		RK-3933	HD-0800DK	KN-171C*	*Black=KN-171B
96 CI	FLHTCU Ultra Classic Electra Glide	07	HD-1499		RK-3933B	HD-0800DK	KN-171C*	*Black=KN-171B
96 CI	FLHTCU Ultra Classic Electra Glide	07	HD-1499		RK-3933X		KN-171C*	*Black=KN-171B
96 CI	FLHTCU Ultra Classic Electra Glide	07	HD-1499		RK-3933XB		KN-171C*	*Black=KN-171B
96 CI	FLHTCU Ultra Classic Electra Glide	07	HD-1499		RK-3934	RK-3901PK	KN-171C*	*Black=KN-171B
96 CI	FLHTCU Ultra Classic Electra Glide	07	HD-1499		RK-3935	RK-3902PK	KN-171C*	*Black=KN-171B
96 CI	FLHTCU Ultra Classic Electra Glide	07	HD-1499		RK-3950*		KN-171C**	*Exc. Lower Fairings/ **Black=KN-171B
96 CI	FLHTCU Ultra Classic Electra Glide	07	HD-1499		RK-3950S*		KN-171C**	*Exc. Lower Fairings/ **Black=KN-171B
96 CI	FLHTCU Ultra Classic Electra Glide	08-11	HD-1508		63-1131*		KN-171C**	*w/Lower Fairings/ **Black=KN-171B
96 CI	FLHTCU Ultra Classic Electra Glide	08-11	HD-1508		63-1131P*		KN-171C**	*w/Lower Fairings/ **Black=KN-171B
96 CI	FLHTCU Ultra Classic Electra Glide	08-11	HD-1508		RK-3930		KN-171C*	*Black=KN-171B
96 CI	FLHTCU Ultra Classic Electra Glide	08-11	HD-1508		RK-3930X		KN-171C*	*Black=KN-171B
96 CI	FLHTCU Ultra Classic Electra Glide	08-11	HD-1508		RK-3936	RK-3901PK	KN-171C*	*Black=KN-171B
96 CI	FLHTCU Ultra Classic Electra Glide	08-11	HD-1508		RK-3937	RK-3902PK	KN-171C*	*Black=KN-171B
96 CI	FLHTCU Ultra Classic Electra Glide	08-11	HD-1508		RK-3938	RK-3901PK	KN-171C*	*Black=KN-171B

2) Requires Two; 3) Requires Three; 4) Requires Four. The use of custom air filter requires removal of air box. Some custom filters and intakes are not legal for sale or use on any pollution controlled motor vehicle in California or states adopting California emission procedures. See knfilters.com for CARB status on each part for a specific vehicle.



Motorcycle - Application Listing

CC	Model	Year	Air Filter	Air Filter Precharger	Custom	Custom Precharger	Oil Filter	Comments
HARLEY DAVIDSON								
96 CI	FLHTCU Ultra Classic Electra Glide	08-11	HD-1508		RK-3939	RK-3902PK	KN-171C*	*Black=KN-171B
96 CI	FLHTCU Ultra Classic Electra Glide	08-11	HD-1508		RK-3946	HD-0800DK	KN-171C*	*Black=KN-171B
96 CI	FLHTCU Ultra Classic Electra Glide	08-11	HD-1508		RK-3946B	HD-0800DK	KN-171C*	*Black=KN-171B
96 CI	FLHTCU Ultra Classic Electra Glide	08-11	HD-1508		RK-3946X		KN-171C*	*Black=KN-171B
96 CI	FLHTCU Ultra Classic Electra Glide	08-11	HD-1508		RK-3946XB		KN-171C*	*Black=KN-171B
96 CI	FLHTCU Ultra Classic Electra Glide	08-11	HD-1508		RK-3947		KN-171C*	*Black=KN-171B
96 CI	FLHTCU Ultra Classic Electra Glide	08-11	HD-1508		RK-3947B		KN-171C*	*Black=KN-171B
96 CI	FLHTCU Ultra Classic Electra Glide	08-11	HD-1508		RK-3947X		KN-171C*	*Black=KN-171B
96 CI	FLHTCU Ultra Classic Electra Glide	08-11	HD-1508		RK-3947XB		KN-171C*	*Black=KN-171B
96 CI	FLHX Street Glide	07	HD-1499		63-1125*	RC-3680DK	KN-171C**	*Exc. Lower Fairings/ **Black=KN-171B
96 CI	FLHX Street Glide	07	HD-1499		63-1125P*	RC-3680DK	KN-171C**	*Exc. Lower Fairings/ **Black=KN-171B
96 CI	FLHX Street Glide	07	HD-1499		63-1137*		KN-171C**	*Exc. Lower Fairings/ **Black=KN-171B
96 CI	FLHX Street Glide	07	HD-1499		63-1137S*		KN-171C**	*Exc. Lower Fairings/ **Black=KN-171B
96 CI	FLHX Street Glide	07	HD-1499		RK-3909-1*		KN-171C**	*w/1-5/8 inch Tall Filter/ **Black=KN-171B
96 CI	FLHX Street Glide	07	HD-1499		RK-3910-1*		KN-171C**	*w/2-1/4 inch Tall Filter/ **Black=KN-171B
96 CI	FLHX Street Glide	07	HD-1499		RK-3932		KN-171C*	*Black=KN-171B
96 CI	FLHX Street Glide	07	HD-1499		RK-3932B		KN-171C*	*Black=KN-171B
96 CI	FLHX Street Glide	07	HD-1499		RK-3932X		KN-171C*	*Black=KN-171B
96 CI	FLHX Street Glide	07	HD-1499		RK-3932XB		KN-171C*	*Black=KN-171B
96 CI	FLHX Street Glide	07	HD-1499		RK-3933	HD-0800DK	KN-171C*	*Black=KN-171B
96 CI	FLHX Street Glide	07	HD-1499		RK-3933B	HD-0800DK	KN-171C*	*Black=KN-171B
96 CI	FLHX Street Glide	07	HD-1499		RK-3933X		KN-171C*	*Black=KN-171B
96 CI	FLHX Street Glide	07	HD-1499		RK-3933XB		KN-171C*	*Black=KN-171B
96 CI	FLHX Street Glide	07	HD-1499		RK-3934	RK-3901PK	KN-171C*	*Black=KN-171B
96 CI	FLHX Street Glide	07	HD-1499		RK-3935	RK-3902PK	KN-171C*	*Black=KN-171B
96 CI	FLHX Street Glide	07	HD-1499		RK-3950*		KN-171C**	*Exc. Lower Fairings/ **Black=KN-171B
96 CI	FLHX Street Glide	07	HD-1499		RK-3950S*		KN-171C**	*Exc. Lower Fairings/ **Black=KN-171B
96 CI	FLHX Street Glide	08	HD-1508		RK-3932		KN-171C*	*Black=KN-171B
96 CI	FLHX Street Glide	08	HD-1508		RK-3932B		KN-171C*	*Black=KN-171B
96 CI	FLHX Street Glide	08	HD-1508		RK-3932X		KN-171C*	*Black=KN-171B
96 CI	FLHX Street Glide	08	HD-1508		RK-3932XB		KN-171C*	*Black=KN-171B
96 CI	FLHX Street Glide	08	HD-1508		RK-3934	RK-3901PK	KN-171C*	*Black=KN-171B
96 CI	FLHX Street Glide	08	HD-1508		RK-3935	RK-3902PK	KN-171C*	*Black=KN-171B
96 CI	FLHX Street Glide	08-11	HD-1508		63-1122*	RC-3680DK	KN-171C**	*Exc. Lower Fairings/ **Black=KN-171B
96 CI	FLHX Street Glide	08-11	HD-1508		63-1122P*	RC-3680DK	KN-171C**	*Exc. Lower Fairings/ **Black=KN-171B
96 CI	FLHX Street Glide	08-11	HD-1508		63-1131*		KN-171C**	*w/Lower Fairings/ **Black=KN-171B
96 CI	FLHX Street Glide	08-11	HD-1508		63-1131P*		KN-171C**	*w/Lower Fairings/ **Black=KN-171B
96 CI	FLHX Street Glide	08-11	HD-1508		63-1134*		KN-171C**	*Exc. Lower Fairings/ **Black=KN-171B
96 CI	FLHX Street Glide	08-11	HD-1508		63-1134S*		KN-171C**	*Exc. Lower Fairings/ **Black=KN-171B
96 CI	FLHX Street Glide	08-11	HD-1508		RK-3930		KN-171C*	*Black=KN-171B
96 CI	FLHX Street Glide	08-11	HD-1508		RK-3930X		KN-171C*	*Black=KN-171B
96 CI	FLHX Street Glide	08-11	HD-1508		RK-3936	RK-3901PK	KN-171C*	*Black=KN-171B
96 CI	FLHX Street Glide	08-11	HD-1508		RK-3937	RK-3902PK	KN-171C*	*Black=KN-171B
96 CI	FLHX Street Glide	08-11	HD-1508		RK-3938	RK-3901PK	KN-171C*	*Black=KN-171B
96 CI	FLHX Street Glide	08-11	HD-1508		RK-3939	RK-3902PK	KN-171C*	*Black=KN-171B

2) Requires Two; 3) Requires Three; 4) Requires Four. The use of custom air filter requires removal of air box. Some custom filters and intakes are not legal for sale or use on any pollution controlled motor vehicle in California or states adopting California emission procedures. See knfilters.com for CARB status on each part for a specific vehicle.

Motorcycle - Application Listing



CC	Model	Year	Air Filter	Air Filter Precharger	Custom	Custom Precharger	Oil Filter	Comments
HARLEY DAVIDSON								
96 CI	FLHX Street Glide	08-11	HD-1508		RK-3946	HD-0800DK	KN-171C*	*Black=KN-171B
96 CI	FLHX Street Glide	08-11	HD-1508		RK-3946B	HD-0800DK	KN-171C*	*Black=KN-171B
96 CI	FLHX Street Glide	08-11	HD-1508		RK-3946X		KN-171C*	*Black=KN-171B
96 CI	FLHX Street Glide	08-11	HD-1508		RK-3946XB		KN-171C*	*Black=KN-171B
96 CI	FLHX Street Glide	08-11	HD-1508		RK-3947		KN-171C*	*Black=KN-171B
96 CI	FLHX Street Glide	08-11	HD-1508		RK-3947B		KN-171C*	*Black=KN-171B
96 CI	FLHX Street Glide	08-11	HD-1508		RK-3947X		KN-171C*	*Black=KN-171B
96 CI	FLHX Street Glide	08-11	HD-1508		RK-3947XB		KN-171C*	*Black=KN-171B
96 CI	FLHX Street Glide	08-11	HD-1508		RK-3951*		KN-171C**	*Exc. Lower Fairings/ **Black=KN-171B
96 CI	FLHX Street Glide	08-11	HD-1508		RK-3951S*		KN-171C**	*Exc. Lower Fairings/ **Black=KN-171B
96 CI	FLSTC Heritage Softail Classic	07-11	HD-1499		63-1125*	RC-3680DK	KN-171C**	*Exc. Lower Fairings/ **Black=KN-171B
96 CI	FLSTC Heritage Softail Classic	07-11	HD-1499		63-1125P*	RC-3680DK	KN-171C**	*Exc. Lower Fairings/ **Black=KN-171B
96 CI	FLSTC Heritage Softail Classic	07-11	HD-1499		63-1137*		KN-171C**	*Exc. Lower Fairings/ **Black=KN-171B
96 CI	FLSTC Heritage Softail Classic	07-11	HD-1499		63-1137S*		KN-171C**	*Exc. Lower Fairings/ **Black=KN-171B
96 CI	FLSTC Heritage Softail Classic	07-11	HD-1499		RK-3909-1*		KN-171C**	*w/1-5/8 inch Tall Filter/ **Black=KN-171B
96 CI	FLSTC Heritage Softail Classic	07-11	HD-1499		RK-3910-1*		KN-171C**	*w/2-1/4 inch Tall Filter/ **Black=KN-171B
96 CI	FLSTC Heritage Softail Classic	07-11	HD-1499		RK-3932		KN-171C*	*Black=KN-171B
96 CI	FLSTC Heritage Softail Classic	07-11	HD-1499		RK-3932B		KN-171C*	*Black=KN-171B
96 CI	FLSTC Heritage Softail Classic	07-11	HD-1499		RK-3932X		KN-171C*	*Black=KN-171B
96 CI	FLSTC Heritage Softail Classic	07-11	HD-1499		RK-3932XB		KN-171C*	*Black=KN-171B
96 CI	FLSTC Heritage Softail Classic	07-11	HD-1499		RK-3933	HD-0800DK	KN-171C*	*Black=KN-171B
96 CI	FLSTC Heritage Softail Classic	07-11	HD-1499		RK-3933B	HD-0800DK	KN-171C*	*Black=KN-171B
96 CI	FLSTC Heritage Softail Classic	07-11	HD-1499		RK-3933X		KN-171C*	*Black=KN-171B
96 CI	FLSTC Heritage Softail Classic	07-11	HD-1499		RK-3933XB		KN-171C*	*Black=KN-171B
96 CI	FLSTC Heritage Softail Classic	07-11	HD-1499		RK-3934	RK-3901PK	KN-171C*	*Black=KN-171B
96 CI	FLSTC Heritage Softail Classic	07-11	HD-1499		RK-3935	RK-3902PK	KN-171C*	*Black=KN-171B
96 CI	FLSTC Heritage Softail Classic	07-11	HD-1499		RK-3950*		KN-171C**	*Exc. Lower Fairings/ **Black=KN-171B
96 CI	FLSTC Heritage Softail Classic	07-11	HD-1499		RK-3950S*		KN-171C**	*Exc. Lower Fairings/ **Black=KN-171B
96 CI	FLSTF Fat Boy	03-06					KN-171C*	*Black=KN-171B
96 CI	FLSTF Fat Boy	07-11	HD-1499		63-1125*	RC-3680DK	KN-171C**	*Exc. Lower Fairings/ **Black=KN-171B
96 CI	FLSTF Fat Boy	07-11	HD-1499		63-1125P*	RC-3680DK	KN-171C**	*Exc. Lower Fairings/ **Black=KN-171B
96 CI	FLSTF Fat Boy	07-11	HD-1499		63-1137*		KN-171C**	*Exc. Lower Fairings/ **Black=KN-171B
96 CI	FLSTF Fat Boy	07-11	HD-1499		63-1137S*		KN-171C**	*Exc. Lower Fairings/ **Black=KN-171B
96 CI	FLSTF Fat Boy	07-11	HD-1499		RK-3909-1*		KN-171C**	*w/1-5/8 inch Tall Filter/ **Black=KN-171B
96 CI	FLSTF Fat Boy	07-11	HD-1499		RK-3910-1*		KN-171C**	*w/2-1/4 inch Tall Filter/ **Black=KN-171B
96 CI	FLSTF Fat Boy	07-11	HD-1499		RK-3932		KN-171C*	*Black=KN-171B
96 CI	FLSTF Fat Boy	07-11	HD-1499		RK-3932B		KN-171C*	*Black=KN-171B
96 CI	FLSTF Fat Boy	07-11	HD-1499		RK-3932X		KN-171C*	*Black=KN-171B
96 CI	FLSTF Fat Boy	07-11	HD-1499		RK-3932XB		KN-171C*	*Black=KN-171B
96 CI	FLSTF Fat Boy	07-11	HD-1499		RK-3933	HD-0800DK	KN-171C*	*Black=KN-171B
96 CI	FLSTF Fat Boy	07-11	HD-1499		RK-3933B	HD-0800DK	KN-171C*	*Black=KN-171B
96 CI	FLSTF Fat Boy	07-11	HD-1499		RK-3933X		KN-171C*	*Black=KN-171B
96 CI	FLSTF Fat Boy	07-11	HD-1499		RK-3933XB		KN-171C*	*Black=KN-171B
96 CI	FLSTF Fat Boy	07-11	HD-1499		RK-3934	RK-3901PK	KN-171C*	*Black=KN-171B

2) Requires Two; 3) Requires Three; 4) Requires Four. The use of custom air filter requires removal of air box. Some custom filters and intakes are not legal for sale or use on any pollution controlled motor vehicle in California or states adopting California emission procedures. See knfilters.com for CARB status on each part for a specific vehicle.



Motorcycle - Application Listing

CC	Model	Year	Air Filter	Air Filter Precharger	Custom	Custom Precharger	Oil Filter	Comments
HARLEY DAVIDSON								
96 CI	FLSTF Fat Boy	07-11	HD-1499		RK-3935	RK-3902PK	KN-171C*	*Black=KN-171B
96 CI	FLSTF Fat Boy	07-11	HD-1499		RK-3950*		KN-171C**	*Exc. Lower Fairings/ **Black=KN-171B
96 CI	FLSTF Fat Boy	07-11	HD-1499		RK-3950S*		KN-171C**	*Exc. Lower Fairings/ **Black=KN-171B
96 CI	FLSTFB Softail Fat Boy Lo	10-11	HD-1499		63-1125*	RC-3680DK	KN-171C**	*Exc. Lower Fairings/ **Black=KN-171B
96 CI	FLSTFB Softail Fat Boy Lo	10-11	HD-1499		63-1125P*	RC-3680DK	KN-171C**	*Exc. Lower Fairings/ **Black=KN-171B
96 CI	FLSTFB Softail Fat Boy Lo	10-11	HD-1499		63-1137*		KN-171C**	*Exc. Lower Fairings/ **Black=KN-171B
96 CI	FLSTFB Softail Fat Boy Lo	10-11	HD-1499		63-1137S*		KN-171C**	*Exc. Lower Fairings/ **Black=KN-171B
96 CI	FLSTFB Softail Fat Boy Lo	10-11	HD-1499		RK-3909-1*		KN-171C**	*w/1-5/8 inch Tall Filter/ **Black=KN-171B
96 CI	FLSTFB Softail Fat Boy Lo	10-11	HD-1499		RK-3910-1*		KN-171C**	*w/2-1/4 inch Tall Filter/ **Black=KN-171B
96 CI	FLSTFB Softail Fat Boy Lo	10-11	HD-1499		RK-3932		KN-171C*	*Black=KN-171B
96 CI	FLSTFB Softail Fat Boy Lo	10-11	HD-1499		RK-3932B		KN-171C*	*Black=KN-171B
96 CI	FLSTFB Softail Fat Boy Lo	10-11	HD-1499		RK-3932X		KN-171C*	*Black=KN-171B
96 CI	FLSTFB Softail Fat Boy Lo	10-11	HD-1499		RK-3932XB		KN-171C*	*Black=KN-171B
96 CI	FLSTFB Softail Fat Boy Lo	10-11	HD-1499		RK-3933	HD-0800DK	KN-171C*	*Black=KN-171B
96 CI	FLSTFB Softail Fat Boy Lo	10-11	HD-1499		RK-3933B	HD-0800DK	KN-171C*	*Black=KN-171B
96 CI	FLSTFB Softail Fat Boy Lo	10-11	HD-1499		RK-3933X		KN-171C*	*Black=KN-171B
96 CI	FLSTFB Softail Fat Boy Lo	10-11	HD-1499		RK-3933XB		KN-171C*	*Black=KN-171B
96 CI	FLSTFB Softail Fat Boy Lo	10-11	HD-1499		RK-3934	RK-3901PK	KN-171C*	*Black=KN-171B
96 CI	FLSTFB Softail Fat Boy Lo	10-11	HD-1499		RK-3935	RK-3902PK	KN-171C*	*Black=KN-171B
96 CI	FLSTFB Softail Fat Boy Lo	10-11	HD-1499		RK-3950*		KN-171C**	*Exc. Lower Fairings/ **Black=KN-171B
96 CI	FLSTFB Softail Fat Boy Lo	10-11	HD-1499		RK-3950S*		KN-171C**	*Exc. Lower Fairings/ **Black=KN-171B
96 CI	FLSTN Softail Deluxe	07-11	HD-1499		63-1125*	RC-3680DK	KN-171C**	*Exc. Lower Fairings/ **Black=KN-171B
96 CI	FLSTN Softail Deluxe	07-11	HD-1499		63-1125P*	RC-3680DK	KN-171C**	*Exc. Lower Fairings/ **Black=KN-171B
96 CI	FLSTN Softail Deluxe	07-11	HD-1499		63-1137*		KN-171C**	*Exc. Lower Fairings/ **Black=KN-171B
96 CI	FLSTN Softail Deluxe	07-11	HD-1499		63-1137S*		KN-171C**	*Exc. Lower Fairings/ **Black=KN-171B
96 CI	FLSTN Softail Deluxe	07-11	HD-1499		RK-3909-1*		KN-171C**	*w/1-5/8 inch Tall Filter/ **Black=KN-171B
96 CI	FLSTN Softail Deluxe	07-11	HD-1499		RK-3910-1*		KN-171C**	*w/2-1/4 inch Tall Filter/ **Black=KN-171B
96 CI	FLSTN Softail Deluxe	07-11	HD-1499		RK-3932		KN-171C*	*Black=KN-171B
96 CI	FLSTN Softail Deluxe	07-11	HD-1499		RK-3932B		KN-171C*	*Black=KN-171B
96 CI	FLSTN Softail Deluxe	07-11	HD-1499		RK-3932X		KN-171C*	*Black=KN-171B
96 CI	FLSTN Softail Deluxe	07-11	HD-1499		RK-3932XB		KN-171C*	*Black=KN-171B
96 CI	FLSTN Softail Deluxe	07-11	HD-1499		RK-3933	HD-0800DK	KN-171C*	*Black=KN-171B
96 CI	FLSTN Softail Deluxe	07-11	HD-1499		RK-3933B	HD-0800DK	KN-171C*	*Black=KN-171B
96 CI	FLSTN Softail Deluxe	07-11	HD-1499		RK-3933X		KN-171C*	*Black=KN-171B
96 CI	FLSTN Softail Deluxe	07-11	HD-1499		RK-3933XB		KN-171C*	*Black=KN-171B
96 CI	FLSTN Softail Deluxe	07-11	HD-1499		RK-3934	RK-3901PK	KN-171C*	*Black=KN-171B
96 CI	FLSTN Softail Deluxe	07-11	HD-1499		RK-3935	RK-3902PK	KN-171C*	*Black=KN-171B
96 CI	FLSTN Softail Deluxe	07-11	HD-1499		RK-3950*		KN-171C**	*Exc. Lower Fairings/ **Black=KN-171B
96 CI	FLSTN Softail Deluxe	07-11	HD-1499		RK-3950S*		KN-171C**	*Exc. Lower Fairings/ **Black=KN-171B
96 CI	FLSTSB Softail Cross Bones	08-09	HD-1499*		63-1125**	RC-3680DK	KN-171C***	*Non-US/ **Exc. Lower Fairings/ ***Black=KN-171B
96 CI	FLSTSB Softail Cross Bones	08-09	HD-1499*		63-1125P**	RC-3680DK	KN-171C***	*Non-US/ **Exc. Lower Fairings/ ***Black=KN-171B

2) Requires Two; 3) Requires Three; 4) Requires Four. The use of custom air filter requires removal of air box. Some custom filters and intakes are not legal for sale or use on any pollution controlled motor vehicle in California or states adopting California emission procedures. See knfilters.com for CARB status on each part for a specific vehicle.

Motorcycle - Application Listing



CC	Model	Year	Air Filter	Air Filter Precharger	Custom	Custom Precharger	Oil Filter	Comments
HARLEY DAVIDSON								
96 CI	FLSTSB Softail Cross Bones	08-09	HD-1499*		63-1137**		KN-171C***	*Non-US/ **Exc. Lower Fairings/ ***Black=KN-171B
96 CI	FLSTSB Softail Cross Bones	08-09	HD-1499*		63-1137S**		KN-171C***	*Non-US/ **Exc. Lower Fairings/ ***Black=KN-171B
96 CI	FLSTSB Softail Cross Bones	08-09	HD-1499*		RK-3932		KN-171C**	*Non-US/ **Black=KN-171B
96 CI	FLSTSB Softail Cross Bones	08-09	HD-1499*		RK-3932B		KN-171C**	*Non-US/ **Black=KN-171B
96 CI	FLSTSB Softail Cross Bones	08-09	HD-1499*		RK-3932X		KN-171C**	*Non-US/ **Black=KN-171B
96 CI	FLSTSB Softail Cross Bones	08-09	HD-1499*		RK-3932XB		KN-171C**	*Non-US/ **Black=KN-171B
96 CI	FLSTSB Softail Cross Bones	08-09	HD-1499*		RK-3933	HD-0800DK	KN-171C**	*Non-US/ **Black=KN-171B
96 CI	FLSTSB Softail Cross Bones	08-09	HD-1499*		RK-3933B	HD-0800DK	KN-171C**	*Non-US/ **Black=KN-171B
96 CI	FLSTSB Softail Cross Bones	08-09	HD-1499*		RK-3933X		KN-171C**	*Non-US/ **Black=KN-171B
96 CI	FLSTSB Softail Cross Bones	08-09	HD-1499*		RK-3933XB		KN-171C**	*Non-US/ **Black=KN-171B
96 CI	FLSTSB Softail Cross Bones	08-09	HD-1499*		RK-3934	RK-3901PK	KN-171C**	*Non-US/ **Black=KN-171B
96 CI	FLSTSB Softail Cross Bones	08-09	HD-1499*		RK-3935	RK-3902PK	KN-171C**	*Non-US/ **Black=KN-171B
96 CI	FLSTSB Softail Cross Bones	08-09	HD-1499*		RK-3950**		KN-171C***	*Non-US/ **Exc. Lower Fairings/ ***Black=KN-171B
96 CI	FLSTSB Softail Cross Bones	08-09	HD-1499*		RK-3950S**		KN-171C***	*Non-US/ **Exc. Lower Fairings/ ***Black=KN-171B
96 CI	FLSTSB Softail Cross Bones	08-09	HD-1611*		63-1125**	RC-3680DK	KN-171C***	*US/ **Exc. Lower Fairings/ ***Black=KN-171B
96 CI	FLSTSB Softail Cross Bones	08-09	HD-1611*		63-1125P**	RC-3680DK	KN-171C***	*US/ **Exc. Lower Fairings/ ***Black=KN-171B
96 CI	FLSTSB Softail Cross Bones	08-09	HD-1611*		63-1137**		KN-171C***	*US/ **Exc. Lower Fairings/ ***Black=KN-171B
96 CI	FLSTSB Softail Cross Bones	08-09	HD-1611*		63-1137S**		KN-171C***	*US/ **Exc. Lower Fairings/ ***Black=KN-171B
96 CI	FLSTSB Softail Cross Bones	08-09	HD-1611*		RK-3932		KN-171C**	*US/ **Black=KN-171B
96 CI	FLSTSB Softail Cross Bones	08-09	HD-1611*		RK-3932B		KN-171C**	*US/ **Black=KN-171B
96 CI	FLSTSB Softail Cross Bones	08-09	HD-1611*		RK-3932X		KN-171C**	*US/ **Black=KN-171B
96 CI	FLSTSB Softail Cross Bones	08-09	HD-1611*		RK-3932XB		KN-171C**	*US/ **Black=KN-171B
96 CI	FLSTSB Softail Cross Bones	08-09	HD-1611*		RK-3933	HD-0800DK	KN-171C**	*US/ **Black=KN-171B
96 CI	FLSTSB Softail Cross Bones	08-09	HD-1611*		RK-3933B	HD-0800DK	KN-171C**	*US/ **Black=KN-171B
96 CI	FLSTSB Softail Cross Bones	08-09	HD-1611*		RK-3933X		KN-171C**	*US/ **Black=KN-171B
96 CI	FLSTSB Softail Cross Bones	08-09	HD-1611*		RK-3933XB		KN-171C**	*US/ **Black=KN-171B
96 CI	FLSTSB Softail Cross Bones	08-09	HD-1611*		RK-3934	RK-3901PK	KN-171C**	*US/ **Black=KN-171B
96 CI	FLSTSB Softail Cross Bones	08-09	HD-1611*		RK-3935	RK-3902PK	KN-171C**	*US/ **Black=KN-171B
96 CI	FLSTSB Softail Cross Bones	08-09	HD-1611*		RK-3950**		KN-171C***	*US/ **Exc. Lower Fairings/ ***Black=KN-171B
96 CI	FLSTSB Softail Cross Bones	08-09	HD-1611*		RK-3950S**		KN-171C***	*US/ **Exc. Lower Fairings/ ***Black=KN-171B
96 CI	FLSTSB Softail Cross Bones	10-11	HD-1611		63-1125*	RC-3680DK	KN-171C**	*Exc. Lower Fairings/ **Black=KN-171B
96 CI	FLSTSB Softail Cross Bones	10-11	HD-1611		63-1125P*	RC-3680DK	KN-171C**	*Exc. Lower Fairings/ **Black=KN-171B
96 CI	FLSTSB Softail Cross Bones	10-11	HD-1611		63-1137*		KN-171C**	*Exc. Lower Fairings/ **Black=KN-171B
96 CI	FLSTSB Softail Cross Bones	10-11	HD-1611		63-1137S*		KN-171C**	*Exc. Lower Fairings/ **Black=KN-171B
96 CI	FLSTSB Softail Cross Bones	10-11	HD-1611		RK-3932		KN-171C*	*Black=KN-171B
96 CI	FLSTSB Softail Cross Bones	10-11	HD-1611		RK-3932B		KN-171C*	*Black=KN-171B
96 CI	FLSTSB Softail Cross Bones	10-11	HD-1611		RK-3932X		KN-171C*	*Black=KN-171B
96 CI	FLSTSB Softail Cross Bones	10-11	HD-1611		RK-3932XB		KN-171C*	*Black=KN-171B
96 CI	FLSTSB Softail Cross Bones	10-11	HD-1611		RK-3933	HD-0800DK	KN-171C*	*Black=KN-171B
96 CI	FLSTSB Softail Cross Bones	10-11	HD-1611		RK-3933B	HD-0800DK	KN-171C*	*Black=KN-171B
96 CI	FLSTSB Softail Cross Bones	10-11	HD-1611		RK-3933X		KN-171C*	*Black=KN-171B
96 CI	FLSTSB Softail Cross Bones	10-11	HD-1611		RK-3933XB		KN-171C*	*Black=KN-171B
96 CI	FLSTSB Softail Cross Bones	10-11	HD-1611		RK-3934	RK-3901PK	KN-171C*	*Black=KN-171B
96 CI	FLSTSB Softail Cross Bones	10-11	HD-1611		RK-3935	RK-3902PK	KN-171C*	*Black=KN-171B

2) Requires Two; 3) Requires Three; 4) Requires Four. The use of custom air filter requires removal of air box. Some custom filters and intakes are not legal for sale or use on any pollution controlled motor vehicle in California or states adopting California emission procedures. See knfilters.com for CARB status on each part for a specific vehicle.



Motorcycle - Application Listing

CC	Model	Year	Air Filter	Air Filter Precharger	Custom	Custom Precharger	Oil Filter	Comments
HARLEY DAVIDSON								
96 CI	FLSTSB Softail Cross Bones	10-11	HD-1611		RK-3950*		KN-171C**	*Exc. Lower Fairings/ **Black=KN-171B
96 CI	FLSTSB Softail Cross Bones	10-11	HD-1611		RK-3950S*		KN-171C**	*Exc. Lower Fairings/ **Black=KN-171B
96 CI	FLSTSC Softail Springer Classic	07	HD-1499		63-1125*	RC-3680DK	KN-171C**	*Exc. Lower Fairings/ **Black=KN-171B
96 CI	FLSTSC Softail Springer Classic	07	HD-1499		63-1125P*	RC-3680DK	KN-171C**	*Exc. Lower Fairings/ **Black=KN-171B
96 CI	FLSTSC Softail Springer Classic	07	HD-1499		63-1137*		KN-171C**	*Exc. Lower Fairings/ **Black=KN-171B
96 CI	FLSTSC Softail Springer Classic	07	HD-1499		63-1137S*		KN-171C**	*Exc. Lower Fairings/ **Black=KN-171B
96 CI	FLSTSC Softail Springer Classic	07	HD-1499		RK-3909-1*		KN-171C**	*w/1-5/8 inch Tall Filter/ **Black=KN-171B
96 CI	FLSTSC Softail Springer Classic	07	HD-1499		RK-3910-1*		KN-171C**	*w/2-1/4 inch Tall Filter/ **Black=KN-171B
96 CI	FLSTSC Softail Springer Classic	07	HD-1499		RK-3932		KN-171C*	*Black=KN-171B
96 CI	FLSTSC Softail Springer Classic	07	HD-1499		RK-3932B		KN-171C*	*Black=KN-171B
96 CI	FLSTSC Softail Springer Classic	07	HD-1499		RK-3932X		KN-171C*	*Black=KN-171B
96 CI	FLSTSC Softail Springer Classic	07	HD-1499		RK-3932XB		KN-171C*	*Black=KN-171B
96 CI	FLSTSC Softail Springer Classic	07	HD-1499		RK-3933	HD-0800DK	KN-171C*	*Black=KN-171B
96 CI	FLSTSC Softail Springer Classic	07	HD-1499		RK-3933B	HD-0800DK	KN-171C*	*Black=KN-171B
96 CI	FLSTSC Softail Springer Classic	07	HD-1499		RK-3933X		KN-171C*	*Black=KN-171B
96 CI	FLSTSC Softail Springer Classic	07	HD-1499		RK-3933XB		KN-171C*	*Black=KN-171B
96 CI	FLSTSC Softail Springer Classic	07	HD-1499		RK-3934	RK-3901PK	KN-171C*	*Black=KN-171B
96 CI	FLSTSC Softail Springer Classic	07	HD-1499		RK-3935	RK-3902PK	KN-171C*	*Black=KN-171B
96 CI	FLSTSC Softail Springer Classic	07	HD-1499		RK-3950*		KN-171C**	*Exc. Lower Fairings/ **Black=KN-171B
96 CI	FLSTSC Softail Springer Classic	07	HD-1499		RK-3950S*		KN-171C**	*Exc. Lower Fairings/ **Black=KN-171B
96 CI	FLTR Road Glide	07	HD-1499		63-1125*	RC-3680DK	KN-171C**	*Exc. Lower Fairings/ **Black=KN-171B
96 CI	FLTR Road Glide	07	HD-1499		63-1125P*	RC-3680DK	KN-171C**	*Exc. Lower Fairings/ **Black=KN-171B
96 CI	FLTR Road Glide	07	HD-1499		63-1137*		KN-171C**	*Exc. Lower Fairings/ **Black=KN-171B
96 CI	FLTR Road Glide	07	HD-1499		63-1137S*		KN-171C**	*Exc. Lower Fairings/ **Black=KN-171B
96 CI	FLTR Road Glide	07	HD-1499		RK-3909-1*		KN-171C**	*w/1-5/8 inch Tall Filter/ **Black=KN-171B
96 CI	FLTR Road Glide	07	HD-1499		RK-3910-1*		KN-171C**	*w/2-1/4 inch Tall Filter/ **Black=KN-171B
96 CI	FLTR Road Glide	07	HD-1499		RK-3932		KN-171C*	*Black=KN-171B
96 CI	FLTR Road Glide	07	HD-1499		RK-3932B		KN-171C*	*Black=KN-171B
96 CI	FLTR Road Glide	07	HD-1499		RK-3932X		KN-171C*	*Black=KN-171B
96 CI	FLTR Road Glide	07	HD-1499		RK-3932XB		KN-171C*	*Black=KN-171B
96 CI	FLTR Road Glide	07	HD-1499		RK-3933	HD-0800DK	KN-171C*	*Black=KN-171B
96 CI	FLTR Road Glide	07	HD-1499		RK-3933B	HD-0800DK	KN-171C*	*Black=KN-171B
96 CI	FLTR Road Glide	07	HD-1499		RK-3933X		KN-171C*	*Black=KN-171B
96 CI	FLTR Road Glide	07	HD-1499		RK-3933XB		KN-171C*	*Black=KN-171B
96 CI	FLTR Road Glide	07	HD-1499		RK-3934	RK-3901PK	KN-171C*	*Black=KN-171B
96 CI	FLTR Road Glide	07	HD-1499		RK-3935	RK-3902PK	KN-171C*	*Black=KN-171B
96 CI	FLTR Road Glide	07	HD-1499		RK-3950*		KN-171C**	*Exc. Lower Fairings/ **Black=KN-171B
96 CI	FLTR Road Glide	07	HD-1499		RK-3950S*		KN-171C**	*Exc. Lower Fairings/ **Black=KN-171B
96 CI	FLTR Road Glide	08-09	HD-1508		63-1131*		KN-171C**	*w/Lower Fairings/ **Black=KN-171B
96 CI	FLTR Road Glide	08-09	HD-1508		63-1131P*		KN-171C**	*w/Lower Fairings/ **Black=KN-171B
96 CI	FLTR Road Glide	08-09	HD-1508		RK-3946	HD-0800DK	KN-171C*	*Black=KN-171B

2) Requires Two; 3) Requires Three; 4) Requires Four. The use of custom air filter requires removal of air box. Some custom filters and intakes are not legal for sale or use on any pollution controlled motor vehicle in California or states adopting California emission procedures. See knfilters.com for CARB status on each part for a specific vehicle.

Motorcycle - Application Listing



CC	Model	Year	Air Filter	Air Filter Precharger	Custom	Custom Precharger	Oil Filter	Comments
HARLEY DAVIDSON								
96 CI	FLTR Road Glide	08-09	HD-1508		RK-3946B	HD-0800DK	KN-171C*	*Black=KN-171B
96 CI	FLTR Road Glide	08-09	HD-1508		RK-3946X		KN-171C*	*Black=KN-171B
96 CI	FLTR Road Glide	08-09	HD-1508		RK-3946XB		KN-171C*	*Black=KN-171B
96 CI	FLTR Road Glide	08-09	HD-1508		RK-3947		KN-171C*	*Black=KN-171B
96 CI	FLTR Road Glide	08-09	HD-1508		RK-3947B		KN-171C*	*Black=KN-171B
96 CI	FLTR Road Glide	08-09	HD-1508		RK-3947X		KN-171C*	*Black=KN-171B
96 CI	FLTR Road Glide	08-09	HD-1508		RK-3947XB		KN-171C*	*Black=KN-171B
96 CI	FLTR Road Glide	08-10	HD-1508		63-1122*	RC-3680DK	KN-171C**	*Exc. Lower Fairings/ **Black=KN-171B
96 CI	FLTR Road Glide	08-10	HD-1508		63-1122P*	RC-3680DK	KN-171C**	*Exc. Lower Fairings/ **Black=KN-171B
96 CI	FLTR Road Glide	08-10	HD-1508		63-1134*		KN-171C**	*Exc. Lower Fairings/ **Black=KN-171B
96 CI	FLTR Road Glide	08-10	HD-1508		63-1134S*		KN-171C**	*Exc. Lower Fairings/ **Black=KN-171B
96 CI	FLTR Road Glide	08-10	HD-1508		RK-3930		KN-171C*	*Black=KN-171B
96 CI	FLTR Road Glide	08-10	HD-1508		RK-3930X		KN-171C*	*Black=KN-171B
96 CI	FLTR Road Glide	08-10	HD-1508		RK-3936	RK-3901PK	KN-171C*	*Black=KN-171B
96 CI	FLTR Road Glide	08-10	HD-1508		RK-3937	RK-3902PK	KN-171C*	*Black=KN-171B
96 CI	FLTR Road Glide	08-10	HD-1508		RK-3938	RK-3901PK	KN-171C*	*Black=KN-171B
96 CI	FLTR Road Glide	08-10	HD-1508		RK-3939	RK-3902PK	KN-171C*	*Black=KN-171B
96 CI	FLTR Road Glide	08-10	HD-1508		RK-3951*		KN-171C**	*Exc. Lower Fairings/ **Black=KN-171B
96 CI	FLTR Road Glide	08-10	HD-1508		RK-3951S*		KN-171C**	*Exc. Lower Fairings/ **Black=KN-171B
96 CI	FLTRX Road Glide Custom	10-11	HD-1508		63-1122*	RC-3680DK	KN-171C**	*Exc. Lower Fairings/ **Black=KN-171B
96 CI	FLTRX Road Glide Custom	10-11	HD-1508		63-1122P*	RC-3680DK	KN-171C**	*Exc. Lower Fairings/ **Black=KN-171B
96 CI	FLTRX Road Glide Custom	10-11	HD-1508		63-1131*		KN-171C**	*w/Lower Fairings/ **Black=KN-171B
96 CI	FLTRX Road Glide Custom	10-11	HD-1508		63-1131P*		KN-171C**	*w/Lower Fairings/ **Black=KN-171B
96 CI	FLTRX Road Glide Custom	10-11	HD-1508		63-1134*		KN-171C**	*Exc. Lower Fairings/ **Black=KN-171B
96 CI	FLTRX Road Glide Custom	10-11	HD-1508		63-1134S*		KN-171C**	*Exc. Lower Fairings/ **Black=KN-171B
96 CI	FLTRX Road Glide Custom	10-11	HD-1508		RK-3930		KN-171C*	*Black=KN-171B
96 CI	FLTRX Road Glide Custom	10-11	HD-1508		RK-3930X		KN-171C*	*Black=KN-171B
96 CI	FLTRX Road Glide Custom	10-11	HD-1508		RK-3936	RK-3901PK	KN-171C*	*Black=KN-171B
96 CI	FLTRX Road Glide Custom	10-11	HD-1508		RK-3937	RK-3902PK	KN-171C*	*Black=KN-171B
96 CI	FLTRX Road Glide Custom	10-11	HD-1508		RK-3938	RK-3901PK	KN-171C*	*Black=KN-171B
96 CI	FLTRX Road Glide Custom	10-11	HD-1508		RK-3939	RK-3902PK	KN-171C*	*Black=KN-171B
96 CI	FLTRX Road Glide Custom	10-11	HD-1508		RK-3946	HD-0800DK	KN-171C*	*Black=KN-171B
96 CI	FLTRX Road Glide Custom	10-11	HD-1508		RK-3946B	HD-0800DK	KN-171C*	*Black=KN-171B
96 CI	FLTRX Road Glide Custom	10-11	HD-1508		RK-3946X		KN-171C*	*Black=KN-171B
96 CI	FLTRX Road Glide Custom	10-11	HD-1508		RK-3946XB		KN-171C*	*Black=KN-171B
96 CI	FLTRX Road Glide Custom	10-11	HD-1508		RK-3947		KN-171C*	*Black=KN-171B
96 CI	FLTRX Road Glide Custom	10-11	HD-1508		RK-3947B		KN-171C*	*Black=KN-171B
96 CI	FLTRX Road Glide Custom	10-11	HD-1508		RK-3947X		KN-171C*	*Black=KN-171B
96 CI	FLTRX Road Glide Custom	10-11	HD-1508		RK-3947XB		KN-171C*	*Black=KN-171B
96 CI	FLTRX Road Glide Custom	10-11	HD-1508		RK-3951*		KN-171C**	*Exc. Lower Fairings/ **Black=KN-171B
96 CI	FLTRX Road Glide Custom	10-11	HD-1508		RK-3951S*		KN-171C**	*Exc. Lower Fairings/ **Black=KN-171B
96 CI	FLTRXSE CVO Road Glide Custom	12-13					KN-171C*	*Black=KN-171B
96 CI	FXCW Rocker	08-09	HD-1499		63-1125*	RC-3680DK	KN-171C**	*Exc. Lower Fairings/ **Black=KN-171B
96 CI	FXCW Rocker	08-09	HD-1499		63-1125P*	RC-3680DK	KN-171C**	*Exc. Lower Fairings/ **Black=KN-171B

2) Requires Two; 3) Requires Three; 4) Requires Four. The use of custom air filter requires removal of air box. Some custom filters and intakes are not legal for sale or use on any pollution controlled motor vehicle in California or states adopting California emission procedures. See knfilters.com for CARB status on each part for a specific vehicle.



Motorcycle - Application Listing

CC	Model	Year	Air Filter	Air Filter Precharger	Custom	Custom Precharger	Oil Filter	Comments
HARLEY DAVIDSON								
96 CI	FXCW Rocker	08-09	HD-1499		63-1137*		KN-171C**	*Exc. Lower Fairings/ **Black=KN-171B
96 CI	FXCW Rocker	08-09	HD-1499		63-1137S*		KN-171C**	*Exc. Lower Fairings/ **Black=KN-171B
96 CI	FXCW Rocker	08-09	HD-1499		RK-3909-1*		KN-171C**	*w/1-5/8 inch Tall Filter/ **Black=KN-171B
96 CI	FXCW Rocker	08-09	HD-1499		RK-3910-1*		KN-171C**	*w/2-1/4 inch Tall Filter/ **Black=KN-171B
96 CI	FXCW Rocker	08-09	HD-1499		RK-3932		KN-171C*	*Black=KN-171B
96 CI	FXCW Rocker	08-09	HD-1499		RK-3932B		KN-171C*	*Black=KN-171B
96 CI	FXCW Rocker	08-09	HD-1499		RK-3932X		KN-171C*	*Black=KN-171B
96 CI	FXCW Rocker	08-09	HD-1499		RK-3932XB		KN-171C*	*Black=KN-171B
96 CI	FXCW Rocker	08-09	HD-1499		RK-3933	HD-0800DK	KN-171C*	*Black=KN-171B
96 CI	FXCW Rocker	08-09	HD-1499		RK-3933B	HD-0800DK	KN-171C*	*Black=KN-171B
96 CI	FXCW Rocker	08-09	HD-1499		RK-3933X		KN-171C*	*Black=KN-171B
96 CI	FXCW Rocker	08-09	HD-1499		RK-3933XB		KN-171C*	*Black=KN-171B
96 CI	FXCW Rocker	08-09	HD-1499		RK-3934	RK-3901PK	KN-171C*	*Black=KN-171B
96 CI	FXCW Rocker	08-09	HD-1499		RK-3935	RK-3902PK	KN-171C*	*Black=KN-171B
96 CI	FXCW Rocker	08-09	HD-1499		RK-3950*		KN-171C**	*Exc. Lower Fairings/ **Black=KN-171B
96 CI	FXCW Rocker	08-09	HD-1499		RK-3950S*		KN-171C**	*Exc. Lower Fairings/ **Black=KN-171B
96 CI	FXCWC Rocker C	08-11	HD-1499		63-1125*	RC-3680DK	KN-171C**	*Exc. Lower Fairings/ **Black=KN-171B
96 CI	FXCWC Rocker C	08-11	HD-1499		63-1125P*	RC-3680DK	KN-171C**	*Exc. Lower Fairings/ **Black=KN-171B
96 CI	FXCWC Rocker C	08-11	HD-1499		63-1137*		KN-171C**	*Exc. Lower Fairings/ **Black=KN-171B
96 CI	FXCWC Rocker C	08-11	HD-1499		63-1137S*		KN-171C**	*Exc. Lower Fairings/ **Black=KN-171B
96 CI	FXCWC Rocker C	08-11	HD-1499		RK-3909-1*		KN-171C**	*w/1-5/8 inch Tall Filter/ **Black=KN-171B
96 CI	FXCWC Rocker C	08-11	HD-1499		RK-3910-1*		KN-171C**	*w/2-1/4 inch Tall Filter/ **Black=KN-171B
96 CI	FXCWC Rocker C	08-11	HD-1499		RK-3932		KN-171C*	*Black=KN-171B
96 CI	FXCWC Rocker C	08-11	HD-1499		RK-3932B		KN-171C*	*Black=KN-171B
96 CI	FXCWC Rocker C	08-11	HD-1499		RK-3932X		KN-171C*	*Black=KN-171B
96 CI	FXCWC Rocker C	08-11	HD-1499		RK-3932XB		KN-171C*	*Black=KN-171B
96 CI	FXCWC Rocker C	08-11	HD-1499		RK-3933	HD-0800DK	KN-171C*	*Black=KN-171B
96 CI	FXCWC Rocker C	08-11	HD-1499		RK-3933B	HD-0800DK	KN-171C*	*Black=KN-171B
96 CI	FXCWC Rocker C	08-11	HD-1499		RK-3933X		KN-171C*	*Black=KN-171B
96 CI	FXCWC Rocker C	08-11	HD-1499		RK-3933XB		KN-171C*	*Black=KN-171B
96 CI	FXCWC Rocker C	08-11	HD-1499		RK-3934	RK-3901PK	KN-171C*	*Black=KN-171B
96 CI	FXCWC Rocker C	08-11	HD-1499		RK-3935	RK-3902PK	KN-171C*	*Black=KN-171B
96 CI	FXCWC Rocker C	08-11	HD-1499		RK-3950*		KN-171C**	*Exc. Lower Fairings/ **Black=KN-171B
96 CI	FXCWC Rocker C	08-11	HD-1499		RK-3950S*		KN-171C**	*Exc. Lower Fairings/ **Black=KN-171B
96 CI	FXD Dyna Super Glide	07	HD-1499		63-1125*	RC-3680DK	KN-171C**	*Exc. Lower Fairings/ **Black=KN-171B
96 CI	FXD Dyna Super Glide	07	HD-1499		63-1125P*	RC-3680DK	KN-171C**	*Exc. Lower Fairings/ **Black=KN-171B
96 CI	FXD Dyna Super Glide	07	HD-1499		63-1137*		KN-171C**	*Exc. Lower Fairings/ **Black=KN-171B
96 CI	FXD Dyna Super Glide	07	HD-1499		63-1137S*		KN-171C**	*Exc. Lower Fairings/ **Black=KN-171B
96 CI	FXD Dyna Super Glide	07	HD-1499		RK-3909-1*		KN-171C**	*w/1-5/8 inch Tall Filter/ **Black=KN-171B
96 CI	FXD Dyna Super Glide	07	HD-1499		RK-3910-1*		KN-171C**	*w/2-1/4 inch Tall Filter/ **Black=KN-171B
96 CI	FXD Dyna Super Glide	07	HD-1499		RK-3932		KN-171C*	*Black=KN-171B

2) Requires Two; 3) Requires Three; 4) Requires Four. The use of custom air filter requires removal of air box. Some custom filters and intakes are not legal for sale or use on any pollution controlled motor vehicle in California or states adopting California emission procedures. See knfilters.com for CARB status on each part for a specific vehicle.

Motorcycle - Application Listing



CC	Model	Year	Air Filter	Air Filter Precharger	Custom	Custom Precharger	Oil Filter	Comments
HARLEY DAVIDSON								
96 CI	FXD Dyna Super Glide	07	HD-1499		RK-3932B		KN-171C*	*Black=KN-171B
96 CI	FXD Dyna Super Glide	07	HD-1499		RK-3932X		KN-171C*	*Black=KN-171B
96 CI	FXD Dyna Super Glide	07	HD-1499		RK-3932XB		KN-171C*	*Black=KN-171B
96 CI	FXD Dyna Super Glide	07	HD-1499		RK-3933	HD-0800DK	KN-171C*	*Black=KN-171B
96 CI	FXD Dyna Super Glide	07	HD-1499		RK-3933B	HD-0800DK	KN-171C*	*Black=KN-171B
96 CI	FXD Dyna Super Glide	07	HD-1499		RK-3933X		KN-171C*	*Black=KN-171B
96 CI	FXD Dyna Super Glide	07	HD-1499		RK-3933XB		KN-171C*	*Black=KN-171B
96 CI	FXD Dyna Super Glide	07	HD-1499		RK-3934	RK-3901PK	KN-171C*	*Black=KN-171B
96 CI	FXD Dyna Super Glide	07	HD-1499		RK-3935	RK-3902PK	KN-171C*	*Black=KN-171B
96 CI	FXD Dyna Super Glide	07	HD-1499		RK-3950*		KN-171C**	*Exc. Lower Fairings/ **Black=KN-171B
96 CI	FXD Dyna Super Glide	07	HD-1499		RK-3950S*		KN-171C**	*Exc. Lower Fairings/ **Black=KN-171B
96 CI	FXD Dyna Super Glide	08-09	HD-9608		63-1125*	RC-3680DK	KN-171C**	*Exc. Lower Fairings/ **Black=KN-171B
96 CI	FXD Dyna Super Glide	08-09	HD-9608		63-1125P*	RC-3680DK	KN-171C**	*Exc. Lower Fairings/ **Black=KN-171B
96 CI	FXD Dyna Super Glide	08-09	HD-9608		63-1137*		KN-171C**	*Exc. Lower Fairings/ **Black=KN-171B
96 CI	FXD Dyna Super Glide	08-09	HD-9608		63-1137S*		KN-171C**	*Exc. Lower Fairings/ **Black=KN-171B
96 CI	FXD Dyna Super Glide	08-09	HD-9608		RK-3931		KN-171C*	*Black=KN-171B
96 CI	FXD Dyna Super Glide	08-09	HD-9608		RK-3932		KN-171C*	*Black=KN-171B
96 CI	FXD Dyna Super Glide	08-09	HD-9608		RK-3932B		KN-171C*	*Black=KN-171B
96 CI	FXD Dyna Super Glide	08-09	HD-9608		RK-3932X		KN-171C*	*Black=KN-171B
96 CI	FXD Dyna Super Glide	08-09	HD-9608		RK-3932XB		KN-171C*	*Black=KN-171B
96 CI	FXD Dyna Super Glide	08-09	HD-9608		RK-3933	HD-0800DK	KN-171C*	*Black=KN-171B
96 CI	FXD Dyna Super Glide	08-09	HD-9608		RK-3933B	HD-0800DK	KN-171C*	*Black=KN-171B
96 CI	FXD Dyna Super Glide	08-09	HD-9608		RK-3933X		KN-171C*	*Black=KN-171B
96 CI	FXD Dyna Super Glide	08-09	HD-9608		RK-3933XB		KN-171C*	*Black=KN-171B
96 CI	FXD Dyna Super Glide	08-09	HD-9608		RK-3934	RK-3901PK	KN-171C*	*Black=KN-171B
96 CI	FXD Dyna Super Glide	08-09	HD-9608		RK-3935	RK-3902PK	KN-171C*	*Black=KN-171B
96 CI	FXD Dyna Super Glide	08-09	HD-9608		RK-3950*		KN-171C**	*Exc. Lower Fairings/ **Black=KN-171B
96 CI	FXD Dyna Super Glide	08-09	HD-9608		RK-3950S*		KN-171C**	*Exc. Lower Fairings/ **Black=KN-171B
96 CI	FXD Dyna Super Glide	10	HD-9608		63-1125*	RC-3680DK		*Exc. Lower Fairings
96 CI	FXD Dyna Super Glide	10	HD-9608		63-1125P*	RC-3680DK		*Exc. Lower Fairings
96 CI	FXD Dyna Super Glide	10	HD-9608		63-1137*			*Exc. Lower Fairings
96 CI	FXD Dyna Super Glide	10	HD-9608		63-1137S*			*Exc. Lower Fairings
96 CI	FXD Dyna Super Glide	10	HD-9608		RK-3931			
96 CI	FXD Dyna Super Glide	10	HD-9608		RK-3932			
96 CI	FXD Dyna Super Glide	10	HD-9608		RK-3932B			
96 CI	FXD Dyna Super Glide	10	HD-9608		RK-3932X			
96 CI	FXD Dyna Super Glide	10	HD-9608		RK-3932XB			
96 CI	FXD Dyna Super Glide	10	HD-9608		RK-3933	HD-0800DK		
96 CI	FXD Dyna Super Glide	10	HD-9608		RK-3933B	HD-0800DK		
96 CI	FXD Dyna Super Glide	10	HD-9608		RK-3933X			
96 CI	FXD Dyna Super Glide	10	HD-9608		RK-3933XB			
96 CI	FXD Dyna Super Glide	10	HD-9608		RK-3934	RK-3901PK		
96 CI	FXD Dyna Super Glide	10	HD-9608		RK-3935	RK-3902PK		
96 CI	FXD Dyna Super Glide	10	HD-9608		RK-3950*			*Exc. Lower Fairings
96 CI	FXD Dyna Super Glide	10	HD-9608		RK-3950S*			*Exc. Lower Fairings
96 CI	FXDB Dyna Street Bob	07	HD-1499		63-1125*	RC-3680DK	KN-171C**	*Exc. Lower Fairings/ **Black=KN-171B
96 CI	FXDB Dyna Street Bob	07	HD-1499		63-1125P*	RC-3680DK	KN-171C**	*Exc. Lower Fairings/ **Black=KN-171B

2) Requires Two; 3) Requires Three; 4) Requires Four. The use of custom air filter requires removal of air box. Some custom filters and intakes are not legal for sale or use on any pollution controlled motor vehicle in California or states adopting California emission procedures. See knfilters.com for CARB status on each part for a specific vehicle.



Motorcycle - Application Listing

CC	Model	Year	Air Filter	Air Filter Precharger	Custom	Custom Precharger	Oil Filter	Comments
HARLEY DAVIDSON								
96 CI	FXDB Dyna Street Bob	07	HD-1499		63-1137*		KN-171C**	*Exc. Lower Fairings/ **Black=KN-171B
96 CI	FXDB Dyna Street Bob	07	HD-1499		63-1137S*		KN-171C**	*Exc. Lower Fairings/ **Black=KN-171B
96 CI	FXDB Dyna Street Bob	07	HD-1499		RK-3909-1*		KN-171C**	*w/1-5/8 inch Tall Filter/ **Black=KN-171B
96 CI	FXDB Dyna Street Bob	07	HD-1499		RK-3910-1*		KN-171C**	*w/2-1/4 inch Tall Filter/ **Black=KN-171B
96 CI	FXDB Dyna Street Bob	07	HD-1499		RK-3932		KN-171C*	*Black=KN-171B
96 CI	FXDB Dyna Street Bob	07	HD-1499		RK-3932B		KN-171C*	*Black=KN-171B
96 CI	FXDB Dyna Street Bob	07	HD-1499		RK-3932X		KN-171C*	*Black=KN-171B
96 CI	FXDB Dyna Street Bob	07	HD-1499		RK-3932XB		KN-171C*	*Black=KN-171B
96 CI	FXDB Dyna Street Bob	07	HD-1499		RK-3933	HD-0800DK	KN-171C*	*Black=KN-171B
96 CI	FXDB Dyna Street Bob	07	HD-1499		RK-3933B	HD-0800DK	KN-171C*	*Black=KN-171B
96 CI	FXDB Dyna Street Bob	07	HD-1499		RK-3933X		KN-171C*	*Black=KN-171B
96 CI	FXDB Dyna Street Bob	07	HD-1499		RK-3933XB		KN-171C*	*Black=KN-171B
96 CI	FXDB Dyna Street Bob	07	HD-1499		RK-3934	RK-3901PK	KN-171C*	*Black=KN-171B
96 CI	FXDB Dyna Street Bob	07	HD-1499		RK-3935	RK-3902PK	KN-171C*	*Black=KN-171B
96 CI	FXDB Dyna Street Bob	07	HD-1499		RK-3950*		KN-171C**	*Exc. Lower Fairings/ **Black=KN-171B
96 CI	FXDB Dyna Street Bob	07	HD-1499		RK-3950S*		KN-171C**	*Exc. Lower Fairings/ **Black=KN-171B
96 CI	FXDB Dyna Street Bob	08-12	HD-9608		RK-3931		KN-171C*	*Black=KN-171B
96 CI	FXDB Dyna Street Bob	08-13	HD-9608		63-1125*	RC-3680DK	KN-171C**	*Exc. Lower Fairings/ **Black=KN-171B
96 CI	FXDB Dyna Street Bob	08-13	HD-9608		63-1125P*	RC-3680DK	KN-171C**	*Exc. Lower Fairings/ **Black=KN-171B
96 CI	FXDB Dyna Street Bob	08-13	HD-9608		63-1137*		KN-171C**	*Exc. Lower Fairings/ **Black=KN-171B
96 CI	FXDB Dyna Street Bob	08-13	HD-9608		63-1137S*		KN-171C**	*Exc. Lower Fairings/ **Black=KN-171B
96 CI	FXDB Dyna Street Bob	08-13	HD-9608		RK-3932		KN-171C*	*Black=KN-171B
96 CI	FXDB Dyna Street Bob	08-13	HD-9608		RK-3932B		KN-171C*	*Black=KN-171B
96 CI	FXDB Dyna Street Bob	08-13	HD-9608		RK-3932X		KN-171C*	*Black=KN-171B
96 CI	FXDB Dyna Street Bob	08-13	HD-9608		RK-3932XB		KN-171C*	*Black=KN-171B
96 CI	FXDB Dyna Street Bob	08-13	HD-9608		RK-3933	HD-0800DK	KN-171C*	*Black=KN-171B
96 CI	FXDB Dyna Street Bob	08-13	HD-9608		RK-3933B	HD-0800DK	KN-171C*	*Black=KN-171B
96 CI	FXDB Dyna Street Bob	08-13	HD-9608		RK-3933X		KN-171C*	*Black=KN-171B
96 CI	FXDB Dyna Street Bob	08-13	HD-9608		RK-3933XB		KN-171C*	*Black=KN-171B
96 CI	FXDB Dyna Street Bob	08-13	HD-9608		RK-3934	RK-3901PK	KN-171C*	*Black=KN-171B
96 CI	FXDB Dyna Street Bob	08-13	HD-9608		RK-3935	RK-3902PK	KN-171C*	*Black=KN-171B
96 CI	FXDB Dyna Street Bob	08-13	HD-9608		RK-3950*		KN-171C**	*Exc. Lower Fairings/ **Black=KN-171B
96 CI	FXDB Dyna Street Bob	08-13	HD-9608		RK-3950S*		KN-171C**	*Exc. Lower Fairings/ **Black=KN-171B
96 CI	FXDC Dyna Super Glide Custom	09-13	HD-9608		63-1125*	RC-3680DK	KN-171C**	*Exc. Lower Fairings/ **Black=KN-171B
96 CI	FXDC Dyna Super Glide Custom	09-13	HD-9608		63-1125P*	RC-3680DK	KN-171C**	*Exc. Lower Fairings/ **Black=KN-171B
96 CI	FXDC Dyna Super Glide Custom	09-13	HD-9608		63-1137*		KN-171C**	*Exc. Lower Fairings/ **Black=KN-171B
96 CI	FXDC Dyna Super Glide Custom	09-13	HD-9608		63-1137S*		KN-171C**	*Exc. Lower Fairings/ **Black=KN-171B
96 CI	FXDC Dyna Super Glide Custom	09-13	HD-9608		RK-3931		KN-171C*	*Black=KN-171B
96 CI	FXDC Dyna Super Glide Custom	09-13	HD-9608		RK-3932		KN-171C*	*Black=KN-171B
96 CI	FXDC Dyna Super Glide Custom	09-13	HD-9608		RK-3932B		KN-171C*	*Black=KN-171B
96 CI	FXDC Dyna Super Glide Custom	09-13	HD-9608		RK-3932X		KN-171C*	*Black=KN-171B
96 CI	FXDC Dyna Super Glide Custom	09-13	HD-9608		RK-3932XB		KN-171C*	*Black=KN-171B
96 CI	FXDC Dyna Super Glide Custom	09-13	HD-9608		RK-3933	HD-0800DK	KN-171C*	*Black=KN-171B
96 CI	FXDC Dyna Super Glide Custom	09-13	HD-9608		RK-3933B	HD-0800DK	KN-171C*	*Black=KN-171B

2) Requires Two; 3) Requires Three; 4) Requires Four. The use of custom air filter requires removal of air box. Some custom filters and intakes are not legal for sale or use on any pollution controlled motor vehicle in California or states adopting California emission procedures. See knfilters.com for CARB status on each part for a specific vehicle.

Motorcycle - Application Listing



CC	Model	Year	Air Filter	Air Filter Precharger	Custom	Custom Precharger	Oil Filter	Comments
HARLEY DAVIDSON								
96 CI	FXDC Dyna Super Glide Custom	09-13	HD-9608		RK-3933X		KN-171C*	*Black=KN-171B
96 CI	FXDC Dyna Super Glide Custom	09-13	HD-9608		RK-3933XB		KN-171C*	*Black=KN-171B
96 CI	FXDC Dyna Super Glide Custom	09-13	HD-9608		RK-3934	RK-3901PK	KN-171C*	*Black=KN-171B
96 CI	FXDC Dyna Super Glide Custom	09-13	HD-9608		RK-3935	RK-3902PK	KN-171C*	*Black=KN-171B
96 CI	FXDC Dyna Super Glide Custom	09-13	HD-9608		RK-3950*		KN-171C**	*Exc. Lower Fairings/ **Black=KN-171B
96 CI	FXDC Dyna Super Glide Custom	09-13	HD-9608		RK-3950S*		KN-171C**	*Exc. Lower Fairings/ **Black=KN-171B
96 CI	FXDC Super Glide Custom	07	HD-1499		63-1125*	RC-3680DK	KN-171C**	*Exc. Lower Fairings/ **Black=KN-171B
96 CI	FXDC Super Glide Custom	07	HD-1499		63-1125P*	RC-3680DK	KN-171C**	*Exc. Lower Fairings/ **Black=KN-171B
96 CI	FXDC Super Glide Custom	07	HD-1499		63-1137*		KN-171C**	*Exc. Lower Fairings/ **Black=KN-171B
96 CI	FXDC Super Glide Custom	07	HD-1499		63-1137S*		KN-171C**	*Exc. Lower Fairings/ **Black=KN-171B
96 CI	FXDC Super Glide Custom	07	HD-1499		RK-3909-1*		KN-171C**	*w/1-5/8 inch Tall Filter/ **Black=KN-171B
96 CI	FXDC Super Glide Custom	07	HD-1499		RK-3910-1*		KN-171C**	*w/2-1/4 inch Tall Filter/ **Black=KN-171B
96 CI	FXDC Super Glide Custom	07	HD-1499		RK-3932		KN-171C*	*Black=KN-171B
96 CI	FXDC Super Glide Custom	07	HD-1499		RK-3932B		KN-171C*	*Black=KN-171B
96 CI	FXDC Super Glide Custom	07	HD-1499		RK-3932X		KN-171C*	*Black=KN-171B
96 CI	FXDC Super Glide Custom	07	HD-1499		RK-3932XB		KN-171C*	*Black=KN-171B
96 CI	FXDC Super Glide Custom	07	HD-1499		RK-3933	HD-0800DK	KN-171C*	*Black=KN-171B
96 CI	FXDC Super Glide Custom	07	HD-1499		RK-3933B	HD-0800DK	KN-171C*	*Black=KN-171B
96 CI	FXDC Super Glide Custom	07	HD-1499		RK-3933X		KN-171C*	*Black=KN-171B
96 CI	FXDC Super Glide Custom	07	HD-1499		RK-3933XB		KN-171C*	*Black=KN-171B
96 CI	FXDC Super Glide Custom	07	HD-1499		RK-3934	RK-3901PK	KN-171C*	*Black=KN-171B
96 CI	FXDC Super Glide Custom	07	HD-1499		RK-3935	RK-3902PK	KN-171C*	*Black=KN-171B
96 CI	FXDC Super Glide Custom	07	HD-1499		RK-3950*		KN-171C**	*Exc. Lower Fairings/ **Black=KN-171B
96 CI	FXDC Super Glide Custom	07	HD-1499		RK-3950S*		KN-171C**	*Exc. Lower Fairings/ **Black=KN-171B
96 CI	FXDC Super Glide Custom	08	HD-9608		63-1125*	RC-3680DK	KN-171C**	*Exc. Lower Fairings/ **Black=KN-171B
96 CI	FXDC Super Glide Custom	08	HD-9608		63-1125P*	RC-3680DK	KN-171C**	*Exc. Lower Fairings/ **Black=KN-171B
96 CI	FXDC Super Glide Custom	08	HD-9608		63-1137*		KN-171C**	*Exc. Lower Fairings/ **Black=KN-171B
96 CI	FXDC Super Glide Custom	08	HD-9608		63-1137S*		KN-171C**	*Exc. Lower Fairings/ **Black=KN-171B
96 CI	FXDC Super Glide Custom	08	HD-9608		RK-3931		KN-171C*	*Black=KN-171B
96 CI	FXDC Super Glide Custom	08	HD-9608		RK-3932		KN-171C*	*Black=KN-171B
96 CI	FXDC Super Glide Custom	08	HD-9608		RK-3932B		KN-171C*	*Black=KN-171B
96 CI	FXDC Super Glide Custom	08	HD-9608		RK-3932X		KN-171C*	*Black=KN-171B
96 CI	FXDC Super Glide Custom	08	HD-9608		RK-3932XB		KN-171C*	*Black=KN-171B
96 CI	FXDC Super Glide Custom	08	HD-9608		RK-3933	HD-0800DK	KN-171C*	*Black=KN-171B
96 CI	FXDC Super Glide Custom	08	HD-9608		RK-3933B	HD-0800DK	KN-171C*	*Black=KN-171B
96 CI	FXDC Super Glide Custom	08	HD-9608		RK-3933X		KN-171C*	*Black=KN-171B
96 CI	FXDC Super Glide Custom	08	HD-9608		RK-3933XB		KN-171C*	*Black=KN-171B
96 CI	FXDC Super Glide Custom	08	HD-9608		RK-3934	RK-3901PK	KN-171C*	*Black=KN-171B
96 CI	FXDC Super Glide Custom	08	HD-9608		RK-3935	RK-3902PK	KN-171C*	*Black=KN-171B
96 CI	FXDC Super Glide Custom	08	HD-9608		RK-3950*		KN-171C**	*Exc. Lower Fairings/ **Black=KN-171B
96 CI	FXDC Super Glide Custom	08	HD-9608		RK-3950S*		KN-171C**	*Exc. Lower Fairings/ **Black=KN-171B
96 CI	FXDC Super Glide Custom	13	HD-9608		63-1125*	RC-3680DK	KN-171C**	*Exc. Lower Fairings/ **Black=KN-171B

2) Requires Two; 3) Requires Three; 4) Requires Four. The use of custom air filter requires removal of air box. Some custom filters and intakes are not legal for sale or use on any pollution controlled motor vehicle in California or states adopting California emission procedures. See knfilters.com for CARB status on each part for a specific vehicle.



Motorcycle - Application Listing

CC	Model	Year	Air Filter	Air Filter Precharger	Custom	Custom Precharger	Oil Filter	Comments
HARLEY DAVIDSON								
96 CI	FXDC Super Glide Custom	13	HD-9608		63-1125P*	RC-3680DK	KN-171C**	*Exc. Lower Fairings/ **Black=KN-171B
96 CI	FXDC Super Glide Custom	13	HD-9608		63-1137*		KN-171C**	*Exc. Lower Fairings/ **Black=KN-171B
96 CI	FXDC Super Glide Custom	13	HD-9608		63-1137S*		KN-171C**	*Exc. Lower Fairings/ **Black=KN-171B
96 CI	FXDC Super Glide Custom	13	HD-9608		RK-3950*		KN-171C**	*Exc. Lower Fairings/ **Black=KN-171B
96 CI	FXDC Super Glide Custom	13	HD-9608		RK-3950S*		KN-171C**	*Exc. Lower Fairings/ **Black=KN-171B
96 CI	FXDF Fat Bob	08-11	HD-9608		63-1125*	RC-3680DK	KN-171C**	*Exc. Lower Fairings/ **Black=KN-171B
96 CI	FXDF Fat Bob	08-11	HD-9608		63-1125P*	RC-3680DK	KN-171C**	*Exc. Lower Fairings/ **Black=KN-171B
96 CI	FXDF Fat Bob	08-11	HD-9608		63-1137*		KN-171C**	*Exc. Lower Fairings/ **Black=KN-171B
96 CI	FXDF Fat Bob	08-11	HD-9608		63-1137S*		KN-171C**	*Exc. Lower Fairings/ **Black=KN-171B
96 CI	FXDF Fat Bob	08-11	HD-9608		RK-3931		KN-171C*	*Black=KN-171B
96 CI	FXDF Fat Bob	08-11	HD-9608		RK-3932		KN-171C*	*Black=KN-171B
96 CI	FXDF Fat Bob	08-11	HD-9608		RK-3932B		KN-171C*	*Black=KN-171B
96 CI	FXDF Fat Bob	08-11	HD-9608		RK-3932X		KN-171C*	*Black=KN-171B
96 CI	FXDF Fat Bob	08-11	HD-9608		RK-3932XB		KN-171C*	*Black=KN-171B
96 CI	FXDF Fat Bob	08-11	HD-9608		RK-3933	HD-0800DK	KN-171C*	*Black=KN-171B
96 CI	FXDF Fat Bob	08-11	HD-9608		RK-3933B	HD-0800DK	KN-171C*	*Black=KN-171B
96 CI	FXDF Fat Bob	08-11	HD-9608		RK-3933X		KN-171C*	*Black=KN-171B
96 CI	FXDF Fat Bob	08-11	HD-9608		RK-3933XB		KN-171C*	*Black=KN-171B
96 CI	FXDF Fat Bob	08-11	HD-9608		RK-3934	RK-3901PK	KN-171C*	*Black=KN-171B
96 CI	FXDF Fat Bob	08-11	HD-9608		RK-3935	RK-3902PK	KN-171C*	*Black=KN-171B
96 CI	FXDF Fat Bob	08-11	HD-9608		RK-3950*		KN-171C**	*Exc. Lower Fairings/ **Black=KN-171B
96 CI	FXDF Fat Bob	08-11	HD-9608		RK-3950S*		KN-171C**	*Exc. Lower Fairings/ **Black=KN-171B
96 CI	FXDFSE2 CVO Dyna Fat Bob	10					KN-171C*	*Black=KN-171B
96 CI	FXDL Dyna Low Rider	07	HD-1499		63-1125*	RC-3680DK	KN-171C**	*Exc. Lower Fairings/ **Black=KN-171B
96 CI	FXDL Dyna Low Rider	07	HD-1499		63-1125P*	RC-3680DK	KN-171C**	*Exc. Lower Fairings/ **Black=KN-171B
96 CI	FXDL Dyna Low Rider	07	HD-1499		63-1137*		KN-171C**	*Exc. Lower Fairings/ **Black=KN-171B
96 CI	FXDL Dyna Low Rider	07	HD-1499		63-1137S*		KN-171C**	*Exc. Lower Fairings/ **Black=KN-171B
96 CI	FXDL Dyna Low Rider	07	HD-1499		RK-3909-1*		KN-171C**	*w/1-5/8 inch Tall Filter/ **Black=KN-171B
96 CI	FXDL Dyna Low Rider	07	HD-1499		RK-3910-1*		KN-171C**	*w/2-1/4 inch Tall Filter/ **Black=KN-171B
96 CI	FXDL Dyna Low Rider	07	HD-1499		RK-3932		KN-171C*	*Black=KN-171B
96 CI	FXDL Dyna Low Rider	07	HD-1499		RK-3932B		KN-171C*	*Black=KN-171B
96 CI	FXDL Dyna Low Rider	07	HD-1499		RK-3932X		KN-171C*	*Black=KN-171B
96 CI	FXDL Dyna Low Rider	07	HD-1499		RK-3932XB		KN-171C*	*Black=KN-171B
96 CI	FXDL Dyna Low Rider	07	HD-1499		RK-3933	HD-0800DK	KN-171C*	*Black=KN-171B
96 CI	FXDL Dyna Low Rider	07	HD-1499		RK-3933B	HD-0800DK	KN-171C*	*Black=KN-171B
96 CI	FXDL Dyna Low Rider	07	HD-1499		RK-3933X		KN-171C*	*Black=KN-171B
96 CI	FXDL Dyna Low Rider	07	HD-1499		RK-3933XB		KN-171C*	*Black=KN-171B
96 CI	FXDL Dyna Low Rider	07	HD-1499		RK-3934	RK-3901PK	KN-171C*	*Black=KN-171B
96 CI	FXDL Dyna Low Rider	07	HD-1499		RK-3935	RK-3902PK	KN-171C*	*Black=KN-171B
96 CI	FXDL Dyna Low Rider	07	HD-1499		RK-3950*		KN-171C**	*Exc. Lower Fairings/ **Black=KN-171B
96 CI	FXDL Dyna Low Rider	07	HD-1499		RK-3950S*		KN-171C**	*Exc. Lower Fairings/ **Black=KN-171B

2) Requires Two; 3) Requires Three; 4) Requires Four. The use of custom air filter requires removal of air box. Some custom filters and intakes are not legal for sale or use on any pollution controlled motor vehicle in California or states adopting California emission procedures. See knfilters.com for CARB status on each part for a specific vehicle.

Motorcycle - Application Listing



CC	Model	Year	Air Filter	Air Filter Precharger	Custom	Custom Precharger	Oil Filter	Comments
HARLEY DAVIDSON								
96 CI	FXDL Dyna Low Rider	08-09	HD-9608		63-1125*	RC-3680DK	KN-171C**	*Exc. Lower Fairings/ **Black=KN-171B
96 CI	FXDL Dyna Low Rider	08-09	HD-9608		63-1125P*	RC-3680DK	KN-171C**	*Exc. Lower Fairings/ **Black=KN-171B
96 CI	FXDL Dyna Low Rider	08-09	HD-9608		63-1137*		KN-171C**	*Exc. Lower Fairings/ **Black=KN-171B
96 CI	FXDL Dyna Low Rider	08-09	HD-9608		63-1137S*		KN-171C**	*Exc. Lower Fairings/ **Black=KN-171B
96 CI	FXDL Dyna Low Rider	08-09	HD-9608		RK-3931		KN-171C*	*Black=KN-171B
96 CI	FXDL Dyna Low Rider	08-09	HD-9608		RK-3932		KN-171C*	*Black=KN-171B
96 CI	FXDL Dyna Low Rider	08-09	HD-9608		RK-3932B		KN-171C*	*Black=KN-171B
96 CI	FXDL Dyna Low Rider	08-09	HD-9608		RK-3932X		KN-171C*	*Black=KN-171B
96 CI	FXDL Dyna Low Rider	08-09	HD-9608		RK-3932XB		KN-171C*	*Black=KN-171B
96 CI	FXDL Dyna Low Rider	08-09	HD-9608		RK-3933	HD-0800DK	KN-171C*	*Black=KN-171B
96 CI	FXDL Dyna Low Rider	08-09	HD-9608		RK-3933B	HD-0800DK	KN-171C*	*Black=KN-171B
96 CI	FXDL Dyna Low Rider	08-09	HD-9608		RK-3933X		KN-171C*	*Black=KN-171B
96 CI	FXDL Dyna Low Rider	08-09	HD-9608		RK-3933XB		KN-171C*	*Black=KN-171B
96 CI	FXDL Dyna Low Rider	08-09	HD-9608		RK-3934	RK-3901PK	KN-171C*	*Black=KN-171B
96 CI	FXDL Dyna Low Rider	08-09	HD-9608		RK-3935	RK-3902PK	KN-171C*	*Black=KN-171B
96 CI	FXDL Dyna Low Rider	08-09	HD-9608		RK-3950*		KN-171C**	*Exc. Lower Fairings/ **Black=KN-171B
96 CI	FXDL Dyna Low Rider	08-09	HD-9608		RK-3950S*		KN-171C**	*Exc. Lower Fairings/ **Black=KN-171B
96 CI	FXDL Dyna Low Rider	10	HD-9608*					*Japan
96 CI	FXDWG Dyna Wide Glide	07	HD-1499		63-1125*	RC-3680DK	KN-171C**	*Exc. Lower Fairings/ **Black=KN-171B
96 CI	FXDWG Dyna Wide Glide	07	HD-1499		63-1125P*	RC-3680DK	KN-171C**	*Exc. Lower Fairings/ **Black=KN-171B
96 CI	FXDWG Dyna Wide Glide	07	HD-1499		63-1137*		KN-171C**	*Exc. Lower Fairings/ **Black=KN-171B
96 CI	FXDWG Dyna Wide Glide	07	HD-1499		63-1137S*		KN-171C**	*Exc. Lower Fairings/ **Black=KN-171B
96 CI	FXDWG Dyna Wide Glide	07	HD-1499		RK-3909-1*		KN-171C**	*w/1-5/8 inch Tall Filter/ **Black=KN-171B
96 CI	FXDWG Dyna Wide Glide	07	HD-1499		RK-3910-1*		KN-171C**	*w/2-1/4 inch Tall Filter/ **Black=KN-171B
96 CI	FXDWG Dyna Wide Glide	07	HD-1499		RK-3932		KN-171C*	*Black=KN-171B
96 CI	FXDWG Dyna Wide Glide	07	HD-1499		RK-3932B		KN-171C*	*Black=KN-171B
96 CI	FXDWG Dyna Wide Glide	07	HD-1499		RK-3932X		KN-171C*	*Black=KN-171B
96 CI	FXDWG Dyna Wide Glide	07	HD-1499		RK-3932XB		KN-171C*	*Black=KN-171B
96 CI	FXDWG Dyna Wide Glide	07	HD-1499		RK-3933	HD-0800DK	KN-171C*	*Black=KN-171B
96 CI	FXDWG Dyna Wide Glide	07	HD-1499		RK-3933B	HD-0800DK	KN-171C*	*Black=KN-171B
96 CI	FXDWG Dyna Wide Glide	07	HD-1499		RK-3933X		KN-171C*	*Black=KN-171B
96 CI	FXDWG Dyna Wide Glide	07	HD-1499		RK-3933XB		KN-171C*	*Black=KN-171B
96 CI	FXDWG Dyna Wide Glide	07	HD-1499		RK-3934	RK-3901PK	KN-171C*	*Black=KN-171B
96 CI	FXDWG Dyna Wide Glide	07	HD-1499		RK-3935	RK-3902PK	KN-171C*	*Black=KN-171B
96 CI	FXDWG Dyna Wide Glide	07	HD-1499		RK-3950*		KN-171C**	*Exc. Lower Fairings/ **Black=KN-171B
96 CI	FXDWG Dyna Wide Glide	07	HD-1499		RK-3950S*		KN-171C**	*Exc. Lower Fairings/ **Black=KN-171B
96 CI	FXDWG Dyna Wide Glide	08	HD-9608		63-1125*	RC-3680DK	KN-171C**	*Exc. Lower Fairings/ **Black=KN-171B
96 CI	FXDWG Dyna Wide Glide	08	HD-9608		63-1125P*	RC-3680DK	KN-171C**	*Exc. Lower Fairings/ **Black=KN-171B
96 CI	FXDWG Dyna Wide Glide	08	HD-9608		63-1137*		KN-171C**	*Exc. Lower Fairings/ **Black=KN-171B
96 CI	FXDWG Dyna Wide Glide	08	HD-9608		63-1137S*		KN-171C**	*Exc. Lower Fairings/ **Black=KN-171B
96 CI	FXDWG Dyna Wide Glide	08	HD-9608		RK-3931		KN-171C*	*Black=KN-171B
96 CI	FXDWG Dyna Wide Glide	08	HD-9608		RK-3932		KN-171C*	*Black=KN-171B

2) Requires Two; 3) Requires Three; 4) Requires Four. The use of custom air filter requires removal of air box. Some custom filters and intakes are not legal for sale or use on any pollution controlled motor vehicle in California or states adopting California emission procedures. See knfilters.com for CARB status on each part for a specific vehicle.



Motorcycle - Application Listing

CC	Model	Year	Air Filter	Air Filter Precharger	Custom	Custom Precharger	Oil Filter	Comments
HARLEY DAVIDSON								
96 CI	FXDWG Dyna Wide Glide	08	HD-9608		RK-3932B		KN-171C*	*Black=KN-171B
96 CI	FXDWG Dyna Wide Glide	08	HD-9608		RK-3932X		KN-171C*	*Black=KN-171B
96 CI	FXDWG Dyna Wide Glide	08	HD-9608		RK-3932XB		KN-171C*	*Black=KN-171B
96 CI	FXDWG Dyna Wide Glide	08	HD-9608		RK-3933	HD-0800DK	KN-171C*	*Black=KN-171B
96 CI	FXDWG Dyna Wide Glide	08	HD-9608		RK-3933B	HD-0800DK	KN-171C*	*Black=KN-171B
96 CI	FXDWG Dyna Wide Glide	08	HD-9608		RK-3933X		KN-171C*	*Black=KN-171B
96 CI	FXDWG Dyna Wide Glide	08	HD-9608		RK-3933XB		KN-171C*	*Black=KN-171B
96 CI	FXDWG Dyna Wide Glide	08	HD-9608		RK-3934	RK-3901PK	KN-171C*	*Black=KN-171B
96 CI	FXDWG Dyna Wide Glide	08	HD-9608		RK-3935	RK-3902PK	KN-171C*	*Black=KN-171B
96 CI	FXDWG Dyna Wide Glide	08	HD-9608		RK-3950*		KN-171C**	*Exc. Lower Fairings/ **Black=KN-171B
96 CI	FXDWG Dyna Wide Glide	08	HD-9608		RK-3950S*		KN-171C**	*Exc. Lower Fairings/ **Black=KN-171B
96 CI	FXDWG Dyna Wide Glide	10-11	HD-9608		63-1125*	RC-3680DK	KN-171C**	*Exc. Lower Fairings/ **Black=KN-171B
96 CI	FXDWG Dyna Wide Glide	10-11	HD-9608		63-1125P*	RC-3680DK	KN-171C**	*Exc. Lower Fairings/ **Black=KN-171B
96 CI	FXDWG Dyna Wide Glide	10-11	HD-9608		63-1137*		KN-171C**	*Exc. Lower Fairings/ **Black=KN-171B
96 CI	FXDWG Dyna Wide Glide	10-11	HD-9608		63-1137S*		KN-171C**	*Exc. Lower Fairings/ **Black=KN-171B
96 CI	FXDWG Dyna Wide Glide	10-11	HD-9608		RK-3931		KN-171C*	*Black=KN-171B
96 CI	FXDWG Dyna Wide Glide	10-11	HD-9608		RK-3932		KN-171C*	*Black=KN-171B
96 CI	FXDWG Dyna Wide Glide	10-11	HD-9608		RK-3932B		KN-171C*	*Black=KN-171B
96 CI	FXDWG Dyna Wide Glide	10-11	HD-9608		RK-3932X		KN-171C*	*Black=KN-171B
96 CI	FXDWG Dyna Wide Glide	10-11	HD-9608		RK-3932XB		KN-171C*	*Black=KN-171B
96 CI	FXDWG Dyna Wide Glide	10-11	HD-9608		RK-3933	HD-0800DK	KN-171C*	*Black=KN-171B
96 CI	FXDWG Dyna Wide Glide	10-11	HD-9608		RK-3933B	HD-0800DK	KN-171C*	*Black=KN-171B
96 CI	FXDWG Dyna Wide Glide	10-11	HD-9608		RK-3933X		KN-171C*	*Black=KN-171B
96 CI	FXDWG Dyna Wide Glide	10-11	HD-9608		RK-3933XB		KN-171C*	*Black=KN-171B
96 CI	FXDWG Dyna Wide Glide	10-11	HD-9608		RK-3934	RK-3901PK	KN-171C*	*Black=KN-171B
96 CI	FXDWG Dyna Wide Glide	10-11	HD-9608		RK-3935	RK-3902PK	KN-171C*	*Black=KN-171B
96 CI	FXDWG Dyna Wide Glide	10-11	HD-9608		RK-3950*		KN-171C**	*Exc. Lower Fairings/ **Black=KN-171B
96 CI	FXDWG Dyna Wide Glide	10-11	HD-9608		RK-3950S*		KN-171C**	*Exc. Lower Fairings/ **Black=KN-171B
96 CI	FXST Softail Standard	07	HD-1499		63-1125*	RC-3680DK	KN-171C**	*Exc. Lower Fairings/ **Black=KN-171B
96 CI	FXST Softail Standard	07	HD-1499		63-1125P*	RC-3680DK	KN-171C**	*Exc. Lower Fairings/ **Black=KN-171B
96 CI	FXST Softail Standard	07	HD-1499		63-1137*		KN-171C**	*Exc. Lower Fairings/ **Black=KN-171B
96 CI	FXST Softail Standard	07	HD-1499		63-1137S*		KN-171C**	*Exc. Lower Fairings/ **Black=KN-171B
96 CI	FXST Softail Standard	07	HD-1499		RK-3909-1*		KN-171C**	*w/1-5/8 inch Tall Filter/ **Black=KN-171B
96 CI	FXST Softail Standard	07	HD-1499		RK-3910-1*		KN-171C**	*w/2-1/4 inch Tall Filter/ **Black=KN-171B
96 CI	FXST Softail Standard	07	HD-1499		RK-3932		KN-171C*	*Black=KN-171B
96 CI	FXST Softail Standard	07	HD-1499		RK-3932B		KN-171C*	*Black=KN-171B
96 CI	FXST Softail Standard	07	HD-1499		RK-3932X		KN-171C*	*Black=KN-171B
96 CI	FXST Softail Standard	07	HD-1499		RK-3932XB		KN-171C*	*Black=KN-171B
96 CI	FXST Softail Standard	07	HD-1499		RK-3933	HD-0800DK	KN-171C*	*Black=KN-171B
96 CI	FXST Softail Standard	07	HD-1499		RK-3933B	HD-0800DK	KN-171C*	*Black=KN-171B
96 CI	FXST Softail Standard	07	HD-1499		RK-3933X		KN-171C*	*Black=KN-171B
96 CI	FXST Softail Standard	07	HD-1499		RK-3933XB		KN-171C*	*Black=KN-171B
96 CI	FXST Softail Standard	07	HD-1499		RK-3934	RK-3901PK	KN-171C*	*Black=KN-171B
96 CI	FXST Softail Standard	07	HD-1499		RK-3935	RK-3902PK	KN-171C*	*Black=KN-171B

2) Requires Two; 3) Requires Three; 4) Requires Four. The use of custom air filter requires removal of air box. Some custom filters and intakes are not legal for sale or use on any pollution controlled motor vehicle in California or states adopting California emission procedures. See knfilters.com for CARB status on each part for a specific vehicle.

Motorcycle - Application Listing



CC	Model	Year	Air Filter	Air Filter Precharger	Custom	Custom Precharger	Oil Filter	Comments
HARLEY DAVIDSON								
96 CI	FXST Softail Standard	07	HD-1499		RK-3950*		KN-171C**	*Exc. Lower Fairings/ **Black=KN-171B
96 CI	FXST Softail Standard	07	HD-1499		RK-3950S*		KN-171C**	*Exc. Lower Fairings/ **Black=KN-171B
96 CI	FXSTB Night Train	07-09	HD-1499		63-1125*	RC-3680DK	KN-171C**	*Exc. Lower Fairings/ **Black=KN-171B
96 CI	FXSTB Night Train	07-09	HD-1499		63-1125P*	RC-3680DK	KN-171C**	*Exc. Lower Fairings/ **Black=KN-171B
96 CI	FXSTB Night Train	07-09	HD-1499		63-1137*		KN-171C**	*Exc. Lower Fairings/ **Black=KN-171B
96 CI	FXSTB Night Train	07-09	HD-1499		63-1137S*		KN-171C**	*Exc. Lower Fairings/ **Black=KN-171B
96 CI	FXSTB Night Train	07-09	HD-1499		RK-3909-1*		KN-171C**	*w/1-5/8 inch Tall Filter/ **Black=KN-171B
96 CI	FXSTB Night Train	07-09	HD-1499		RK-3910-1*		KN-171C**	*w/2-1/4 inch Tall Filter/ **Black=KN-171B
96 CI	FXSTB Night Train	07-09	HD-1499		RK-3932		KN-171C*	*Black=KN-171B
96 CI	FXSTB Night Train	07-09	HD-1499		RK-3932B		KN-171C*	*Black=KN-171B
96 CI	FXSTB Night Train	07-09	HD-1499		RK-3932X		KN-171C*	*Black=KN-171B
96 CI	FXSTB Night Train	07-09	HD-1499		RK-3932XB		KN-171C*	*Black=KN-171B
96 CI	FXSTB Night Train	07-09	HD-1499		RK-3933	HD-0800DK	KN-171C*	*Black=KN-171B
96 CI	FXSTB Night Train	07-09	HD-1499		RK-3933B	HD-0800DK	KN-171C*	*Black=KN-171B
96 CI	FXSTB Night Train	07-09	HD-1499		RK-3933X		KN-171C*	*Black=KN-171B
96 CI	FXSTB Night Train	07-09	HD-1499		RK-3933XB		KN-171C*	*Black=KN-171B
96 CI	FXSTB Night Train	07-09	HD-1499		RK-3934	RK-3901PK	KN-171C*	*Black=KN-171B
96 CI	FXSTB Night Train	07-09	HD-1499		RK-3935	RK-3902PK	KN-171C*	*Black=KN-171B
96 CI	FXSTB Night Train	07-09	HD-1499		RK-3950*		KN-171C**	*Exc. Lower Fairings/ **Black=KN-171B
96 CI	FXSTB Night Train	07-09	HD-1499		RK-3950S*		KN-171C**	*Exc. Lower Fairings/ **Black=KN-171B
96 CI	FXSTB Night Train	10			63-1125*	RC-3680DK		*Exc. Lower Fairings
96 CI	FXSTB Night Train	10			63-1125P*	RC-3680DK		*Exc. Lower Fairings
96 CI	FXSTB Night Train	10			63-1137*			*Exc. Lower Fairings
96 CI	FXSTB Night Train	10			63-1137S*			*Exc. Lower Fairings
96 CI	FXSTB Night Train	10			RK-3909-1*			*w/1-5/8 inch Tall Filter
96 CI	FXSTB Night Train	10			RK-3910-1*			*w/2-1/4 inch Tall Filter
96 CI	FXSTB Night Train	10			RK-3950*			*Exc. Lower Fairings
96 CI	FXSTB Night Train	10			RK-3950S*			*Exc. Lower Fairings
96 CI	FXSTC Softail Custom	07-10	HD-1499		63-1125*	RC-3680DK	KN-171C**	*Exc. Lower Fairings/ **Black=KN-171B
96 CI	FXSTC Softail Custom	07-10	HD-1499		63-1125P*	RC-3680DK	KN-171C**	*Exc. Lower Fairings/ **Black=KN-171B
96 CI	FXSTC Softail Custom	07-10	HD-1499		63-1137*		KN-171C**	*Exc. Lower Fairings/ **Black=KN-171B
96 CI	FXSTC Softail Custom	07-10	HD-1499		63-1137S*		KN-171C**	*Exc. Lower Fairings/ **Black=KN-171B
96 CI	FXSTC Softail Custom	07-10	HD-1499		RK-3909-1*		KN-171C**	*w/1-5/8 inch Tall Filter/ **Black=KN-171B
96 CI	FXSTC Softail Custom	07-10	HD-1499		RK-3910-1*		KN-171C**	*w/2-1/4 inch Tall Filter/ **Black=KN-171B
96 CI	FXSTC Softail Custom	07-10	HD-1499		RK-3932		KN-171C*	*Black=KN-171B
96 CI	FXSTC Softail Custom	07-10	HD-1499		RK-3932B		KN-171C*	*Black=KN-171B
96 CI	FXSTC Softail Custom	07-10	HD-1499		RK-3932X		KN-171C*	*Black=KN-171B
96 CI	FXSTC Softail Custom	07-10	HD-1499		RK-3932XB		KN-171C*	*Black=KN-171B
96 CI	FXSTC Softail Custom	07-10	HD-1499		RK-3933	HD-0800DK	KN-171C*	*Black=KN-171B
96 CI	FXSTC Softail Custom	07-10	HD-1499		RK-3933B	HD-0800DK	KN-171C*	*Black=KN-171B
96 CI	FXSTC Softail Custom	07-10	HD-1499		RK-3933X		KN-171C*	*Black=KN-171B
96 CI	FXSTC Softail Custom	07-10	HD-1499		RK-3933XB		KN-171C*	*Black=KN-171B
96 CI	FXSTC Softail Custom	07-10	HD-1499		RK-3934	RK-3901PK	KN-171C*	*Black=KN-171B
96 CI	FXSTC Softail Custom	07-10	HD-1499		RK-3935	RK-3902PK	KN-171C*	*Black=KN-171B

2) Requires Two; 3) Requires Three; 4) Requires Four. The use of custom air filter requires removal of air box. Some custom filters and intakes are not legal for sale or use on any pollution controlled motor vehicle in California or states adopting California emission procedures. See knfilters.com for CARB status on each part for a specific vehicle.



Motorcycle - Application Listing

CC	Model	Year	Air Filter	Air Filter Precharger	Custom	Custom Precharger	Oil Filter	Comments
HARLEY DAVIDSON								
96 CI	FXSTC Softail Custom	07-10	HD-1499		RK-3950*		KN-171C**	*Exc. Lower Fairings/ **Black=KN-171B
96 CI	FXSTC Softail Custom	07-10	HD-1499		RK-3950S*		KN-171C**	*Exc. Lower Fairings/ **Black=KN-171B
96 CI	FXSTD Softail Deuce	07	HD-1499		63-1125*	RC-3680DK	KN-171C**	*Exc. Lower Fairings/ **Black=KN-171B
96 CI	FXSTD Softail Deuce	07	HD-1499		63-1125P*	RC-3680DK	KN-171C**	*Exc. Lower Fairings/ **Black=KN-171B
96 CI	FXSTD Softail Deuce	07	HD-1499		63-1137*		KN-171C**	*Exc. Lower Fairings/ **Black=KN-171B
96 CI	FXSTD Softail Deuce	07	HD-1499		63-1137S*		KN-171C**	*Exc. Lower Fairings/ **Black=KN-171B
96 CI	FXSTD Softail Deuce	07	HD-1499		RK-3909-1*		KN-171C**	*w/1-5/8 inch Tall Filter/ **Black=KN-171B
96 CI	FXSTD Softail Deuce	07	HD-1499		RK-3910-1*		KN-171C**	*w/2-1/4 inch Tall Filter/ **Black=KN-171B
96 CI	FXSTD Softail Deuce	07	HD-1499		RK-3932		KN-171C*	*Black=KN-171B
96 CI	FXSTD Softail Deuce	07	HD-1499		RK-3932B		KN-171C*	*Black=KN-171B
96 CI	FXSTD Softail Deuce	07	HD-1499		RK-3932X		KN-171C*	*Black=KN-171B
96 CI	FXSTD Softail Deuce	07	HD-1499		RK-3932XB		KN-171C*	*Black=KN-171B
96 CI	FXSTD Softail Deuce	07	HD-1499		RK-3933	HD-0800DK	KN-171C*	*Black=KN-171B
96 CI	FXSTD Softail Deuce	07	HD-1499		RK-3933B	HD-0800DK	KN-171C*	*Black=KN-171B
96 CI	FXSTD Softail Deuce	07	HD-1499		RK-3933X		KN-171C*	*Black=KN-171B
96 CI	FXSTD Softail Deuce	07	HD-1499		RK-3933XB		KN-171C*	*Black=KN-171B
96 CI	FXSTD Softail Deuce	07	HD-1499		RK-3934	RK-3901PK	KN-171C*	*Black=KN-171B
96 CI	FXSTD Softail Deuce	07	HD-1499		RK-3935	RK-3902PK	KN-171C*	*Black=KN-171B
96 CI	FXSTD Softail Deuce	07	HD-1499		RK-3950*		KN-171C**	*Exc. Lower Fairings/ **Black=KN-171B
96 CI	FXSTD Softail Deuce	07	HD-1499		RK-3950S*		KN-171C**	*Exc. Lower Fairings/ **Black=KN-171B
103 CI	FLD Switchback	12-15	HD-9608		RK-3931		KN-171C*	*Black=KN-171B
103 CI	FLD Switchback	12-15	HD-9608		RK-3932		KN-171C*	*Black=KN-171B
103 CI	FLD Switchback	12-15	HD-9608		RK-3932B		KN-171C*	*Black=KN-171B
103 CI	FLD Switchback	12-15	HD-9608		RK-3932X		KN-171C*	*Black=KN-171B
103 CI	FLD Switchback	12-15	HD-9608		RK-3932XB		KN-171C*	*Black=KN-171B
103 CI	FLD Switchback	12-15	HD-9608		RK-3933	HD-0800DK	KN-171C*	*Black=KN-171B
103 CI	FLD Switchback	12-15	HD-9608		RK-3933B	HD-0800DK	KN-171C*	*Black=KN-171B
103 CI	FLD Switchback	12-15	HD-9608		RK-3933X		KN-171C*	*Black=KN-171B
103 CI	FLD Switchback	12-15	HD-9608		RK-3933XB		KN-171C*	*Black=KN-171B
103 CI	FLD Switchback	12-15	HD-9608		RK-3934	RK-3901PK	KN-171C*	*Black=KN-171B
103 CI	FLD Switchback	12-15	HD-9608		RK-3935	RK-3902PK	KN-171C*	*Black=KN-171B
103 CI	FLD Switchback	13-15	HD-9608		63-1125*	RC-3680DK	KN-171C**	*Exc. Lower Fairings/ **Black=KN-171B
103 CI	FLD Switchback	13-15	HD-9608		63-1125P*	RC-3680DK	KN-171C**	*Exc. Lower Fairings/ **Black=KN-171B
103 CI	FLD Switchback	13-15	HD-9608		63-1137*		KN-171C**	*Exc. Lower Fairings/ **Black=KN-171B
103 CI	FLD Switchback	13-15	HD-9608		63-1137S*		KN-171C**	*Exc. Lower Fairings/ **Black=KN-171B
103 CI	FLD Switchback	13-15	HD-9608		RK-3950*		KN-171C**	*Exc. Lower Fairings/ **Black=KN-171B
103 CI	FLD Switchback	13-15	HD-9608		RK-3950S*		KN-171C**	*Exc. Lower Fairings/ **Black=KN-171B
103 CI	FLD Switchback	16	HD-0910		63-1125*	RC-3680DK	KN-171C**	*Exc. Lower Fairings/ **Black=KN-171B
103 CI	FLD Switchback	16	HD-0910		63-1125P*	RC-3680DK	KN-171C**	*Exc. Lower Fairings/ **Black=KN-171B
103 CI	FLD Switchback	16	HD-0910		63-1137*		KN-171C**	*Exc. Lower Fairings/ **Black=KN-171B
103 CI	FLD Switchback	16	HD-0910		63-1137S*		KN-171C**	*Exc. Lower Fairings/ **Black=KN-171B

2) Requires Two; 3) Requires Three; 4) Requires Four. The use of custom air filter requires removal of air box. Some custom filters and intakes are not legal for sale or use on any pollution controlled motor vehicle in California or states adopting California emission procedures. See knfilters.com for CARB status on each part for a specific vehicle.

Motorcycle - Application Listing



CC	Model	Year	Air Filter	Air Filter Precharger	Custom	Custom Precharger	Oil Filter	Comments
HARLEY DAVIDSON								
103 CI	FLD Switchback	16	HD-0910		RK-3931		KN-171C*	*Black=KN-171B
103 CI	FLD Switchback	16	HD-0910		RK-3932		KN-171C*	*Black=KN-171B
103 CI	FLD Switchback	16	HD-0910		RK-3932B		KN-171C*	*Black=KN-171B
103 CI	FLD Switchback	16	HD-0910		RK-3932X		KN-171C*	*Black=KN-171B
103 CI	FLD Switchback	16	HD-0910		RK-3932XB		KN-171C*	*Black=KN-171B
103 CI	FLD Switchback	16	HD-0910		RK-3933	HD-0800DK	KN-171C*	*Black=KN-171B
103 CI	FLD Switchback	16	HD-0910		RK-3933B	HD-0800DK	KN-171C*	*Black=KN-171B
103 CI	FLD Switchback	16	HD-0910		RK-3933X		KN-171C*	*Black=KN-171B
103 CI	FLD Switchback	16	HD-0910		RK-3933XB		KN-171C*	*Black=KN-171B
103 CI	FLD Switchback	16	HD-0910		RK-3934	RK-3901PK	KN-171C*	*Black=KN-171B
103 CI	FLD Switchback	16	HD-0910		RK-3935	RK-3902PK	KN-171C*	*Black=KN-171B
103 CI	FLD Switchback	16	HD-0910		RK-3950*		KN-171C**	*Exc. Lower Fairings/ **Black=KN-171B
103 CI	FLD Switchback	16	HD-0910		RK-3950S*		KN-171C**	*Exc. Lower Fairings/ **Black=KN-171B
103 CI	FLD Switchback - Non-US	16	HD-9608				KN-171C*	*Black=KN-171B
103 CI	FLHP Road King Police	09	HD-1508		63-1122*	RC-3680DK	KN-171C**	*Exc. Lower Fairings/ **Black=KN-171B
103 CI	FLHP Road King Police	09	HD-1508		63-1122P*	RC-3680DK	KN-171C**	*Exc. Lower Fairings/ **Black=KN-171B
103 CI	FLHP Road King Police	09	HD-1508		63-1131*		KN-171C**	*w/Lower Fairings/ **Black=KN-171B
103 CI	FLHP Road King Police	09	HD-1508		63-1131P*		KN-171C**	*w/Lower Fairings/ **Black=KN-171B
103 CI	FLHP Road King Police	09	HD-1508		63-1134*		KN-171C**	*Exc. Lower Fairings/ **Black=KN-171B
103 CI	FLHP Road King Police	09	HD-1508		63-1134S*		KN-171C**	*Exc. Lower Fairings/ **Black=KN-171B
103 CI	FLHP Road King Police	09	HD-1508		RK-3930		KN-171C*	*Black=KN-171B
103 CI	FLHP Road King Police	09	HD-1508		RK-3930X		KN-171C*	*Black=KN-171B
103 CI	FLHP Road King Police	09	HD-1508		RK-3936	RK-3901PK	KN-171C*	*Black=KN-171B
103 CI	FLHP Road King Police	09	HD-1508		RK-3937	RK-3902PK	KN-171C*	*Black=KN-171B
103 CI	FLHP Road King Police	09	HD-1508		RK-3938	RK-3901PK	KN-171C*	*Black=KN-171B
103 CI	FLHP Road King Police	09	HD-1508		RK-3939	RK-3902PK	KN-171C*	*Black=KN-171B
103 CI	FLHP Road King Police	09	HD-1508		RK-3946	HD-0800DK	KN-171C*	*Black=KN-171B
103 CI	FLHP Road King Police	09	HD-1508		RK-3946B	HD-0800DK	KN-171C*	*Black=KN-171B
103 CI	FLHP Road King Police	09	HD-1508		RK-3946X		KN-171C*	*Black=KN-171B
103 CI	FLHP Road King Police	09	HD-1508		RK-3946XB		KN-171C*	*Black=KN-171B
103 CI	FLHP Road King Police	09	HD-1508		RK-3947		KN-171C*	*Black=KN-171B
103 CI	FLHP Road King Police	09	HD-1508		RK-3947B		KN-171C*	*Black=KN-171B
103 CI	FLHP Road King Police	09	HD-1508		RK-3947X		KN-171C*	*Black=KN-171B
103 CI	FLHP Road King Police	09	HD-1508		RK-3947XB		KN-171C*	*Black=KN-171B
103 CI	FLHP Road King Police	09	HD-1508		RK-3951*		KN-171C**	*Exc. Lower Fairings/ **Black=KN-171B
103 CI	FLHP Road King Police	09	HD-1508		RK-3951S*		KN-171C**	*Exc. Lower Fairings/ **Black=KN-171B
103 CI	FLHP Road King Police	10-11	HD-1508		63-1131*			*w/Lower Fairings
103 CI	FLHP Road King Police	10-11	HD-1508		63-1131P*			*w/Lower Fairings
103 CI	FLHP Road King Police	10-11	HD-1508		RK-3946	HD-0800DK		
103 CI	FLHP Road King Police	10-11	HD-1508		RK-3946B	HD-0800DK		
103 CI	FLHP Road King Police	10-11	HD-1508		RK-3946X			
103 CI	FLHP Road King Police	10-11	HD-1508		RK-3946XB			
103 CI	FLHP Road King Police	10-11	HD-1508		RK-3947			
103 CI	FLHP Road King Police	10-11	HD-1508		RK-3947B			
103 CI	FLHP Road King Police	10-11	HD-1508		RK-3947X			
103 CI	FLHP Road King Police	10-11	HD-1508		RK-3947XB			
103 CI	FLHP Road King Police	10-12	HD-1508		63-1122*	RC-3680DK		*Exc. Lower Fairings
103 CI	FLHP Road King Police	10-12	HD-1508		63-1122P*	RC-3680DK		*Exc. Lower Fairings

2) Requires Two; 3) Requires Three; 4) Requires Four. The use of custom air filter requires removal of air box. Some custom filters and intakes are not legal for sale or use on any pollution controlled motor vehicle in California or states adopting California emission procedures. See knfilters.com for CARB status on each part for a specific vehicle.



Motorcycle - Application Listing

CC	Model	Year	Air Filter	Air Filter Precharger	Custom	Custom Precharger	Oil Filter	Comments
HARLEY DAVIDSON								
103 CI	FLHP Road King Police	10-12	HD-1508		63-1134*			*Exc. Lower Fairings
103 CI	FLHP Road King Police	10-12	HD-1508		63-1134S*			*Exc. Lower Fairings
103 CI	FLHP Road King Police	10-12	HD-1508		RK-3930			
103 CI	FLHP Road King Police	10-12	HD-1508		RK-3930X			
103 CI	FLHP Road King Police	10-12	HD-1508		RK-3936	RK-3901PK		
103 CI	FLHP Road King Police	10-12	HD-1508		RK-3937	RK-3902PK		
103 CI	FLHP Road King Police	10-12	HD-1508		RK-3938	RK-3901PK		
103 CI	FLHP Road King Police	10-12	HD-1508		RK-3939	RK-3902PK		
103 CI	FLHP Road King Police	10-12	HD-1508		RK-3951*			*Exc. Lower Fairings
103 CI	FLHP Road King Police	10-12	HD-1508		RK-3951S*			*Exc. Lower Fairings
103 CI	FLHR Road King	12-13	HD-1508		63-1122*	RC-3680DK	KN-171C**	*Exc. Lower Fairings/ **Black=KN-171B
103 CI	FLHR Road King	12-13	HD-1508		63-1122P*	RC-3680DK	KN-171C**	*Exc. Lower Fairings/ **Black=KN-171B
103 CI	FLHR Road King	12-13	HD-1508		63-1131*		KN-171C**	*w/Lower Fairings/ **Black=KN-171B
103 CI	FLHR Road King	12-13	HD-1508		63-1131P*		KN-171C**	*w/Lower Fairings/ **Black=KN-171B
103 CI	FLHR Road King	12-13	HD-1508		63-1134*		KN-171C**	*Exc. Lower Fairings/ **Black=KN-171B
103 CI	FLHR Road King	12-13	HD-1508		63-1134S*		KN-171C**	*Exc. Lower Fairings/ **Black=KN-171B
103 CI	FLHR Road King	12-13	HD-1508		RK-3930		KN-171C*	*Black=KN-171B
103 CI	FLHR Road King	12-13	HD-1508		RK-3930X		KN-171C*	*Black=KN-171B
103 CI	FLHR Road King	12-13	HD-1508		RK-3936	RK-3901PK	KN-171C*	*Black=KN-171B
103 CI	FLHR Road King	12-13	HD-1508		RK-3937	RK-3902PK	KN-171C*	*Black=KN-171B
103 CI	FLHR Road King	12-13	HD-1508		RK-3938	RK-3901PK	KN-171C*	*Black=KN-171B
103 CI	FLHR Road King	12-13	HD-1508		RK-3939	RK-3902PK	KN-171C*	*Black=KN-171B
103 CI	FLHR Road King	12-13	HD-1508		RK-3946	HD-0800DK	KN-171C*	*Black=KN-171B
103 CI	FLHR Road King	12-13	HD-1508		RK-3946B	HD-0800DK	KN-171C*	*Black=KN-171B
103 CI	FLHR Road King	12-13	HD-1508		RK-3946X		KN-171C*	*Black=KN-171B
103 CI	FLHR Road King	12-13	HD-1508		RK-3946XB		KN-171C*	*Black=KN-171B
103 CI	FLHR Road King	12-13	HD-1508		RK-3947		KN-171C*	*Black=KN-171B
103 CI	FLHR Road King	12-13	HD-1508		RK-3947B		KN-171C*	*Black=KN-171B
103 CI	FLHR Road King	12-13	HD-1508		RK-3947X		KN-171C*	*Black=KN-171B
103 CI	FLHR Road King	12-13	HD-1508		RK-3947XB		KN-171C*	*Black=KN-171B
103 CI	FLHR Road King	12-13	HD-1508		RK-3951*		KN-171C**	*Exc. Lower Fairings/ **Black=KN-171B
103 CI	FLHR Road King	12-13	HD-1508		RK-3951S*		KN-171C**	*Exc. Lower Fairings/ **Black=KN-171B
103 CI	FLHR Road King	14-15	HD-1614		63-1131*		KN-171C**	*w/Lower Fairings/ **Black=KN-171B
103 CI	FLHR Road King	14-15	HD-1614		63-1131P*		KN-171C**	*w/Lower Fairings/ **Black=KN-171B
103 CI	FLHR Road King	14-15	HD-1614		RK-3946	HD-0800DK	KN-171C*	*Black=KN-171B
103 CI	FLHR Road King	14-15	HD-1614		RK-3946B	HD-0800DK	KN-171C*	*Black=KN-171B
103 CI	FLHR Road King	14-15	HD-1614		RK-3946X		KN-171C*	*Black=KN-171B
103 CI	FLHR Road King	14-15	HD-1614		RK-3946XB		KN-171C*	*Black=KN-171B
103 CI	FLHR Road King	14-15	HD-1614		RK-3947		KN-171C*	*Black=KN-171B
103 CI	FLHR Road King	14-15	HD-1614		RK-3947B		KN-171C*	*Black=KN-171B
103 CI	FLHR Road King	14-15	HD-1614		RK-3947X		KN-171C*	*Black=KN-171B
103 CI	FLHR Road King	14-15	HD-1614		RK-3947XB		KN-171C*	*Black=KN-171B
103 CI	FLHR Road King	14-16	HD-1614		63-1122*	RC-3680DK	KN-171C**	*Exc. Lower Fairings/ **Black=KN-171B
103 CI	FLHR Road King	14-16	HD-1614		63-1122P*	RC-3680DK	KN-171C**	*Exc. Lower Fairings/ **Black=KN-171B
103 CI	FLHR Road King	14-16	HD-1614		63-1134*		KN-171C**	*Exc. Lower Fairings/ **Black=KN-171B

2) Requires Two; 3) Requires Three; 4) Requires Four. The use of custom air filter requires removal of air box. Some custom filters and intakes are not legal for sale or use on any pollution controlled motor vehicle in California or states adopting California emission procedures. See knfilters.com for CARB status on each part for a specific vehicle.

Motorcycle - Application Listing



CC	Model	Year	Air Filter	Air Filter Precharger	Custom	Custom Precharger	Oil Filter	Comments
HARLEY DAVIDSON								
103 CI	FLHR Road King	14-16	HD-1614		63-1134S*		KN-171C**	*Exc. Lower Fairings/ **Black=KN-171B
103 CI	FLHR Road King	14-16	HD-1614		RK-3936	RK-3901PK	KN-171C*	*Black=KN-171B
103 CI	FLHR Road King	14-16	HD-1614		RK-3937	RK-3902PK	KN-171C*	*Black=KN-171B
103 CI	FLHR Road King	14-16	HD-1614		RK-3938	RK-3901PK	KN-171C*	*Black=KN-171B
103 CI	FLHR Road King	14-16	HD-1614		RK-3939	RK-3902PK	KN-171C*	*Black=KN-171B
103 CI	FLHR Road King	14-16	HD-1614		RK-3941		KN-171C*	*Black=KN-171B
103 CI	FLHR Road King	14-16	HD-1614		RK-3951*		KN-171C**	*Exc. Lower Fairings/ **Black=KN-171B
103 CI	FLHR Road King	14-16	HD-1614		RK-3951S*		KN-171C**	*Exc. Lower Fairings/ **Black=KN-171B
103 CI	FLHRC Road King Classic	11	HD-1508		63-1131*		KN-171C**	*w/Lower Fairings/ **Black=KN-171B
103 CI	FLHRC Road King Classic	11	HD-1508		63-1131P*		KN-171C**	*w/Lower Fairings/ **Black=KN-171B
103 CI	FLHRC Road King Classic	11-13	HD-1508		63-1122*	RC-3680DK	KN-171C**	*Exc. Lower Fairings/ **Black=KN-171B
103 CI	FLHRC Road King Classic	11-13	HD-1508		63-1122P*	RC-3680DK	KN-171C**	*Exc. Lower Fairings/ **Black=KN-171B
103 CI	FLHRC Road King Classic	11-13	HD-1508		63-1134*		KN-171C**	*Exc. Lower Fairings/ **Black=KN-171B
103 CI	FLHRC Road King Classic	11-13	HD-1508		63-1134S*		KN-171C**	*Exc. Lower Fairings/ **Black=KN-171B
103 CI	FLHRC Road King Classic	11-13	HD-1508		RK-3930		KN-171C*	*Black=KN-171B
103 CI	FLHRC Road King Classic	11-13	HD-1508		RK-3930X		KN-171C*	*Black=KN-171B
103 CI	FLHRC Road King Classic	11-13	HD-1508		RK-3936	RK-3901PK	KN-171C*	*Black=KN-171B
103 CI	FLHRC Road King Classic	11-13	HD-1508		RK-3937	RK-3902PK	KN-171C*	*Black=KN-171B
103 CI	FLHRC Road King Classic	11-13	HD-1508		RK-3938	RK-3901PK	KN-171C*	*Black=KN-171B
103 CI	FLHRC Road King Classic	11-13	HD-1508		RK-3939	RK-3902PK	KN-171C*	*Black=KN-171B
103 CI	FLHRC Road King Classic	11-13	HD-1508		RK-3946	HD-0800DK	KN-171C*	*Black=KN-171B
103 CI	FLHRC Road King Classic	11-13	HD-1508		RK-3946B	HD-0800DK	KN-171C*	*Black=KN-171B
103 CI	FLHRC Road King Classic	11-13	HD-1508		RK-3946X		KN-171C*	*Black=KN-171B
103 CI	FLHRC Road King Classic	11-13	HD-1508		RK-3946XB		KN-171C*	*Black=KN-171B
103 CI	FLHRC Road King Classic	11-13	HD-1508		RK-3947		KN-171C*	*Black=KN-171B
103 CI	FLHRC Road King Classic	11-13	HD-1508		RK-3947B		KN-171C*	*Black=KN-171B
103 CI	FLHRC Road King Classic	11-13	HD-1508		RK-3947X		KN-171C*	*Black=KN-171B
103 CI	FLHRC Road King Classic	11-13	HD-1508		RK-3947XB		KN-171C*	*Black=KN-171B
103 CI	FLHRC Road King Classic	11-13	HD-1508		RK-3951*		KN-171C**	*Exc. Lower Fairings/ **Black=KN-171B
103 CI	FLHRC Road King Classic	11-13	HD-1508		RK-3951S*		KN-171C**	*Exc. Lower Fairings/ **Black=KN-171B
103 CI	FLHRC Road King Classic	13	HD-1508		63-1131*		KN-171C**	*w/Lower Fairings/ **Black=KN-171B
103 CI	FLHRC Road King Classic	13	HD-1508		63-1131P*		KN-171C**	*w/Lower Fairings/ **Black=KN-171B
103 CI	FLHTC Electra Glide Classic	12-13	HD-1508		63-1122*	RC-3680DK	KN-171C**	*Exc. Lower Fairings/ **Black=KN-171B
103 CI	FLHTC Electra Glide Classic	12-13	HD-1508		63-1122P*	RC-3680DK	KN-171C**	*Exc. Lower Fairings/ **Black=KN-171B
103 CI	FLHTC Electra Glide Classic	12-13	HD-1508		63-1131*		KN-171C**	*w/Lower Fairings/ **Black=KN-171B
103 CI	FLHTC Electra Glide Classic	12-13	HD-1508		63-1131P*		KN-171C**	*w/Lower Fairings/ **Black=KN-171B
103 CI	FLHTC Electra Glide Classic	12-13	HD-1508		63-1134*		KN-171C**	*Exc. Lower Fairings/ **Black=KN-171B
103 CI	FLHTC Electra Glide Classic	12-13	HD-1508		63-1134S*		KN-171C**	*Exc. Lower Fairings/ **Black=KN-171B
103 CI	FLHTC Electra Glide Classic	12-13	HD-1508		RK-3930		KN-171C*	*Black=KN-171B
103 CI	FLHTC Electra Glide Classic	12-13	HD-1508		RK-3930X		KN-171C*	*Black=KN-171B
103 CI	FLHTC Electra Glide Classic	12-13	HD-1508		RK-3936	RK-3901PK	KN-171C*	*Black=KN-171B
103 CI	FLHTC Electra Glide Classic	12-13	HD-1508		RK-3937	RK-3902PK	KN-171C*	*Black=KN-171B

2) Requires Two; 3) Requires Three; 4) Requires Four. The use of custom air filter requires removal of air box. Some custom filters and intakes are not legal for sale or use on any pollution controlled motor vehicle in California or states adopting California emission procedures. See knfilters.com for CARB status on each part for a specific vehicle.



Motorcycle - Application Listing

CC	Model	Year	Air Filter	Air Filter Precharger	Custom	Custom Precharger	Oil Filter	Comments
HARLEY DAVIDSON								
103 CI	FLHTC Electra Glide Classic	12-13	HD-1508		RK-3938	RK-3901PK	KN-171C*	*Black=KN-171B
103 CI	FLHTC Electra Glide Classic	12-13	HD-1508		RK-3939	RK-3902PK	KN-171C*	*Black=KN-171B
103 CI	FLHTC Electra Glide Classic	12-13	HD-1508		RK-3946	HD-0800DK	KN-171C*	*Black=KN-171B
103 CI	FLHTC Electra Glide Classic	12-13	HD-1508		RK-3946B	HD-0800DK	KN-171C*	*Black=KN-171B
103 CI	FLHTC Electra Glide Classic	12-13	HD-1508		RK-3946X		KN-171C*	*Black=KN-171B
103 CI	FLHTC Electra Glide Classic	12-13	HD-1508		RK-3946XB		KN-171C*	*Black=KN-171B
103 CI	FLHTC Electra Glide Classic	12-13	HD-1508		RK-3947		KN-171C*	*Black=KN-171B
103 CI	FLHTC Electra Glide Classic	12-13	HD-1508		RK-3947B		KN-171C*	*Black=KN-171B
103 CI	FLHTC Electra Glide Classic	12-13	HD-1508		RK-3947X		KN-171C*	*Black=KN-171B
103 CI	FLHTC Electra Glide Classic	12-13	HD-1508		RK-3947XB		KN-171C*	*Black=KN-171B
103 CI	FLHTC Electra Glide Classic	12-13	HD-1508		RK-3951*		KN-171C**	*Exc. Lower Fairings/ **Black=KN-171B
103 CI	FLHTC Electra Glide Classic	12-13	HD-1508		RK-3951S*		KN-171C**	*Exc. Lower Fairings/ **Black=KN-171B
103 CI	FLHTCSE Screamin Eagle Electra Glide	03-04					KN-171C*	*Black=KN-171B
103 CI	FLHTCSE2 Screamin Eagle Electra Glide 2	05	HD-0800*	HD-0800DK			KN-171C**	*OEM 2944299A/B/C/D/ **Black=KN-171B
103 CI	FLHTCSE2 Screamin Eagle Electra Glide 2	05	HD-1499*				KN-171C**	*OEM 2946199/ **Black=KN-171B
103 CI	FLHTCU Electra Glide Ultra Classic	12	HD-1508		63-1131*		KN-171C**	*w/Lower Fairings/ **Black=KN-171B
103 CI	FLHTCU Electra Glide Ultra Classic	12	HD-1508		63-1131P*		KN-171C**	*w/Lower Fairings/ **Black=KN-171B
103 CI	FLHTCU Electra Glide Ultra Classic	12	HD-1508		RK-3930		KN-171C*	*Black=KN-171B
103 CI	FLHTCU Electra Glide Ultra Classic	12	HD-1508		RK-3930X		KN-171C*	*Black=KN-171B
103 CI	FLHTCU Electra Glide Ultra Classic	12	HD-1508		RK-3936	RK-3901PK	KN-171C*	*Black=KN-171B
103 CI	FLHTCU Electra Glide Ultra Classic	12	HD-1508		RK-3937	RK-3902PK	KN-171C*	*Black=KN-171B
103 CI	FLHTCU Electra Glide Ultra Classic	12	HD-1508		RK-3938	RK-3901PK	KN-171C*	*Black=KN-171B
103 CI	FLHTCU Electra Glide Ultra Classic	12	HD-1508		RK-3939	RK-3902PK	KN-171C*	*Black=KN-171B
103 CI	FLHTCU Electra Glide Ultra Classic	12	HD-1508		RK-3946	HD-0800DK	KN-171C*	*Black=KN-171B
103 CI	FLHTCU Electra Glide Ultra Classic	12	HD-1508		RK-3946B	HD-0800DK	KN-171C*	*Black=KN-171B
103 CI	FLHTCU Electra Glide Ultra Classic	12	HD-1508		RK-3946X		KN-171C*	*Black=KN-171B
103 CI	FLHTCU Electra Glide Ultra Classic	12	HD-1508		RK-3946XB		KN-171C*	*Black=KN-171B
103 CI	FLHTCU Electra Glide Ultra Classic	12	HD-1508		RK-3947		KN-171C*	*Black=KN-171B
103 CI	FLHTCU Electra Glide Ultra Classic	12	HD-1508		RK-3947B		KN-171C*	*Black=KN-171B
103 CI	FLHTCU Electra Glide Ultra Classic	12	HD-1508		RK-3947X		KN-171C*	*Black=KN-171B
103 CI	FLHTCU Electra Glide Ultra Classic	12	HD-1508		RK-3947XB		KN-171C*	*Black=KN-171B
103 CI	FLHTCU Electra Glide Ultra Classic	14-15	HD-1614		63-1131*		KN-171C**	*w/Lower Fairings/ **Black=KN-171B
103 CI	FLHTCU Electra Glide Ultra Classic	14-15	HD-1614		63-1131P*		KN-171C**	*w/Lower Fairings/ **Black=KN-171B
103 CI	FLHTCU Electra Glide Ultra Classic	14-15	HD-1614		RK-3946	HD-0800DK	KN-171C*	*Black=KN-171B
103 CI	FLHTCU Electra Glide Ultra Classic	14-15	HD-1614		RK-3946B	HD-0800DK	KN-171C*	*Black=KN-171B
103 CI	FLHTCU Electra Glide Ultra Classic	14-15	HD-1614		RK-3946X		KN-171C*	*Black=KN-171B
103 CI	FLHTCU Electra Glide Ultra Classic	14-15	HD-1614		RK-3946XB		KN-171C*	*Black=KN-171B
103 CI	FLHTCU Electra Glide Ultra Classic	14-15	HD-1614		RK-3947		KN-171C*	*Black=KN-171B
103 CI	FLHTCU Electra Glide Ultra Classic	14-15	HD-1614		RK-3947B		KN-171C*	*Black=KN-171B
103 CI	FLHTCU Electra Glide Ultra Classic	14-15	HD-1614		RK-3947X		KN-171C*	*Black=KN-171B
103 CI	FLHTCU Electra Glide Ultra Classic	14-15	HD-1614		RK-3947XB		KN-171C*	*Black=KN-171B
103 CI	FLHTCU Electra Glide Ultra Classic	14-16	HD-1614		RK-3936	RK-3901PK	KN-171C*	*Black=KN-171B
103 CI	FLHTCU Electra Glide Ultra Classic	14-16	HD-1614		RK-3937	RK-3902PK	KN-171C*	*Black=KN-171B
103 CI	FLHTCU Electra Glide Ultra Classic	14-16	HD-1614		RK-3938	RK-3901PK	KN-171C*	*Black=KN-171B
103 CI	FLHTCU Electra Glide Ultra Classic	14-16	HD-1614		RK-3939	RK-3902PK	KN-171C*	*Black=KN-171B
103 CI	FLHTCU Electra Glide Ultra Classic	14-16	HD-1614		RK-3941		KN-171C*	*Black=KN-171B
103 CI	FLHTCU Ultra Classic Electra Glide	13	HD-1508		63-1131*		KN-171C**	*w/Lower Fairings/ **Black=KN-171B
103 CI	FLHTCU Ultra Classic Electra Glide	13	HD-1508		63-1131P*		KN-171C**	*w/Lower Fairings/ **Black=KN-171B

2) Requires Two; 3) Requires Three; 4) Requires Four. The use of custom air filter requires removal of air box. Some custom filters and intakes are not legal for sale or use on any pollution controlled motor vehicle in California or states adopting California emission procedures. See knfilters.com for CARB status on each part for a specific vehicle.

Motorcycle - Application Listing



CC	Model	Year	Air Filter	Air Filter Precharger	Custom	Custom Precharger	Oil Filter	Comments
HARLEY DAVIDSON								
103 CI	FLHTCU Ultra Classic Electra Glide	13	HD-1508		RK-3930		KN-171C*	*Black=KN-171B
103 CI	FLHTCU Ultra Classic Electra Glide	13	HD-1508		RK-3930X		KN-171C*	*Black=KN-171B
103 CI	FLHTCU Ultra Classic Electra Glide	13	HD-1508		RK-3936	RK-3901PK	KN-171C*	*Black=KN-171B
103 CI	FLHTCU Ultra Classic Electra Glide	13	HD-1508		RK-3937	RK-3902PK	KN-171C*	*Black=KN-171B
103 CI	FLHTCU Ultra Classic Electra Glide	13	HD-1508		RK-3938	RK-3901PK	KN-171C*	*Black=KN-171B
103 CI	FLHTCU Ultra Classic Electra Glide	13	HD-1508		RK-3939	RK-3902PK	KN-171C*	*Black=KN-171B
103 CI	FLHTCU Ultra Classic Electra Glide	13	HD-1508		RK-3946	HD-0800DK	KN-171C*	*Black=KN-171B
103 CI	FLHTCU Ultra Classic Electra Glide	13	HD-1508		RK-3946B	HD-0800DK	KN-171C*	*Black=KN-171B
103 CI	FLHTCU Ultra Classic Electra Glide	13	HD-1508		RK-3946X		KN-171C*	*Black=KN-171B
103 CI	FLHTCU Ultra Classic Electra Glide	13	HD-1508		RK-3946XB		KN-171C*	*Black=KN-171B
103 CI	FLHTCU Ultra Classic Electra Glide	13	HD-1508		RK-3947		KN-171C*	*Black=KN-171B
103 CI	FLHTCU Ultra Classic Electra Glide	13	HD-1508		RK-3947B		KN-171C*	*Black=KN-171B
103 CI	FLHTCU Ultra Classic Electra Glide	13	HD-1508		RK-3947X		KN-171C*	*Black=KN-171B
103 CI	FLHTCU Ultra Classic Electra Glide	13	HD-1508		RK-3947XB		KN-171C*	*Black=KN-171B
103 CI	FLHTCUL Electra Glide Ultra Classic Low	15	HD-1614		63-1131*		KN-171C**	*w/Lower Fairings/ **Black=KN-171B
103 CI	FLHTCUL Electra Glide Ultra Classic Low	15	HD-1614		63-1131P*		KN-171C**	*w/Lower Fairings/ **Black=KN-171B
103 CI	FLHTCUL Electra Glide Ultra Classic Low	15	HD-1614		RK-3941		KN-171C*	*Black=KN-171B
103 CI	FLHTCUL Electra Glide Ultra Classic Low	15	HD-1614		RK-3946	HD-0800DK	KN-171C*	*Black=KN-171B
103 CI	FLHTCUL Electra Glide Ultra Classic Low	15	HD-1614		RK-3946B	HD-0800DK	KN-171C*	*Black=KN-171B
103 CI	FLHTCUL Electra Glide Ultra Classic Low	15	HD-1614		RK-3946X		KN-171C*	*Black=KN-171B
103 CI	FLHTCUL Electra Glide Ultra Classic Low	15	HD-1614		RK-3946XB		KN-171C*	*Black=KN-171B
103 CI	FLHTCUL Electra Glide Ultra Classic Low	15	HD-1614		RK-3947		KN-171C*	*Black=KN-171B
103 CI	FLHTCUL Electra Glide Ultra Classic Low	15	HD-1614		RK-3947B		KN-171C*	*Black=KN-171B
103 CI	FLHTCUL Electra Glide Ultra Classic Low	15	HD-1614		RK-3947X		KN-171C*	*Black=KN-171B
103 CI	FLHTCUL Electra Glide Ultra Classic Low	15	HD-1614		RK-3947XB		KN-171C*	*Black=KN-171B
103 CI	FLHTCUL Electra Glide Ultra Classic Low	15-16	HD-1614		RK-3936	RK-3901PK	KN-171C*	*Black=KN-171B
103 CI	FLHTCUL Electra Glide Ultra Classic Low	15-16	HD-1614		RK-3937	RK-3902PK	KN-171C*	*Black=KN-171B
103 CI	FLHTCUL Electra Glide Ultra Classic Low	15-16	HD-1614		RK-3938	RK-3901PK	KN-171C*	*Black=KN-171B
103 CI	FLHTCUL Electra Glide Ultra Classic Low	15-16	HD-1614		RK-3939	RK-3902PK	KN-171C*	*Black=KN-171B
103 CI	FLHTCUSE Screamin Eagle Ultra Classic Electra Glid	06	HD-1499					
103 CI	FLHTCUTG Tri Glide Ultra	14-15	HD-1614		63-1131*		KN-171C**	*w/Lower Fairings/ **Black=KN-171B
103 CI	FLHTCUTG Tri Glide Ultra	14-15	HD-1614		63-1131P*		KN-171C**	*w/Lower Fairings/ **Black=KN-171B
103 CI	FLHTCUTG Tri Glide Ultra	14-15	HD-1614		RK-3946	HD-0800DK	KN-171C*	*Black=KN-171B
103 CI	FLHTCUTG Tri Glide Ultra	14-15	HD-1614		RK-3946B	HD-0800DK	KN-171C*	*Black=KN-171B
103 CI	FLHTCUTG Tri Glide Ultra	14-15	HD-1614		RK-3946X		KN-171C*	*Black=KN-171B
103 CI	FLHTCUTG Tri Glide Ultra	14-15	HD-1614		RK-3946XB		KN-171C*	*Black=KN-171B
103 CI	FLHTCUTG Tri Glide Ultra	14-15	HD-1614		RK-3947		KN-171C*	*Black=KN-171B
103 CI	FLHTCUTG Tri Glide Ultra	14-15	HD-1614		RK-3947B		KN-171C*	*Black=KN-171B
103 CI	FLHTCUTG Tri Glide Ultra	14-15	HD-1614		RK-3947X		KN-171C*	*Black=KN-171B
103 CI	FLHTCUTG Tri Glide Ultra	14-15	HD-1614		RK-3947XB		KN-171C*	*Black=KN-171B
103 CI	FLHTCUTG Tri Glide Ultra	14-16	HD-1614		RK-3941		KN-171C*	*Black=KN-171B
103 CI	FLHTCUTG Tri Glide Ultra Classic	09-13	HD-1508		63-1131*		KN-171C**	*w/Lower Fairings/ **Black=KN-171B
103 CI	FLHTCUTG Tri Glide Ultra Classic	09-13	HD-1508		63-1131P*		KN-171C**	*w/Lower Fairings/ **Black=KN-171B
103 CI	FLHTCUTG Tri Glide Ultra Classic	09-13	HD-1508		RK-3930		KN-171C*	*Black=KN-171B
103 CI	FLHTCUTG Tri Glide Ultra Classic	09-13	HD-1508		RK-3930X		KN-171C*	*Black=KN-171B
103 CI	FLHTCUTG Tri Glide Ultra Classic	09-13	HD-1508		RK-3936	RK-3901PK	KN-171C*	*Black=KN-171B
103 CI	FLHTCUTG Tri Glide Ultra Classic	09-13	HD-1508		RK-3937	RK-3902PK	KN-171C*	*Black=KN-171B
103 CI	FLHTCUTG Tri Glide Ultra Classic	09-13	HD-1508		RK-3938	RK-3901PK	KN-171C*	*Black=KN-171B
103 CI	FLHTCUTG Tri Glide Ultra Classic	09-13	HD-1508		RK-3939	RK-3902PK	KN-171C*	*Black=KN-171B
103 CI	FLHTCUTG Tri Glide Ultra Classic	09-13	HD-1508		RK-3946	HD-0800DK	KN-171C*	*Black=KN-171B

2) Requires Two; 3) Requires Three; 4) Requires Four. The use of custom air filter requires removal of air box. Some custom filters and intakes are not legal for sale or use on any pollution controlled motor vehicle in California or states adopting California emission procedures. See knfilters.com for CARB status on each part for a specific vehicle.



Motorcycle - Application Listing

CC	Model	Year	Air Filter	Air Filter Precharger	Custom	Custom Precharger	Oil Filter	Comments
HARLEY DAVIDSON								
103 CI	FLHTCUTG Tri Glide Ultra Classic	09-13	HD-1508		RK-3946B	HD-0800DK	KN-171C*	*Black=KN-171B
103 CI	FLHTCUTG Tri Glide Ultra Classic	09-13	HD-1508		RK-3946X		KN-171C*	*Black=KN-171B
103 CI	FLHTCUTG Tri Glide Ultra Classic	09-13	HD-1508		RK-3946XB		KN-171C*	*Black=KN-171B
103 CI	FLHTCUTG Tri Glide Ultra Classic	09-13	HD-1508		RK-3947		KN-171C*	*Black=KN-171B
103 CI	FLHTCUTG Tri Glide Ultra Classic	09-13	HD-1508		RK-3947B		KN-171C*	*Black=KN-171B
103 CI	FLHTCUTG Tri Glide Ultra Classic	09-13	HD-1508		RK-3947X		KN-171C*	*Black=KN-171B
103 CI	FLHTCUTG Tri Glide Ultra Classic	09-13	HD-1508		RK-3947XB		KN-171C*	*Black=KN-171B
103 CI	FLHTK Electra Glide Ultra Limited	10-13	HD-1508		63-1131*		KN-171C**	*w/Lower Fairings/ **Black=KN-171B
103 CI	FLHTK Electra Glide Ultra Limited	10-13	HD-1508		63-1131P*		KN-171C**	*w/Lower Fairings/ **Black=KN-171B
103 CI	FLHTK Electra Glide Ultra Limited	10-13	HD-1508		RK-3930		KN-171C*	*Black=KN-171B
103 CI	FLHTK Electra Glide Ultra Limited	10-13	HD-1508		RK-3930X		KN-171C*	*Black=KN-171B
103 CI	FLHTK Electra Glide Ultra Limited	10-13	HD-1508		RK-3946	HD-0800DK	KN-171C*	*Black=KN-171B
103 CI	FLHTK Electra Glide Ultra Limited	10-13	HD-1508		RK-3946B	HD-0800DK	KN-171C*	*Black=KN-171B
103 CI	FLHTK Electra Glide Ultra Limited	10-13	HD-1508		RK-3946X		KN-171C*	*Black=KN-171B
103 CI	FLHTK Electra Glide Ultra Limited	10-13	HD-1508		RK-3946XB		KN-171C*	*Black=KN-171B
103 CI	FLHTK Electra Glide Ultra Limited	10-13	HD-1508		RK-3947		KN-171C*	*Black=KN-171B
103 CI	FLHTK Electra Glide Ultra Limited	10-13	HD-1508		RK-3947B		KN-171C*	*Black=KN-171B
103 CI	FLHTK Electra Glide Ultra Limited	10-13	HD-1508		RK-3947X		KN-171C*	*Black=KN-171B
103 CI	FLHTK Electra Glide Ultra Limited	10-13	HD-1508		RK-3947XB		KN-171C*	*Black=KN-171B
103 CI	FLHTK Electra Glide Ultra Limited	11-13	HD-1508		RK-3936	RK-3901PK	KN-171C*	*Black=KN-171B
103 CI	FLHTK Electra Glide Ultra Limited	11-13	HD-1508		RK-3937	RK-3902PK	KN-171C*	*Black=KN-171B
103 CI	FLHTK Electra Glide Ultra Limited	11-13	HD-1508		RK-3938	RK-3901PK	KN-171C*	*Black=KN-171B
103 CI	FLHTK Electra Glide Ultra Limited	11-13	HD-1508		RK-3939	RK-3902PK	KN-171C*	*Black=KN-171B
103 CI	FLHTK Electra Glide Ultra Limited	14	HD-1614		63-1131*		KN-171C**	*w/Lower Fairings/ **Black=KN-171B
103 CI	FLHTK Electra Glide Ultra Limited	14	HD-1614		63-1131P*		KN-171C**	*w/Lower Fairings/ **Black=KN-171B
103 CI	FLHTK Electra Glide Ultra Limited	14	HD-1614		RK-3936	RK-3901PK	KN-171C*	*Black=KN-171B
103 CI	FLHTK Electra Glide Ultra Limited	14	HD-1614		RK-3937	RK-3902PK	KN-171C*	*Black=KN-171B
103 CI	FLHTK Electra Glide Ultra Limited	14	HD-1614		RK-3938	RK-3901PK	KN-171C*	*Black=KN-171B
103 CI	FLHTK Electra Glide Ultra Limited	14	HD-1614		RK-3939	RK-3902PK	KN-171C*	*Black=KN-171B
103 CI	FLHTK Electra Glide Ultra Limited	14	HD-1614		RK-3941		KN-171C*	*Black=KN-171B
103 CI	FLHTK Electra Glide Ultra Limited	14	HD-1614		RK-3946	HD-0800DK	KN-171C*	*Black=KN-171B
103 CI	FLHTK Electra Glide Ultra Limited	14	HD-1614		RK-3946B	HD-0800DK	KN-171C*	*Black=KN-171B
103 CI	FLHTK Electra Glide Ultra Limited	14	HD-1614		RK-3946X		KN-171C*	*Black=KN-171B
103 CI	FLHTK Electra Glide Ultra Limited	14	HD-1614		RK-3946XB		KN-171C*	*Black=KN-171B
103 CI	FLHTK Electra Glide Ultra Limited	14	HD-1614		RK-3947		KN-171C*	*Black=KN-171B
103 CI	FLHTK Electra Glide Ultra Limited	14	HD-1614		RK-3947B		KN-171C*	*Black=KN-171B
103 CI	FLHTK Electra Glide Ultra Limited	14	HD-1614		RK-3947X		KN-171C*	*Black=KN-171B
103 CI	FLHTK Electra Glide Ultra Limited	14	HD-1614		RK-3947XB		KN-171C*	*Black=KN-171B
103 CI	FLHTK Ultra Limited	15	HD-1614		63-1131*		KN-171C**	*w/Lower Fairings/ **Black=KN-171B
103 CI	FLHTK Ultra Limited	15	HD-1614		63-1131P*		KN-171C**	*w/Lower Fairings/ **Black=KN-171B
103 CI	FLHTK Ultra Limited	15	HD-1614		RK-3946	HD-0800DK	KN-171C*	*Black=KN-171B
103 CI	FLHTK Ultra Limited	15	HD-1614		RK-3946B	HD-0800DK	KN-171C*	*Black=KN-171B
103 CI	FLHTK Ultra Limited	15	HD-1614		RK-3946X		KN-171C*	*Black=KN-171B
103 CI	FLHTK Ultra Limited	15	HD-1614		RK-3946XB		KN-171C*	*Black=KN-171B
103 CI	FLHTK Ultra Limited	15	HD-1614		RK-3947		KN-171C*	*Black=KN-171B
103 CI	FLHTK Ultra Limited	15	HD-1614		RK-3947B		KN-171C*	*Black=KN-171B
103 CI	FLHTK Ultra Limited	15	HD-1614		RK-3947X		KN-171C*	*Black=KN-171B
103 CI	FLHTK Ultra Limited	15	HD-1614		RK-3947XB		KN-171C*	*Black=KN-171B
103 CI	FLHTK Ultra Limited	15-16	HD-1614		RK-3936	RK-3901PK	KN-171C*	*Black=KN-171B
103 CI	FLHTK Ultra Limited	15-16	HD-1614		RK-3937	RK-3902PK	KN-171C*	*Black=KN-171B
103 CI	FLHTK Ultra Limited	15-16	HD-1614		RK-3938	RK-3901PK	KN-171C*	*Black=KN-171B

2) Requires Two; 3) Requires Three; 4) Requires Four. The use of custom air filter requires removal of air box. Some custom filters and intakes are not legal for sale or use on any pollution controlled motor vehicle in California or states adopting California emission procedures. See knfilters.com for CARB status on each part for a specific vehicle.

Motorcycle - Application Listing



CC	Model	Year	Air Filter	Air Filter Precharger	Custom	Custom Precharger	Oil Filter	Comments
HARLEY DAVIDSON								
103 CI	FLHTK Ultra Limited	15-16	HD-1614		RK-3939	RK-3902PK	KN-171C*	*Black=KN-171B
103 CI	FLHTK Ultra Limited	15-16	HD-1614		RK-3941		KN-171C*	*Black=KN-171B
103 CI	FLHTKL Ultra Limited Low	15	HD-1614		63-1131*		KN-171C**	*w/Lower Fairings/ **Black=KN-171B
103 CI	FLHTKL Ultra Limited Low	15	HD-1614		63-1131P*		KN-171C**	*w/Lower Fairings/ **Black=KN-171B
103 CI	FLHTKL Ultra Limited Low	15	HD-1614		RK-3946	HD-0800DK	KN-171C*	*Black=KN-171B
103 CI	FLHTKL Ultra Limited Low	15	HD-1614		RK-3946B	HD-0800DK	KN-171C*	*Black=KN-171B
103 CI	FLHTKL Ultra Limited Low	15	HD-1614		RK-3946X		KN-171C*	*Black=KN-171B
103 CI	FLHTKL Ultra Limited Low	15	HD-1614		RK-3946XB		KN-171C*	*Black=KN-171B
103 CI	FLHTKL Ultra Limited Low	15	HD-1614		RK-3947		KN-171C*	*Black=KN-171B
103 CI	FLHTKL Ultra Limited Low	15	HD-1614		RK-3947B		KN-171C*	*Black=KN-171B
103 CI	FLHTKL Ultra Limited Low	15	HD-1614		RK-3947X		KN-171C*	*Black=KN-171B
103 CI	FLHTKL Ultra Limited Low	15	HD-1614		RK-3947XB		KN-171C*	*Black=KN-171B
103 CI	FLHTKL Ultra Limited Low	15-16	HD-1614		RK-3936	RK-3901PK	KN-171C*	*Black=KN-171B
103 CI	FLHTKL Ultra Limited Low	15-16	HD-1614		RK-3937	RK-3902PK	KN-171C*	*Black=KN-171B
103 CI	FLHTKL Ultra Limited Low	15-16	HD-1614		RK-3938	RK-3901PK	KN-171C*	*Black=KN-171B
103 CI	FLHTKL Ultra Limited Low	15-16	HD-1614		RK-3939	RK-3902PK	KN-171C*	*Black=KN-171B
103 CI	FLHTKL Ultra Limited Low	15-16	HD-1614		RK-3941		KN-171C*	*Black=KN-171B
103 CI	FLHTP Electra Glide Police	07	HD-1499					
103 CI	FLHTP Electra Glide Police	09	HD-1508		63-1122*	RC-3680DK	KN-171C**	*Exc. Lower Fairings/ **Black=KN-171B
103 CI	FLHTP Electra Glide Police	09	HD-1508		63-1122P*	RC-3680DK	KN-171C**	*Exc. Lower Fairings/ **Black=KN-171B
103 CI	FLHTP Electra Glide Police	09	HD-1508		63-1134*		KN-171C**	*Exc. Lower Fairings/ **Black=KN-171B
103 CI	FLHTP Electra Glide Police	09	HD-1508		63-1134S*		KN-171C**	*Exc. Lower Fairings/ **Black=KN-171B
103 CI	FLHTP Electra Glide Police	09	HD-1508		RK-3930		KN-171C*	*Black=KN-171B
103 CI	FLHTP Electra Glide Police	09	HD-1508		RK-3930X		KN-171C*	*Black=KN-171B
103 CI	FLHTP Electra Glide Police	09	HD-1508		RK-3936	RK-3901PK	KN-171C*	*Black=KN-171B
103 CI	FLHTP Electra Glide Police	09	HD-1508		RK-3937	RK-3902PK	KN-171C*	*Black=KN-171B
103 CI	FLHTP Electra Glide Police	09	HD-1508		RK-3938	RK-3901PK	KN-171C*	*Black=KN-171B
103 CI	FLHTP Electra Glide Police	09	HD-1508		RK-3939	RK-3902PK	KN-171C*	*Black=KN-171B
103 CI	FLHTP Electra Glide Police	09	HD-1508		RK-3946	HD-0800DK	KN-171C*	*Black=KN-171B
103 CI	FLHTP Electra Glide Police	09	HD-1508		RK-3946B	HD-0800DK	KN-171C*	*Black=KN-171B
103 CI	FLHTP Electra Glide Police	09	HD-1508		RK-3946X		KN-171C*	*Black=KN-171B
103 CI	FLHTP Electra Glide Police	09	HD-1508		RK-3946XB		KN-171C*	*Black=KN-171B
103 CI	FLHTP Electra Glide Police	09	HD-1508		RK-3947		KN-171C*	*Black=KN-171B
103 CI	FLHTP Electra Glide Police	09	HD-1508		RK-3947B		KN-171C*	*Black=KN-171B
103 CI	FLHTP Electra Glide Police	09	HD-1508		RK-3947X		KN-171C*	*Black=KN-171B
103 CI	FLHTP Electra Glide Police	09	HD-1508		RK-3947XB		KN-171C*	*Black=KN-171B
103 CI	FLHTP Electra Glide Police	09	HD-1508		RK-3951*		KN-171C**	*Exc. Lower Fairings/ **Black=KN-171B
103 CI	FLHTP Electra Glide Police	09	HD-1508		RK-3951S*		KN-171C**	*Exc. Lower Fairings/ **Black=KN-171B
103 CI	FLHTP Electra Glide Police	10-11	HD-1508		63-1131*			*w/Lower Fairings
103 CI	FLHTP Electra Glide Police	10-11	HD-1508		63-1131P*			*w/Lower Fairings
103 CI	FLHTP Electra Glide Police	10-11	HD-1508		RK-3946	HD-0800DK		
103 CI	FLHTP Electra Glide Police	10-11	HD-1508		RK-3946B	HD-0800DK		
103 CI	FLHTP Electra Glide Police	10-11	HD-1508		RK-3946X			
103 CI	FLHTP Electra Glide Police	10-11	HD-1508		RK-3946XB			
103 CI	FLHTP Electra Glide Police	10-11	HD-1508		RK-3947			
103 CI	FLHTP Electra Glide Police	10-11	HD-1508		RK-3947B			
103 CI	FLHTP Electra Glide Police	10-11	HD-1508		RK-3947X			
103 CI	FLHTP Electra Glide Police	10-11	HD-1508		RK-3947XB			
103 CI	FLHTP Electra Glide Police	10-12	HD-1508		63-1122*	RC-3680DK		*Exc. Lower Fairings
103 CI	FLHTP Electra Glide Police	10-12	HD-1508		63-1122P*	RC-3680DK		*Exc. Lower Fairings

2) Requires Two; 3) Requires Three; 4) Requires Four. The use of custom air filter requires removal of air box. Some custom filters and intakes are not legal for sale or use on any pollution controlled motor vehicle in California or states adopting California emission procedures. See knfilters.com for CARB status on each part for a specific vehicle.



Motorcycle - Application Listing

CC	Model	Year	Air Filter	Air Filter Precharger	Custom	Custom Precharger	Oil Filter	Comments
HARLEY DAVIDSON								
103 CI	FLHTP Electra Glide Police	10-12	HD-1508		63-1134*			*Exc. Lower Fairings
103 CI	FLHTP Electra Glide Police	10-12	HD-1508		63-1134S*			*Exc. Lower Fairings
103 CI	FLHTP Electra Glide Police	10-12	HD-1508		RK-3930			
103 CI	FLHTP Electra Glide Police	10-12	HD-1508		RK-3930X			
103 CI	FLHTP Electra Glide Police	10-12	HD-1508		RK-3936	RK-3901PK		
103 CI	FLHTP Electra Glide Police	10-12	HD-1508		RK-3937	RK-3902PK		
103 CI	FLHTP Electra Glide Police	10-12	HD-1508		RK-3938	RK-3901PK		
103 CI	FLHTP Electra Glide Police	10-12	HD-1508		RK-3939	RK-3902PK		
103 CI	FLHTP Electra Glide Police	10-12	HD-1508		RK-3951*			*Exc. Lower Fairings
103 CI	FLHTP Electra Glide Police	10-12	HD-1508		RK-3951S*			*Exc. Lower Fairings
103 CI	FLHTSEI Screamin Eagle Road King F/I	03					KN-171C*	*Black=KN-171B
103 CI	FLHX Electra Glide Special	16	HD-1614		RK-3936	RK-3901PK		
103 CI	FLHX Electra Glide Special	16	HD-1614		RK-3937	RK-3902PK		
103 CI	FLHX Electra Glide Special	16	HD-1614		RK-3938	RK-3901PK		
103 CI	FLHX Electra Glide Special	16	HD-1614		RK-3939	RK-3902PK		
103 CI	FLHX Electra Glide Special	16	HD-1614		RK-3941			
103 CI	FLHX Street Glide	12-13	HD-1508		63-1122*	RC-3680DK	KN-171C**	*Exc. Lower Fairings/ **Black=KN-171B
103 CI	FLHX Street Glide	12-13	HD-1508		63-1122P*	RC-3680DK	KN-171C**	*Exc. Lower Fairings/ **Black=KN-171B
103 CI	FLHX Street Glide	12-13	HD-1508		63-1131*		KN-171C**	*w/Lower Fairings/ **Black=KN-171B
103 CI	FLHX Street Glide	12-13	HD-1508		63-1131P*		KN-171C**	*w/Lower Fairings/ **Black=KN-171B
103 CI	FLHX Street Glide	12-13	HD-1508		63-1134*		KN-171C**	*Exc. Lower Fairings/ **Black=KN-171B
103 CI	FLHX Street Glide	12-13	HD-1508		63-1134S*		KN-171C**	*Exc. Lower Fairings/ **Black=KN-171B
103 CI	FLHX Street Glide	12-13	HD-1508		RK-3930		KN-171C*	*Black=KN-171B
103 CI	FLHX Street Glide	12-13	HD-1508		RK-3930X		KN-171C*	*Black=KN-171B
103 CI	FLHX Street Glide	12-13	HD-1508		RK-3936	RK-3901PK	KN-171C*	*Black=KN-171B
103 CI	FLHX Street Glide	12-13	HD-1508		RK-3937	RK-3902PK	KN-171C*	*Black=KN-171B
103 CI	FLHX Street Glide	12-13	HD-1508		RK-3938	RK-3901PK	KN-171C*	*Black=KN-171B
103 CI	FLHX Street Glide	12-13	HD-1508		RK-3939	RK-3902PK	KN-171C*	*Black=KN-171B
103 CI	FLHX Street Glide	12-13	HD-1508		RK-3946	HD-0800DK	KN-171C*	*Black=KN-171B
103 CI	FLHX Street Glide	12-13	HD-1508		RK-3946B	HD-0800DK	KN-171C*	*Black=KN-171B
103 CI	FLHX Street Glide	12-13	HD-1508		RK-3946X		KN-171C*	*Black=KN-171B
103 CI	FLHX Street Glide	12-13	HD-1508		RK-3946XB		KN-171C*	*Black=KN-171B
103 CI	FLHX Street Glide	12-13	HD-1508		RK-3947		KN-171C*	*Black=KN-171B
103 CI	FLHX Street Glide	12-13	HD-1508		RK-3947B		KN-171C*	*Black=KN-171B
103 CI	FLHX Street Glide	12-13	HD-1508		RK-3947X		KN-171C*	*Black=KN-171B
103 CI	FLHX Street Glide	12-13	HD-1508		RK-3947XB		KN-171C*	*Black=KN-171B
103 CI	FLHX Street Glide	12-13	HD-1508		RK-3951*		KN-171C**	*Exc. Lower Fairings/ **Black=KN-171B
103 CI	FLHX Street Glide	12-13	HD-1508		RK-3951S*		KN-171C**	*Exc. Lower Fairings/ **Black=KN-171B
103 CI	FLHX Street Glide	14-15	HD-1614		63-1122*	RC-3680DK	KN-171C**	*Exc. Lower Fairings/ **Black=KN-171B
103 CI	FLHX Street Glide	14-15	HD-1614		63-1122P*	RC-3680DK	KN-171C**	*Exc. Lower Fairings/ **Black=KN-171B
103 CI	FLHX Street Glide	14-15	HD-1614		63-1131*		KN-171C**	*w/Lower Fairings/ **Black=KN-171B
103 CI	FLHX Street Glide	14-15	HD-1614		63-1131P*		KN-171C**	*w/Lower Fairings/ **Black=KN-171B
103 CI	FLHX Street Glide	14-15	HD-1614		63-1134*		KN-171C**	*Exc. Lower Fairings/ **Black=KN-171B
103 CI	FLHX Street Glide	14-15	HD-1614		63-1134S*		KN-171C**	*Exc. Lower Fairings/ **Black=KN-171B
103 CI	FLHX Street Glide	14-15	HD-1614		RK-3946	HD-0800DK	KN-171C*	*Black=KN-171B

2) Requires Two; 3) Requires Three; 4) Requires Four. The use of custom air filter requires removal of air box. Some custom filters and intakes are not legal for sale or use on any pollution controlled motor vehicle in California or states adopting California emission procedures. See knfilters.com for CARB status on each part for a specific vehicle.

Motorcycle - Application Listing



CC	Model	Year	Air Filter	Air Filter Precharger	Custom	Custom Precharger	Oil Filter	Comments
HARLEY DAVIDSON								
103 CI	FLHX Street Glide	14-15	HD-1614		RK-3946B	HD-0800DK	KN-171C*	*Black=KN-171B
103 CI	FLHX Street Glide	14-15	HD-1614		RK-3946X		KN-171C*	*Black=KN-171B
103 CI	FLHX Street Glide	14-15	HD-1614		RK-3946XB		KN-171C*	*Black=KN-171B
103 CI	FLHX Street Glide	14-15	HD-1614		RK-3947		KN-171C*	*Black=KN-171B
103 CI	FLHX Street Glide	14-15	HD-1614		RK-3947B		KN-171C*	*Black=KN-171B
103 CI	FLHX Street Glide	14-15	HD-1614		RK-3947X		KN-171C*	*Black=KN-171B
103 CI	FLHX Street Glide	14-15	HD-1614		RK-3947XB		KN-171C*	*Black=KN-171B
103 CI	FLHX Street Glide	14-15	HD-1614		RK-3951*		KN-171C**	*Exc. Lower Fairings/ **Black=KN-171B
103 CI	FLHX Street Glide	14-15	HD-1614		RK-3951S*		KN-171C**	*Exc. Lower Fairings/ **Black=KN-171B
103 CI	FLHX Street Glide	14-16	HD-1614		RK-3936	RK-3901PK	KN-171C*	*Black=KN-171B
103 CI	FLHX Street Glide	14-16	HD-1614		RK-3937	RK-3902PK	KN-171C*	*Black=KN-171B
103 CI	FLHX Street Glide	14-16	HD-1614		RK-3938	RK-3901PK	KN-171C*	*Black=KN-171B
103 CI	FLHX Street Glide	14-16	HD-1614		RK-3939	RK-3902PK	KN-171C*	*Black=KN-171B
103 CI	FLHX Street Glide	14-16	HD-1614		RK-3941		KN-171C*	*Black=KN-171B
103 CI	FLHXS Street Glide Special	14-15	HD-1614		RK-3936	RK-3901PK	KN-171C*	*Black=KN-171B
103 CI	FLHXS Street Glide Special	14-15	HD-1614		RK-3937	RK-3902PK	KN-171C*	*Black=KN-171B
103 CI	FLHXS Street Glide Special	14-15	HD-1614		RK-3938	RK-3901PK	KN-171C*	*Black=KN-171B
103 CI	FLHXS Street Glide Special	14-15	HD-1614		RK-3939	RK-3902PK	KN-171C*	*Black=KN-171B
103 CI	FLHXS Street Glide Special	14-16	HD-1614		63-1122*	RC-3680DK	KN-171C**	*Exc. Lower Fairings/ **Black=KN-171B
103 CI	FLHXS Street Glide Special	14-16	HD-1614		63-1122P*	RC-3680DK	KN-171C**	*Exc. Lower Fairings/ **Black=KN-171B
103 CI	FLHXS Street Glide Special	14-16	HD-1614		63-1134*		KN-171C**	*Exc. Lower Fairings/ **Black=KN-171B
103 CI	FLHXS Street Glide Special	14-16	HD-1614		63-1134S*		KN-171C**	*Exc. Lower Fairings/ **Black=KN-171B
103 CI	FLHXS Street Glide Special	14-16	HD-1614		RK-3941		KN-171C*	*Black=KN-171B
103 CI	FLHXS Street Glide Special	14-16	HD-1614		RK-3951*		KN-171C**	*Exc. Lower Fairings/ **Black=KN-171B
103 CI	FLHXS Street Glide Special	14-16	HD-1614		RK-3951S*		KN-171C**	*Exc. Lower Fairings/ **Black=KN-171B
103 CI	FLHXS Street Glide Special	15	HD-1614		63-1131*		KN-171C**	*w/Lower Fairings/ **Black=KN-171B
103 CI	FLHXS Street Glide Special	15	HD-1614		63-1131P*		KN-171C**	*w/Lower Fairings/ **Black=KN-171B
103 CI	FLHXS Street Glide Special	15	HD-1614		RK-3946	HD-0800DK	KN-171C*	*Black=KN-171B
103 CI	FLHXS Street Glide Special	15	HD-1614		RK-3946B	HD-0800DK	KN-171C*	*Black=KN-171B
103 CI	FLHXS Street Glide Special	15	HD-1614		RK-3946X		KN-171C*	*Black=KN-171B
103 CI	FLHXS Street Glide Special	15	HD-1614		RK-3946XB		KN-171C*	*Black=KN-171B
103 CI	FLHXS Street Glide Special	15	HD-1614		RK-3947		KN-171C*	*Black=KN-171B
103 CI	FLHXS Street Glide Special	15	HD-1614		RK-3947B		KN-171C*	*Black=KN-171B
103 CI	FLHXS Street Glide Special	15	HD-1614		RK-3947X		KN-171C*	*Black=KN-171B
103 CI	FLHXS Street Glide Special	15	HD-1614		RK-3947XB		KN-171C*	*Black=KN-171B
103 CI	FLHXXX Street Glide Trike	10-11	HD-1508		63-1131*		KN-171C**	*w/Lower Fairings/ **Black=KN-171B
103 CI	FLHXXX Street Glide Trike	10-11	HD-1508		63-1131P*		KN-171C**	*w/Lower Fairings/ **Black=KN-171B
103 CI	FLHXXX Street Glide Trike	10-11	HD-1508		RK-3930		KN-171C*	*Black=KN-171B
103 CI	FLHXXX Street Glide Trike	10-11	HD-1508		RK-3930X		KN-171C*	*Black=KN-171B
103 CI	FLHXXX Street Glide Trike	10-11	HD-1508		RK-3936	RK-3901PK	KN-171C*	*Black=KN-171B
103 CI	FLHXXX Street Glide Trike	10-11	HD-1508		RK-3937	RK-3902PK	KN-171C*	*Black=KN-171B
103 CI	FLHXXX Street Glide Trike	10-11	HD-1508		RK-3938	RK-3901PK	KN-171C*	*Black=KN-171B
103 CI	FLHXXX Street Glide Trike	10-11	HD-1508		RK-3939	RK-3902PK	KN-171C*	*Black=KN-171B
103 CI	FLHXXX Street Glide Trike	10-11	HD-1508		RK-3946	HD-0800DK	KN-171C*	*Black=KN-171B
103 CI	FLHXXX Street Glide Trike	10-11	HD-1508		RK-3946B	HD-0800DK	KN-171C*	*Black=KN-171B
103 CI	FLHXXX Street Glide Trike	10-11	HD-1508		RK-3946X		KN-171C*	*Black=KN-171B
103 CI	FLHXXX Street Glide Trike	10-11	HD-1508		RK-3946XB		KN-171C*	*Black=KN-171B

2) Requires Two; 3) Requires Three; 4) Requires Four. The use of custom air filter requires removal of air box. Some custom filters and intakes are not legal for sale or use on any pollution controlled motor vehicle in California or states adopting California emission procedures. See knfilters.com for CARB status on each part for a specific vehicle.



Motorcycle - Application Listing

CC	Model	Year	Air Filter	Air Filter Precharger	Custom	Custom Precharger	Oil Filter	Comments
HARLEY DAVIDSON								
103 CI	FLHXXX Street Glide Trike	10-11	HD-1508		RK-3947		KN-171C*	*Black=KN-171B
103 CI	FLHXXX Street Glide Trike	10-11	HD-1508		RK-3947B		KN-171C*	*Black=KN-171B
103 CI	FLHXXX Street Glide Trike	10-11	HD-1508		RK-3947X		KN-171C*	*Black=KN-171B
103 CI	FLHXXX Street Glide Trike	10-11	HD-1508		RK-3947XB		KN-171C*	*Black=KN-171B
103 CI	FLRT Freewheeler	15	HD-1614		63-1131*		KN-171C**	*w/Lower Fairings/ **Black=KN-171B
103 CI	FLRT Freewheeler	15	HD-1614		63-1131P*		KN-171C**	*w/Lower Fairings/ **Black=KN-171B
103 CI	FLRT Freewheeler	15	HD-1614		RK-3946	HD-0800DK	KN-171C*	*Black=KN-171B
103 CI	FLRT Freewheeler	15	HD-1614		RK-3946B	HD-0800DK	KN-171C*	*Black=KN-171B
103 CI	FLRT Freewheeler	15	HD-1614		RK-3946X		KN-171C*	*Black=KN-171B
103 CI	FLRT Freewheeler	15	HD-1614		RK-3946XB		KN-171C*	*Black=KN-171B
103 CI	FLRT Freewheeler	15	HD-1614		RK-3947		KN-171C*	*Black=KN-171B
103 CI	FLRT Freewheeler	15	HD-1614		RK-3947B		KN-171C*	*Black=KN-171B
103 CI	FLRT Freewheeler	15	HD-1614		RK-3947X		KN-171C*	*Black=KN-171B
103 CI	FLRT Freewheeler	15	HD-1614		RK-3947XB		KN-171C*	*Black=KN-171B
103 CI	FLRT Freewheeler	15-16	HD-1614		63-1122*	RC-3680DK	KN-171C**	*Exc. Lower Fairings/ **Black=KN-171B
103 CI	FLRT Freewheeler	15-16	HD-1614		63-1122P*	RC-3680DK	KN-171C**	*Exc. Lower Fairings/ **Black=KN-171B
103 CI	FLRT Freewheeler	15-16	HD-1614		63-1134*		KN-171C**	*Exc. Lower Fairings/ **Black=KN-171B
103 CI	FLRT Freewheeler	15-16	HD-1614		63-1134S*		KN-171C**	*Exc. Lower Fairings/ **Black=KN-171B
103 CI	FLRT Freewheeler	15-16	HD-1614		RK-3936	RK-3901PK	KN-171C*	*Black=KN-171B
103 CI	FLRT Freewheeler	15-16	HD-1614		RK-3937	RK-3902PK	KN-171C*	*Black=KN-171B
103 CI	FLRT Freewheeler	15-16	HD-1614		RK-3938	RK-3901PK	KN-171C*	*Black=KN-171B
103 CI	FLRT Freewheeler	15-16	HD-1614		RK-3939	RK-3902PK	KN-171C*	*Black=KN-171B
103 CI	FLRT Freewheeler	15-16	HD-1614		RK-3941		KN-171C*	*Black=KN-171B
103 CI	FLRT Freewheeler	15-16	HD-1614		RK-3951*		KN-171C**	*Exc. Lower Fairings/ **Black=KN-171B
103 CI	FLRT Freewheeler	15-16	HD-1614		RK-3951S*		KN-171C**	*Exc. Lower Fairings/ **Black=KN-171B
103 CI	FLS Softail Slim	12-15	HD-1611		RK-3932		KN-171C*	*Black=KN-171B
103 CI	FLS Softail Slim	12-15	HD-1611		RK-3932B		KN-171C*	*Black=KN-171B
103 CI	FLS Softail Slim	12-15	HD-1611		RK-3932X		KN-171C*	*Black=KN-171B
103 CI	FLS Softail Slim	12-15	HD-1611		RK-3932XB		KN-171C*	*Black=KN-171B
103 CI	FLS Softail Slim	12-15	HD-1611		RK-3933	HD-0800DK	KN-171C*	*Black=KN-171B
103 CI	FLS Softail Slim	12-15	HD-1611		RK-3933B	HD-0800DK	KN-171C*	*Black=KN-171B
103 CI	FLS Softail Slim	12-15	HD-1611		RK-3933X		KN-171C*	*Black=KN-171B
103 CI	FLS Softail Slim	12-15	HD-1611		RK-3933XB		KN-171C*	*Black=KN-171B
103 CI	FLS Softail Slim	12-15	HD-1611		RK-3934	RK-3901PK	KN-171C*	*Black=KN-171B
103 CI	FLS Softail Slim	12-15	HD-1611		RK-3935	RK-3902PK	KN-171C*	*Black=KN-171B
103 CI	FLS Softail Slim	13-15	HD-1611		63-1125*	RC-3680DK	KN-171C**	*Exc. Lower Fairings/ **Black=KN-171B
103 CI	FLS Softail Slim	13-15	HD-1611		63-1125P*	RC-3680DK	KN-171C**	*Exc. Lower Fairings/ **Black=KN-171B
103 CI	FLS Softail Slim	13-15	HD-1611		63-1137*		KN-171C**	*Exc. Lower Fairings/ **Black=KN-171B
103 CI	FLS Softail Slim	13-15	HD-1611		63-1137S*		KN-171C**	*Exc. Lower Fairings/ **Black=KN-171B
103 CI	FLS Softail Slim	13-15	HD-1611		RK-3950*		KN-171C**	*Exc. Lower Fairings/ **Black=KN-171B
103 CI	FLS Softail Slim	13-15	HD-1611		RK-3950S*		KN-171C**	*Exc. Lower Fairings/ **Black=KN-171B
103 CI	FLS Softail Slim	16	HD-1614		63-1122*	RC-3680DK	KN-171C**	*Exc. Lower Fairings/ **Black=KN-171B
103 CI	FLS Softail Slim	16	HD-1614		63-1122P*	RC-3680DK	KN-171C**	*Exc. Lower Fairings/ **Black=KN-171B

2) Requires Two; 3) Requires Three; 4) Requires Four. The use of custom air filter requires removal of air box. Some custom filters and intakes are not legal for sale or use on any pollution controlled motor vehicle in California or states adopting California emission procedures. See knfilters.com for CARB status on each part for a specific vehicle.

Motorcycle - Application Listing



CC	Model	Year	Air Filter	Air Filter Precharger	Custom	Custom Precharger	Oil Filter	Comments
HARLEY DAVIDSON								
103 CI	FLS Softail Slim	16	HD-1614		63-1134*		KN-171C**	*Exc. Lower Fairings/ **Black=KN-171B
103 CI	FLS Softail Slim	16	HD-1614		63-1134S*		KN-171C**	*Exc. Lower Fairings/ **Black=KN-171B
103 CI	FLS Softail Slim	16	HD-1614		RK-3936	RK-3901PK	KN-171C*	*Black=KN-171B
103 CI	FLS Softail Slim	16	HD-1614		RK-3937	RK-3902PK	KN-171C*	*Black=KN-171B
103 CI	FLS Softail Slim	16	HD-1614		RK-3938	RK-3901PK	KN-171C*	*Black=KN-171B
103 CI	FLS Softail Slim	16	HD-1614		RK-3939	RK-3902PK	KN-171C*	*Black=KN-171B
103 CI	FLS Softail Slim	16	HD-1614		RK-3941		KN-171C*	*Black=KN-171B
103 CI	FLS Softail Slim	16	HD-1614		RK-3951*		KN-171C**	*Exc. Lower Fairings/ **Black=KN-171B
103 CI	FLS Softail Slim	16	HD-1614		RK-3951S*		KN-171C**	*Exc. Lower Fairings/ **Black=KN-171B
103 CI	FLS Softail Slim	17	HD-1614		63-1122*	RC-3680DK		*Exc. Lower Fairings
103 CI	FLS Softail Slim	17	HD-1614		63-1122P*	RC-3680DK		*Exc. Lower Fairings
103 CI	FLS Softail Slim	17	HD-1614		63-1134*			*Exc. Lower Fairings
103 CI	FLS Softail Slim	17	HD-1614		63-1134S*			*Exc. Lower Fairings
103 CI	FLS Softail Slim	17	HD-1614		RK-3936	RK-3901PK		
103 CI	FLS Softail Slim	17	HD-1614		RK-3937	RK-3902PK		
103 CI	FLS Softail Slim	17	HD-1614		RK-3938	RK-3901PK		
103 CI	FLS Softail Slim	17	HD-1614		RK-3939	RK-3902PK		
103 CI	FLS Softail Slim	17	HD-1614		RK-3941			
103 CI	FLS Softail Slim	17	HD-1614		RK-3951*			*Exc. Lower Fairings
103 CI	FLS Softail Slim	17	HD-1614		RK-3951S*			*Exc. Lower Fairings
103 CI	FLSTC Heritage Softail Classic	12	HD-1499		RK-3909-1*		KN-171C**	*w/1-5/8 inch Tall Filter/ **Black=KN-171B
103 CI	FLSTC Heritage Softail Classic	12	HD-1499		RK-3910-1*		KN-171C**	*w/2-1/4 inch Tall Filter/ **Black=KN-171B
103 CI	FLSTC Heritage Softail Classic	12-15	HD-1499		63-1125*	RC-3680DK	KN-171C**	*Exc. Lower Fairings/ **Black=KN-171B
103 CI	FLSTC Heritage Softail Classic	12-15	HD-1499		63-1125P*	RC-3680DK	KN-171C**	*Exc. Lower Fairings/ **Black=KN-171B
103 CI	FLSTC Heritage Softail Classic	12-15	HD-1499		63-1137*		KN-171C**	*Exc. Lower Fairings/ **Black=KN-171B
103 CI	FLSTC Heritage Softail Classic	12-15	HD-1499		63-1137S*		KN-171C**	*Exc. Lower Fairings/ **Black=KN-171B
103 CI	FLSTC Heritage Softail Classic	12-15	HD-1499		RK-3932		KN-171C*	*Black=KN-171B
103 CI	FLSTC Heritage Softail Classic	12-15	HD-1499		RK-3932B		KN-171C*	*Black=KN-171B
103 CI	FLSTC Heritage Softail Classic	12-15	HD-1499		RK-3932X		KN-171C*	*Black=KN-171B
103 CI	FLSTC Heritage Softail Classic	12-15	HD-1499		RK-3932XB		KN-171C*	*Black=KN-171B
103 CI	FLSTC Heritage Softail Classic	12-15	HD-1499		RK-3933	HD-0800DK	KN-171C*	*Black=KN-171B
103 CI	FLSTC Heritage Softail Classic	12-15	HD-1499		RK-3933B	HD-0800DK	KN-171C*	*Black=KN-171B
103 CI	FLSTC Heritage Softail Classic	12-15	HD-1499		RK-3933X		KN-171C*	*Black=KN-171B
103 CI	FLSTC Heritage Softail Classic	12-15	HD-1499		RK-3933XB		KN-171C*	*Black=KN-171B
103 CI	FLSTC Heritage Softail Classic	12-15	HD-1499		RK-3934	RK-3901PK	KN-171C*	*Black=KN-171B
103 CI	FLSTC Heritage Softail Classic	12-15	HD-1499		RK-3935	RK-3902PK	KN-171C*	*Black=KN-171B
103 CI	FLSTC Heritage Softail Classic	12-15	HD-1499		RK-3950*		KN-171C**	*Exc. Lower Fairings/ **Black=KN-171B
103 CI	FLSTC Heritage Softail Classic	12-15	HD-1499		RK-3950S*		KN-171C**	*Exc. Lower Fairings/ **Black=KN-171B
103 CI	FLSTC Heritage Softail Classic	13-15	HD-1499		RK-3942		KN-171C*	*Black=KN-171B
103 CI	FLSTC Heritage Softail Classic	16	HD-1614		63-1122*	RC-3680DK	KN-171C**	*Exc. Lower Fairings/ **Black=KN-171B
103 CI	FLSTC Heritage Softail Classic	16	HD-1614		63-1122P*	RC-3680DK	KN-171C**	*Exc. Lower Fairings/ **Black=KN-171B
103 CI	FLSTC Heritage Softail Classic	16	HD-1614		63-1134*		KN-171C**	*Exc. Lower Fairings/ **Black=KN-171B
103 CI	FLSTC Heritage Softail Classic	16	HD-1614		63-1134S*		KN-171C**	*Exc. Lower Fairings/ **Black=KN-171B
103 CI	FLSTC Heritage Softail Classic	16	HD-1614		RK-3936	RK-3901PK	KN-171C*	*Black=KN-171B

2) Requires Two; 3) Requires Three; 4) Requires Four. The use of custom air filter requires removal of air box. Some custom filters and intakes are not legal for sale or use on any pollution controlled motor vehicle in California or states adopting California emission procedures. See knfilters.com for CARB status on each part for a specific vehicle.



Motorcycle - Application Listing

CC	Model	Year	Air Filter	Air Filter Precharger	Custom	Custom Precharger	Oil Filter	Comments
HARLEY DAVIDSON								
103 CI	FLSTC Heritage Softail Classic	16	HD-1614		RK-3937	RK-3902PK	KN-171C*	*Black=KN-171B
103 CI	FLSTC Heritage Softail Classic	16	HD-1614		RK-3938	RK-3901PK	KN-171C*	*Black=KN-171B
103 CI	FLSTC Heritage Softail Classic	16	HD-1614		RK-3939	RK-3902PK	KN-171C*	*Black=KN-171B
103 CI	FLSTC Heritage Softail Classic	16	HD-1614		RK-3941		KN-171C*	*Black=KN-171B
103 CI	FLSTC Heritage Softail Classic	16	HD-1614		RK-3951*		KN-171C**	*Exc. Lower Fairings/ **Black=KN-171B
103 CI	FLSTC Heritage Softail Classic	16	HD-1614		RK-3951S*		KN-171C**	*Exc. Lower Fairings/ **Black=KN-171B
103 CI	FLSTC Heritage Softail Classic	17	HD-1614		63-1122*	RC-3680DK		*Exc. Lower Fairings
103 CI	FLSTC Heritage Softail Classic	17	HD-1614		63-1122P*	RC-3680DK		*Exc. Lower Fairings
103 CI	FLSTC Heritage Softail Classic	17	HD-1614		63-1134*			*Exc. Lower Fairings
103 CI	FLSTC Heritage Softail Classic	17	HD-1614		63-1134S*			*Exc. Lower Fairings
103 CI	FLSTC Heritage Softail Classic	17	HD-1614		RK-3936	RK-3901PK		
103 CI	FLSTC Heritage Softail Classic	17	HD-1614		RK-3937	RK-3902PK		
103 CI	FLSTC Heritage Softail Classic	17	HD-1614		RK-3938	RK-3901PK		
103 CI	FLSTC Heritage Softail Classic	17	HD-1614		RK-3939	RK-3902PK		
103 CI	FLSTC Heritage Softail Classic	17	HD-1614		RK-3941			
103 CI	FLSTC Heritage Softail Classic	17	HD-1614		RK-3951*			*Exc. Lower Fairings
103 CI	FLSTC Heritage Softail Classic	17	HD-1614		RK-3951S*			*Exc. Lower Fairings
103 CI	FLSTF Fat Boy	12	HD-1499		RK-3909-1*		KN-171C**	*w/1-5/8 inch Tall Filter/ **Black=KN-171B
103 CI	FLSTF Fat Boy	12	HD-1499		RK-3910-1*		KN-171C**	*w/2-1/4 inch Tall Filter/ **Black=KN-171B
103 CI	FLSTF Fat Boy	12-15	HD-1499		63-1125*	RC-3680DK	KN-171C**	*Exc. Lower Fairings/ **Black=KN-171B
103 CI	FLSTF Fat Boy	12-15	HD-1499		63-1125P*	RC-3680DK	KN-171C**	*Exc. Lower Fairings/ **Black=KN-171B
103 CI	FLSTF Fat Boy	12-15	HD-1499		63-1137*		KN-171C**	*Exc. Lower Fairings/ **Black=KN-171B
103 CI	FLSTF Fat Boy	12-15	HD-1499		63-1137S*		KN-171C**	*Exc. Lower Fairings/ **Black=KN-171B
103 CI	FLSTF Fat Boy	12-15	HD-1499		RK-3932		KN-171C*	*Black=KN-171B
103 CI	FLSTF Fat Boy	12-15	HD-1499		RK-3932B		KN-171C*	*Black=KN-171B
103 CI	FLSTF Fat Boy	12-15	HD-1499		RK-3932X		KN-171C*	*Black=KN-171B
103 CI	FLSTF Fat Boy	12-15	HD-1499		RK-3932XB		KN-171C*	*Black=KN-171B
103 CI	FLSTF Fat Boy	12-15	HD-1499		RK-3933	HD-0800DK	KN-171C*	*Black=KN-171B
103 CI	FLSTF Fat Boy	12-15	HD-1499		RK-3933B	HD-0800DK	KN-171C*	*Black=KN-171B
103 CI	FLSTF Fat Boy	12-15	HD-1499		RK-3933X		KN-171C*	*Black=KN-171B
103 CI	FLSTF Fat Boy	12-15	HD-1499		RK-3933XB		KN-171C*	*Black=KN-171B
103 CI	FLSTF Fat Boy	12-15	HD-1499		RK-3934	RK-3901PK	KN-171C*	*Black=KN-171B
103 CI	FLSTF Fat Boy	12-15	HD-1499		RK-3935	RK-3902PK	KN-171C*	*Black=KN-171B
103 CI	FLSTF Fat Boy	12-15	HD-1499		RK-3950*		KN-171C**	*Exc. Lower Fairings/ **Black=KN-171B
103 CI	FLSTF Fat Boy	12-15	HD-1499		RK-3950S*		KN-171C**	*Exc. Lower Fairings/ **Black=KN-171B
103 CI	FLSTF Fat Boy	13-15	HD-1499		RK-3942		KN-171C*	*Black=KN-171B
103 CI	FLSTF Fat Boy	16	HD-1614		63-1122*	RC-3680DK	KN-171C**	*Exc. Lower Fairings/ **Black=KN-171B
103 CI	FLSTF Fat Boy	16	HD-1614		63-1122P*	RC-3680DK	KN-171C**	*Exc. Lower Fairings/ **Black=KN-171B
103 CI	FLSTF Fat Boy	16	HD-1614		63-1134*		KN-171C**	*Exc. Lower Fairings/ **Black=KN-171B
103 CI	FLSTF Fat Boy	16	HD-1614		63-1134S*		KN-171C**	*Exc. Lower Fairings/ **Black=KN-171B
103 CI	FLSTF Fat Boy	16	HD-1614		RK-3936	RK-3901PK	KN-171C*	*Black=KN-171B
103 CI	FLSTF Fat Boy	16	HD-1614		RK-3937	RK-3902PK	KN-171C*	*Black=KN-171B
103 CI	FLSTF Fat Boy	16	HD-1614		RK-3938	RK-3901PK	KN-171C*	*Black=KN-171B
103 CI	FLSTF Fat Boy	16	HD-1614		RK-3939	RK-3902PK	KN-171C*	*Black=KN-171B
103 CI	FLSTF Fat Boy	16	HD-1614		RK-3941		KN-171C*	*Black=KN-171B

2) Requires Two; 3) Requires Three; 4) Requires Four. The use of custom air filter requires removal of air box. Some custom filters and intakes are not legal for sale or use on any pollution controlled motor vehicle in California or states adopting California emission procedures. See knfilters.com for CARB status on each part for a specific vehicle.

Motorcycle - Application Listing



CC	Model	Year	Air Filter	Air Filter Precharger	Custom	Custom Precharger	Oil Filter	Comments
HARLEY DAVIDSON								
103 CI	FLSTF Fat Boy	16	HD-1614		RK-3951*		KN-171C**	*Exc. Lower Fairings/ **Black=KN-171B
103 CI	FLSTF Fat Boy	16	HD-1614		RK-3951S*		KN-171C**	*Exc. Lower Fairings/ **Black=KN-171B
103 CI	FLSTF Fat Boy	17	HD-1614		63-1122*	RC-3680DK		*Exc. Lower Fairings
103 CI	FLSTF Fat Boy	17	HD-1614		63-1122P*	RC-3680DK		*Exc. Lower Fairings
103 CI	FLSTF Fat Boy	17	HD-1614		63-1134*			*Exc. Lower Fairings
103 CI	FLSTF Fat Boy	17	HD-1614		63-1134S*			*Exc. Lower Fairings
103 CI	FLSTF Fat Boy	17	HD-1614		RK-3936	RK-3901PK		
103 CI	FLSTF Fat Boy	17	HD-1614		RK-3937	RK-3902PK		
103 CI	FLSTF Fat Boy	17	HD-1614		RK-3938	RK-3901PK		
103 CI	FLSTF Fat Boy	17	HD-1614		RK-3939	RK-3902PK		
103 CI	FLSTF Fat Boy	17	HD-1614		RK-3941			
103 CI	FLSTF Fat Boy	17	HD-1614		RK-3951*			*Exc. Lower Fairings
103 CI	FLSTF Fat Boy	17	HD-1614		RK-3951S*			*Exc. Lower Fairings
103 CI	FLSTFB Softail Fat Boy Lo	12	HD-1499		RK-3909-1*		KN-171C**	*w/1-5/8 inch Tall Filter/ **Black=KN-171B
103 CI	FLSTFB Softail Fat Boy Lo	12	HD-1499		RK-3910-1*		KN-171C**	*w/2-1/4 inch Tall Filter/ **Black=KN-171B
103 CI	FLSTFB Softail Fat Boy Lo	12-15	HD-1499		63-1125*	RC-3680DK	KN-171C**	*Exc. Lower Fairings/ **Black=KN-171B
103 CI	FLSTFB Softail Fat Boy Lo	12-15	HD-1499		63-1125P*	RC-3680DK	KN-171C**	*Exc. Lower Fairings/ **Black=KN-171B
103 CI	FLSTFB Softail Fat Boy Lo	12-15	HD-1499		63-1137*		KN-171C**	*Exc. Lower Fairings/ **Black=KN-171B
103 CI	FLSTFB Softail Fat Boy Lo	12-15	HD-1499		63-1137S*		KN-171C**	*Exc. Lower Fairings/ **Black=KN-171B
103 CI	FLSTFB Softail Fat Boy Lo	12-15	HD-1499		RK-3932		KN-171C*	*Black=KN-171B
103 CI	FLSTFB Softail Fat Boy Lo	12-15	HD-1499		RK-3932B		KN-171C*	*Black=KN-171B
103 CI	FLSTFB Softail Fat Boy Lo	12-15	HD-1499		RK-3932X		KN-171C*	*Black=KN-171B
103 CI	FLSTFB Softail Fat Boy Lo	12-15	HD-1499		RK-3932XB		KN-171C*	*Black=KN-171B
103 CI	FLSTFB Softail Fat Boy Lo	12-15	HD-1499		RK-3933	HD-0800DK	KN-171C*	*Black=KN-171B
103 CI	FLSTFB Softail Fat Boy Lo	12-15	HD-1499		RK-3933B	HD-0800DK	KN-171C*	*Black=KN-171B
103 CI	FLSTFB Softail Fat Boy Lo	12-15	HD-1499		RK-3933X		KN-171C*	*Black=KN-171B
103 CI	FLSTFB Softail Fat Boy Lo	12-15	HD-1499		RK-3933XB		KN-171C*	*Black=KN-171B
103 CI	FLSTFB Softail Fat Boy Lo	12-15	HD-1499		RK-3934	RK-3901PK	KN-171C*	*Black=KN-171B
103 CI	FLSTFB Softail Fat Boy Lo	12-15	HD-1499		RK-3935	RK-3902PK	KN-171C*	*Black=KN-171B
103 CI	FLSTFB Softail Fat Boy Lo	12-15	HD-1499		RK-3950*		KN-171C**	*Exc. Lower Fairings/ **Black=KN-171B
103 CI	FLSTFB Softail Fat Boy Lo	12-15	HD-1499		RK-3950S*		KN-171C**	*Exc. Lower Fairings/ **Black=KN-171B
103 CI	FLSTFB Softail Fat Boy Lo	13-15	HD-1499		RK-3942		KN-171C*	*Black=KN-171B
103 CI	FLSTFB Softail Fat Boy Lo	16	HD-1614		63-1122*	RC-3680DK	KN-171C**	*Exc. Lower Fairings/ **Black=KN-171B
103 CI	FLSTFB Softail Fat Boy Lo	16	HD-1614		63-1122P*	RC-3680DK	KN-171C**	*Exc. Lower Fairings/ **Black=KN-171B
103 CI	FLSTFB Softail Fat Boy Lo	16	HD-1614		63-1134*		KN-171C**	*Exc. Lower Fairings/ **Black=KN-171B
103 CI	FLSTFB Softail Fat Boy Lo	16	HD-1614		63-1134S*		KN-171C**	*Exc. Lower Fairings/ **Black=KN-171B
103 CI	FLSTFB Softail Fat Boy Lo	16	HD-1614		RK-3936	RK-3901PK	KN-171C*	*Black=KN-171B
103 CI	FLSTFB Softail Fat Boy Lo	16	HD-1614		RK-3937	RK-3902PK	KN-171C*	*Black=KN-171B
103 CI	FLSTFB Softail Fat Boy Lo	16	HD-1614		RK-3938	RK-3901PK	KN-171C*	*Black=KN-171B
103 CI	FLSTFB Softail Fat Boy Lo	16	HD-1614		RK-3939	RK-3902PK	KN-171C*	*Black=KN-171B
103 CI	FLSTFB Softail Fat Boy Lo	16	HD-1614		RK-3941		KN-171C*	*Black=KN-171B
103 CI	FLSTFB Softail Fat Boy Lo	16	HD-1614		RK-3951*		KN-171C**	*Exc. Lower Fairings/ **Black=KN-171B
103 CI	FLSTFB Softail Fat Boy Lo	16	HD-1614		RK-3951S*		KN-171C**	*Exc. Lower Fairings/ **Black=KN-171B
103 CI	FLSTFB Softail Fat Boy Lo	17	HD-1614					

2) Requires Two; 3) Requires Three; 4) Requires Four. The use of custom air filter requires removal of air box. Some custom filters and intakes are not legal for sale or use on any pollution controlled motor vehicle in California or states adopting California emission procedures. See knfilters.com for CARB status on each part for a specific vehicle.



Motorcycle - Application Listing

CC	Model	Year	Air Filter	Air Filter Precharger	Custom	Custom Precharger	Oil Filter	Comments
HARLEY DAVIDSON								
103 CI	FLSTFSE Screamin Eagle Fat Boy	05	HD-0800	HD-0800DK			KN-171C*	*Black=KN-171B
103 CI	FLSTN Softail Deluxe	12	HD-1499		RK-3909-1*		KN-171C**	*w/1-5/8 inch Tall Filter/ **Black=KN-171B
103 CI	FLSTN Softail Deluxe	12	HD-1499		RK-3910-1*		KN-171C**	*w/2-1/4 inch Tall Filter/ **Black=KN-171B
103 CI	FLSTN Softail Deluxe	12-15	HD-1499		63-1125*	RC-3680DK	KN-171C**	*Exc. Lower Fairings/ **Black=KN-171B
103 CI	FLSTN Softail Deluxe	12-15	HD-1499		63-1125P*	RC-3680DK	KN-171C**	*Exc. Lower Fairings/ **Black=KN-171B
103 CI	FLSTN Softail Deluxe	12-15	HD-1499		63-1137*		KN-171C**	*Exc. Lower Fairings/ **Black=KN-171B
103 CI	FLSTN Softail Deluxe	12-15	HD-1499		63-1137S*		KN-171C**	*Exc. Lower Fairings/ **Black=KN-171B
103 CI	FLSTN Softail Deluxe	12-15	HD-1499		RK-3932		KN-171C*	*Black=KN-171B
103 CI	FLSTN Softail Deluxe	12-15	HD-1499		RK-3932B		KN-171C*	*Black=KN-171B
103 CI	FLSTN Softail Deluxe	12-15	HD-1499		RK-3932X		KN-171C*	*Black=KN-171B
103 CI	FLSTN Softail Deluxe	12-15	HD-1499		RK-3932XB		KN-171C*	*Black=KN-171B
103 CI	FLSTN Softail Deluxe	12-15	HD-1499		RK-3933	HD-0800DK	KN-171C*	*Black=KN-171B
103 CI	FLSTN Softail Deluxe	12-15	HD-1499		RK-3933B	HD-0800DK	KN-171C*	*Black=KN-171B
103 CI	FLSTN Softail Deluxe	12-15	HD-1499		RK-3933X		KN-171C*	*Black=KN-171B
103 CI	FLSTN Softail Deluxe	12-15	HD-1499		RK-3933XB		KN-171C*	*Black=KN-171B
103 CI	FLSTN Softail Deluxe	12-15	HD-1499		RK-3934	RK-3901PK	KN-171C*	*Black=KN-171B
103 CI	FLSTN Softail Deluxe	12-15	HD-1499		RK-3935	RK-3902PK	KN-171C*	*Black=KN-171B
103 CI	FLSTN Softail Deluxe	12-15	HD-1499		RK-3950*		KN-171C**	*Exc. Lower Fairings/ **Black=KN-171B
103 CI	FLSTN Softail Deluxe	12-15	HD-1499		RK-3950S*		KN-171C**	*Exc. Lower Fairings/ **Black=KN-171B
103 CI	FLSTN Softail Deluxe	13-15	HD-1499		RK-3942		KN-171C*	*Black=KN-171B
103 CI	FLSTN Softail Deluxe	16	HD-1614		63-1122*	RC-3680DK	KN-171C**	*Exc. Lower Fairings/ **Black=KN-171B
103 CI	FLSTN Softail Deluxe	16	HD-1614		63-1122P*	RC-3680DK	KN-171C**	*Exc. Lower Fairings/ **Black=KN-171B
103 CI	FLSTN Softail Deluxe	16	HD-1614		63-1134*		KN-171C**	*Exc. Lower Fairings/ **Black=KN-171B
103 CI	FLSTN Softail Deluxe	16	HD-1614		63-1134S*		KN-171C**	*Exc. Lower Fairings/ **Black=KN-171B
103 CI	FLSTN Softail Deluxe	16	HD-1614		RK-3936	RK-3901PK	KN-171C*	*Black=KN-171B
103 CI	FLSTN Softail Deluxe	16	HD-1614		RK-3937	RK-3902PK	KN-171C*	*Black=KN-171B
103 CI	FLSTN Softail Deluxe	16	HD-1614		RK-3938	RK-3901PK	KN-171C*	*Black=KN-171B
103 CI	FLSTN Softail Deluxe	16	HD-1614		RK-3939	RK-3902PK	KN-171C*	*Black=KN-171B
103 CI	FLSTN Softail Deluxe	16	HD-1614		RK-3941		KN-171C*	*Black=KN-171B
103 CI	FLSTN Softail Deluxe	16	HD-1614		RK-3951*		KN-171C**	*Exc. Lower Fairings/ **Black=KN-171B
103 CI	FLSTN Softail Deluxe	16	HD-1614		RK-3951S*		KN-171C**	*Exc. Lower Fairings/ **Black=KN-171B
103 CI	FLSTN Softail Deluxe	17	HD-1614		63-1122*	RC-3680DK		*Exc. Lower Fairings
103 CI	FLSTN Softail Deluxe	17	HD-1614		63-1122P*	RC-3680DK		*Exc. Lower Fairings
103 CI	FLSTN Softail Deluxe	17	HD-1614		63-1134*			*Exc. Lower Fairings
103 CI	FLSTN Softail Deluxe	17	HD-1614		63-1134S*			*Exc. Lower Fairings
103 CI	FLSTN Softail Deluxe	17	HD-1614		RK-3936	RK-3901PK		
103 CI	FLSTN Softail Deluxe	17	HD-1614		RK-3937	RK-3902PK		
103 CI	FLSTN Softail Deluxe	17	HD-1614		RK-3938	RK-3901PK		
103 CI	FLSTN Softail Deluxe	17	HD-1614		RK-3939	RK-3902PK		
103 CI	FLSTN Softail Deluxe	17	HD-1614		RK-3941			
103 CI	FLSTN Softail Deluxe	17	HD-1614		RK-3951*			*Exc. Lower Fairings
103 CI	FLSTN Softail Deluxe	17	HD-1614		RK-3951S*			*Exc. Lower Fairings
103 CI	FLTRU Road Glide Ultra	11-13	HD-1508		63-1131*		KN-171C**	*w/Lower Fairings/ **Black=KN-171B
103 CI	FLTRU Road Glide Ultra	11-13	HD-1508		63-1131P*		KN-171C**	*w/Lower Fairings/ **Black=KN-171B

2) Requires Two; 3) Requires Three; 4) Requires Four. The use of custom air filter requires removal of air box. Some custom filters and intakes are not legal for sale or use on any pollution controlled motor vehicle in California or states adopting California emission procedures. See knfilters.com for CARB status on each part for a specific vehicle.

Motorcycle - Application Listing



CC	Model	Year	Air Filter	Air Filter Precharger	Custom	Custom Precharger	Oil Filter	Comments
HARLEY DAVIDSON								
103 CI	FLTRU Road Glide Ultra	11-13	HD-1508		RK-3930		KN-171C*	*Black=KN-171B
103 CI	FLTRU Road Glide Ultra	11-13	HD-1508		RK-3930X		KN-171C*	*Black=KN-171B
103 CI	FLTRU Road Glide Ultra	11-13	HD-1508		RK-3936	RK-3901PK	KN-171C*	*Black=KN-171B
103 CI	FLTRU Road Glide Ultra	11-13	HD-1508		RK-3937	RK-3902PK	KN-171C*	*Black=KN-171B
103 CI	FLTRU Road Glide Ultra	11-13	HD-1508		RK-3938	RK-3901PK	KN-171C*	*Black=KN-171B
103 CI	FLTRU Road Glide Ultra	11-13	HD-1508		RK-3939	RK-3902PK	KN-171C*	*Black=KN-171B
103 CI	FLTRU Road Glide Ultra	11-13	HD-1508		RK-3946	HD-0800DK	KN-171C*	*Black=KN-171B
103 CI	FLTRU Road Glide Ultra	11-13	HD-1508		RK-3946B	HD-0800DK	KN-171C*	*Black=KN-171B
103 CI	FLTRU Road Glide Ultra	11-13	HD-1508		RK-3946X		KN-171C*	*Black=KN-171B
103 CI	FLTRU Road Glide Ultra	11-13	HD-1508		RK-3946XB		KN-171C*	*Black=KN-171B
103 CI	FLTRU Road Glide Ultra	11-13	HD-1508		RK-3947		KN-171C*	*Black=KN-171B
103 CI	FLTRU Road Glide Ultra	11-13	HD-1508		RK-3947B		KN-171C*	*Black=KN-171B
103 CI	FLTRU Road Glide Ultra	11-13	HD-1508		RK-3947X		KN-171C*	*Black=KN-171B
103 CI	FLTRU Road Glide Ultra	11-13	HD-1508		RK-3947XB		KN-171C*	*Black=KN-171B
103 CI	FLTRU Road Glide Ultra	16	HD-1614		RK-3941		KN-171C*	*Black=KN-171B
103 CI	FLTRX Road Glide	15	HD-1614		63-1131*		KN-171C**	*w/Lower Fairings/ **Black=KN-171B
103 CI	FLTRX Road Glide	15	HD-1614		63-1131P*		KN-171C**	*w/Lower Fairings/ **Black=KN-171B
103 CI	FLTRX Road Glide	15	HD-1614		RK-3946	HD-0800DK	KN-171C*	*Black=KN-171B
103 CI	FLTRX Road Glide	15	HD-1614		RK-3946B	HD-0800DK	KN-171C*	*Black=KN-171B
103 CI	FLTRX Road Glide	15	HD-1614		RK-3946X		KN-171C*	*Black=KN-171B
103 CI	FLTRX Road Glide	15	HD-1614		RK-3946XB		KN-171C*	*Black=KN-171B
103 CI	FLTRX Road Glide	15	HD-1614		RK-3947		KN-171C*	*Black=KN-171B
103 CI	FLTRX Road Glide	15	HD-1614		RK-3947B		KN-171C*	*Black=KN-171B
103 CI	FLTRX Road Glide	15	HD-1614		RK-3947X		KN-171C*	*Black=KN-171B
103 CI	FLTRX Road Glide	15	HD-1614		RK-3947XB		KN-171C*	*Black=KN-171B
103 CI	FLTRX Road Glide	15-16	HD-1614		63-1122*	RC-3680DK	KN-171C**	*Exc. Lower Fairings/ **Black=KN-171B
103 CI	FLTRX Road Glide	15-16	HD-1614		63-1122P*	RC-3680DK	KN-171C**	*Exc. Lower Fairings/ **Black=KN-171B
103 CI	FLTRX Road Glide	15-16	HD-1614		63-1134*		KN-171C**	*Exc. Lower Fairings/ **Black=KN-171B
103 CI	FLTRX Road Glide	15-16	HD-1614		63-1134S*		KN-171C**	*Exc. Lower Fairings/ **Black=KN-171B
103 CI	FLTRX Road Glide	15-16	HD-1614		RK-3936	RK-3901PK	KN-171C*	*Black=KN-171B
103 CI	FLTRX Road Glide	15-16	HD-1614		RK-3937	RK-3902PK	KN-171C*	*Black=KN-171B
103 CI	FLTRX Road Glide	15-16	HD-1614		RK-3938	RK-3901PK	KN-171C*	*Black=KN-171B
103 CI	FLTRX Road Glide	15-16	HD-1614		RK-3939	RK-3902PK	KN-171C*	*Black=KN-171B
103 CI	FLTRX Road Glide	15-16	HD-1614		RK-3941		KN-171C*	*Black=KN-171B
103 CI	FLTRX Road Glide	15-16	HD-1614		RK-3951*		KN-171C**	*Exc. Lower Fairings/ **Black=KN-171B
103 CI	FLTRX Road Glide	15-16	HD-1614		RK-3951S*		KN-171C**	*Exc. Lower Fairings/ **Black=KN-171B
103 CI	FLTRX Road Glide Custom	12-13	HD-1508		63-1122*	RC-3680DK	KN-171C**	*Exc. Lower Fairings/ **Black=KN-171B
103 CI	FLTRX Road Glide Custom	12-13	HD-1508		63-1122P*	RC-3680DK	KN-171C**	*Exc. Lower Fairings/ **Black=KN-171B
103 CI	FLTRX Road Glide Custom	12-13	HD-1508		63-1131*		KN-171C**	*w/Lower Fairings/ **Black=KN-171B
103 CI	FLTRX Road Glide Custom	12-13	HD-1508		63-1131P*		KN-171C**	*w/Lower Fairings/ **Black=KN-171B
103 CI	FLTRX Road Glide Custom	12-13	HD-1508		63-1134*		KN-171C**	*Exc. Lower Fairings/ **Black=KN-171B
103 CI	FLTRX Road Glide Custom	12-13	HD-1508		63-1134S*		KN-171C**	*Exc. Lower Fairings/ **Black=KN-171B
103 CI	FLTRX Road Glide Custom	12-13	HD-1508		RK-3930		KN-171C*	*Black=KN-171B
103 CI	FLTRX Road Glide Custom	12-13	HD-1508		RK-3930X		KN-171C*	*Black=KN-171B
103 CI	FLTRX Road Glide Custom	12-13	HD-1508		RK-3936	RK-3901PK	KN-171C*	*Black=KN-171B

2) Requires Two; 3) Requires Three; 4) Requires Four. The use of custom air filter requires removal of air box. Some custom filters and intakes are not legal for sale or use on any pollution controlled motor vehicle in California or states adopting California emission procedures. See knfilters.com for CARB status on each part for a specific vehicle.



Motorcycle - Application Listing

CC	Model	Year	Air Filter	Air Filter Precharger	Custom	Custom Precharger	Oil Filter	Comments
HARLEY DAVIDSON								
103 CI	FLTRX Road Glide Custom	12-13	HD-1508		RK-3937	RK-3902PK	KN-171C*	*Black=KN-171B
103 CI	FLTRX Road Glide Custom	12-13	HD-1508		RK-3938	RK-3901PK	KN-171C*	*Black=KN-171B
103 CI	FLTRX Road Glide Custom	12-13	HD-1508		RK-3939	RK-3902PK	KN-171C*	*Black=KN-171B
103 CI	FLTRX Road Glide Custom	12-13	HD-1508		RK-3946	HD-0800DK	KN-171C*	*Black=KN-171B
103 CI	FLTRX Road Glide Custom	12-13	HD-1508		RK-3946B	HD-0800DK	KN-171C*	*Black=KN-171B
103 CI	FLTRX Road Glide Custom	12-13	HD-1508		RK-3946X		KN-171C*	*Black=KN-171B
103 CI	FLTRX Road Glide Custom	12-13	HD-1508		RK-3946XB		KN-171C*	*Black=KN-171B
103 CI	FLTRX Road Glide Custom	12-13	HD-1508		RK-3947		KN-171C*	*Black=KN-171B
103 CI	FLTRX Road Glide Custom	12-13	HD-1508		RK-3947B		KN-171C*	*Black=KN-171B
103 CI	FLTRX Road Glide Custom	12-13	HD-1508		RK-3947X		KN-171C*	*Black=KN-171B
103 CI	FLTRX Road Glide Custom	12-13	HD-1508		RK-3947XB		KN-171C*	*Black=KN-171B
103 CI	FLTRX Road Glide Custom	12-13	HD-1508		RK-3951*		KN-171C**	*Exc. Lower Fairings/ **Black=KN-171B
103 CI	FLTRX Road Glide Custom	12-13	HD-1508		RK-3951S*		KN-171C**	*Exc. Lower Fairings/ **Black=KN-171B
103 CI	FLTRXS Road Glide Special	15	HD-1614		63-1131*		KN-171C**	*w/Lower Fairings/ **Black=KN-171B
103 CI	FLTRXS Road Glide Special	15	HD-1614		63-1131P*		KN-171C**	*w/Lower Fairings/ **Black=KN-171B
103 CI	FLTRXS Road Glide Special	15	HD-1614		RK-3946	HD-0800DK	KN-171C*	*Black=KN-171B
103 CI	FLTRXS Road Glide Special	15	HD-1614		RK-3946B	HD-0800DK	KN-171C*	*Black=KN-171B
103 CI	FLTRXS Road Glide Special	15	HD-1614		RK-3946X		KN-171C*	*Black=KN-171B
103 CI	FLTRXS Road Glide Special	15	HD-1614		RK-3946XB		KN-171C*	*Black=KN-171B
103 CI	FLTRXS Road Glide Special	15	HD-1614		RK-3947		KN-171C*	*Black=KN-171B
103 CI	FLTRXS Road Glide Special	15	HD-1614		RK-3947B		KN-171C*	*Black=KN-171B
103 CI	FLTRXS Road Glide Special	15	HD-1614		RK-3947X		KN-171C*	*Black=KN-171B
103 CI	FLTRXS Road Glide Special	15	HD-1614		RK-3947XB		KN-171C*	*Black=KN-171B
103 CI	FLTRXS Road Glide Special	15-16	HD-1614		63-1122*	RC-3680DK	KN-171C**	*Exc. Lower Fairings/ **Black=KN-171B
103 CI	FLTRXS Road Glide Special	15-16	HD-1614		63-1122P*	RC-3680DK	KN-171C**	*Exc. Lower Fairings/ **Black=KN-171B
103 CI	FLTRXS Road Glide Special	15-16	HD-1614		63-1134*		KN-171C**	*Exc. Lower Fairings/ **Black=KN-171B
103 CI	FLTRXS Road Glide Special	15-16	HD-1614		63-1134S*		KN-171C**	*Exc. Lower Fairings/ **Black=KN-171B
103 CI	FLTRXS Road Glide Special	15-16	HD-1614		RK-3936	RK-3901PK	KN-171C*	*Black=KN-171B
103 CI	FLTRXS Road Glide Special	15-16	HD-1614		RK-3937	RK-3902PK	KN-171C*	*Black=KN-171B
103 CI	FLTRXS Road Glide Special	15-16	HD-1614		RK-3938	RK-3901PK	KN-171C*	*Black=KN-171B
103 CI	FLTRXS Road Glide Special	15-16	HD-1614		RK-3939	RK-3902PK	KN-171C*	*Black=KN-171B
103 CI	FLTRXS Road Glide Special	15-16	HD-1614		RK-3941		KN-171C*	*Black=KN-171B
103 CI	FLTRXS Road Glide Special	15-16	HD-1614		RK-3951*		KN-171C**	*Exc. Lower Fairings/ **Black=KN-171B
103 CI	FLTRXS Road Glide Special	15-16	HD-1614		RK-3951S*		KN-171C**	*Exc. Lower Fairings/ **Black=KN-171B
103 CI	FXDB Dyna Street Bob	14-16	HD-1611		63-1125*	RC-3680DK	KN-171C**	*Exc. Lower Fairings/ **Black=KN-171B
103 CI	FXDB Dyna Street Bob	14-16	HD-1611		63-1125P*	RC-3680DK	KN-171C**	*Exc. Lower Fairings/ **Black=KN-171B
103 CI	FXDB Dyna Street Bob	14-16	HD-1611		63-1137*		KN-171C**	*Exc. Lower Fairings/ **Black=KN-171B
103 CI	FXDB Dyna Street Bob	14-16	HD-1611		63-1137S*		KN-171C**	*Exc. Lower Fairings/ **Black=KN-171B
103 CI	FXDB Dyna Street Bob	14-16	HD-1611		RK-3932		KN-171C*	*Black=KN-171B
103 CI	FXDB Dyna Street Bob	14-16	HD-1611		RK-3932B		KN-171C*	*Black=KN-171B
103 CI	FXDB Dyna Street Bob	14-16	HD-1611		RK-3932X		KN-171C*	*Black=KN-171B
103 CI	FXDB Dyna Street Bob	14-16	HD-1611		RK-3932XB		KN-171C*	*Black=KN-171B
103 CI	FXDB Dyna Street Bob	14-16	HD-1611		RK-3933	HD-0800DK	KN-171C*	*Black=KN-171B
103 CI	FXDB Dyna Street Bob	14-16	HD-1611		RK-3933B	HD-0800DK	KN-171C*	*Black=KN-171B
103 CI	FXDB Dyna Street Bob	14-16	HD-1611		RK-3933X		KN-171C*	*Black=KN-171B

2) Requires Two; 3) Requires Three; 4) Requires Four. The use of custom air filter requires removal of air box. Some custom filters and intakes are not legal for sale or use on any pollution controlled motor vehicle in California or states adopting California emission procedures. See knfilters.com for CARB status on each part for a specific vehicle.

Motorcycle - Application Listing



CC	Model	Year	Air Filter	Air Filter Precharger	Custom	Custom Precharger	Oil Filter	Comments
HARLEY DAVIDSON								
103 CI	FXDB Dyna Street Bob	14-16	HD-1611		RK-3933XB		KN-171C*	*Black=KN-171B
103 CI	FXDB Dyna Street Bob	14-16	HD-1611		RK-3934	RK-3901PK	KN-171C*	*Black=KN-171B
103 CI	FXDB Dyna Street Bob	14-16	HD-1611		RK-3935	RK-3902PK	KN-171C*	*Black=KN-171B
103 CI	FXDB Dyna Street Bob	14-16	HD-1611		RK-3950*		KN-171C**	*Exc. Lower Fairings/ **Black=KN-171B
103 CI	FXDB Dyna Street Bob	14-16	HD-1611		RK-3950S*		KN-171C**	*Exc. Lower Fairings/ **Black=KN-171B
103 CI	FXDB Dyna Street Bob	17	HD-1611		63-1125*	RC-3680DK		*Exc. Lower Fairings
103 CI	FXDB Dyna Street Bob	17	HD-1611		63-1125P*	RC-3680DK		*Exc. Lower Fairings
103 CI	FXDB Dyna Street Bob	17	HD-1611		63-1137*			*Exc. Lower Fairings
103 CI	FXDB Dyna Street Bob	17	HD-1611		63-1137S*			*Exc. Lower Fairings
103 CI	FXDB Dyna Street Bob	17	HD-1611		RK-3932			
103 CI	FXDB Dyna Street Bob	17	HD-1611		RK-3932B			
103 CI	FXDB Dyna Street Bob	17	HD-1611		RK-3932X			
103 CI	FXDB Dyna Street Bob	17	HD-1611		RK-3932XB			
103 CI	FXDB Dyna Street Bob	17	HD-1611		RK-3933	HD-0800DK		
103 CI	FXDB Dyna Street Bob	17	HD-1611		RK-3933B	HD-0800DK		
103 CI	FXDB Dyna Street Bob	17	HD-1611		RK-3933X			
103 CI	FXDB Dyna Street Bob	17	HD-1611		RK-3933XB			
103 CI	FXDB Dyna Street Bob	17	HD-1611		RK-3934	RK-3901PK		
103 CI	FXDB Dyna Street Bob	17	HD-1611		RK-3935	RK-3902PK		
103 CI	FXDB Dyna Street Bob	17	HD-1611		RK-3950*			*Exc. Lower Fairings
103 CI	FXDB Dyna Street Bob	17	HD-1611		RK-3950S*			*Exc. Lower Fairings
103 CI	FXDC Dyna Super Glide Custom	14	HD-9608		63-1125*	RC-3680DK	KN-171C**	*Exc. Lower Fairings/ **Black=KN-171B
103 CI	FXDC Dyna Super Glide Custom	14	HD-9608		63-1125P*	RC-3680DK	KN-171C**	*Exc. Lower Fairings/ **Black=KN-171B
103 CI	FXDC Dyna Super Glide Custom	14	HD-9608		63-1137*		KN-171C**	*Exc. Lower Fairings/ **Black=KN-171B
103 CI	FXDC Dyna Super Glide Custom	14	HD-9608		63-1137S*		KN-171C**	*Exc. Lower Fairings/ **Black=KN-171B
103 CI	FXDC Dyna Super Glide Custom	14	HD-9608		RK-3931		KN-171C*	*Black=KN-171B
103 CI	FXDC Dyna Super Glide Custom	14	HD-9608		RK-3932		KN-171C*	*Black=KN-171B
103 CI	FXDC Dyna Super Glide Custom	14	HD-9608		RK-3932B		KN-171C*	*Black=KN-171B
103 CI	FXDC Dyna Super Glide Custom	14	HD-9608		RK-3932X		KN-171C*	*Black=KN-171B
103 CI	FXDC Dyna Super Glide Custom	14	HD-9608		RK-3932XB		KN-171C*	*Black=KN-171B
103 CI	FXDC Dyna Super Glide Custom	14	HD-9608		RK-3933	HD-0800DK	KN-171C*	*Black=KN-171B
103 CI	FXDC Dyna Super Glide Custom	14	HD-9608		RK-3933B	HD-0800DK	KN-171C*	*Black=KN-171B
103 CI	FXDC Dyna Super Glide Custom	14	HD-9608		RK-3933X		KN-171C*	*Black=KN-171B
103 CI	FXDC Dyna Super Glide Custom	14	HD-9608		RK-3933XB		KN-171C*	*Black=KN-171B
103 CI	FXDC Dyna Super Glide Custom	14	HD-9608		RK-3934	RK-3901PK	KN-171C*	*Black=KN-171B
103 CI	FXDC Dyna Super Glide Custom	14	HD-9608		RK-3935	RK-3902PK	KN-171C*	*Black=KN-171B
103 CI	FXDC Dyna Super Glide Custom	14	HD-9608		RK-3950*		KN-171C**	*Exc. Lower Fairings/ **Black=KN-171B
103 CI	FXDC Dyna Super Glide Custom	14	HD-9608		RK-3950S*		KN-171C**	*Exc. Lower Fairings/ **Black=KN-171B
103 CI	FXDF Fat Bob	12-14	HD-9608		63-1125*	RC-3680DK	KN-171C**	*Exc. Lower Fairings/ **Black=KN-171B
103 CI	FXDF Fat Bob	12-14	HD-9608		63-1125P*	RC-3680DK	KN-171C**	*Exc. Lower Fairings/ **Black=KN-171B
103 CI	FXDF Fat Bob	12-14	HD-9608		63-1137*		KN-171C**	*Exc. Lower Fairings/ **Black=KN-171B
103 CI	FXDF Fat Bob	12-14	HD-9608		63-1137S*		KN-171C**	*Exc. Lower Fairings/ **Black=KN-171B
103 CI	FXDF Fat Bob	12-14	HD-9608		RK-3931		KN-171C*	*Black=KN-171B
103 CI	FXDF Fat Bob	12-14	HD-9608		RK-3932		KN-171C*	*Black=KN-171B
103 CI	FXDF Fat Bob	12-14	HD-9608		RK-3932B		KN-171C*	*Black=KN-171B
103 CI	FXDF Fat Bob	12-14	HD-9608		RK-3932X		KN-171C*	*Black=KN-171B
103 CI	FXDF Fat Bob	12-14	HD-9608		RK-3932XB		KN-171C*	*Black=KN-171B

2) Requires Two; 3) Requires Three; 4) Requires Four. The use of custom air filter requires removal of air box. Some custom filters and intakes are not legal for sale or use on any pollution controlled motor vehicle in California or states adopting California emission procedures. See knfilters.com for CARB status on each part for a specific vehicle.



Motorcycle - Application Listing

CC	Model	Year	Air Filter	Air Filter Precharger	Custom	Custom Precharger	Oil Filter	Comments
HARLEY DAVIDSON								
103 CI	FXDF Fat Bob	12-14	HD-9608		RK-3933	HD-0800DK	KN-171C*	*Black=KN-171B
103 CI	FXDF Fat Bob	12-14	HD-9608		RK-3933B	HD-0800DK	KN-171C*	*Black=KN-171B
103 CI	FXDF Fat Bob	12-14	HD-9608		RK-3933X		KN-171C*	*Black=KN-171B
103 CI	FXDF Fat Bob	12-14	HD-9608		RK-3933XB		KN-171C*	*Black=KN-171B
103 CI	FXDF Fat Bob	12-14	HD-9608		RK-3934	RK-3901PK	KN-171C*	*Black=KN-171B
103 CI	FXDF Fat Bob	12-14	HD-9608		RK-3935	RK-3902PK	KN-171C*	*Black=KN-171B
103 CI	FXDF Fat Bob	12-14	HD-9608		RK-3950*		KN-171C**	*Exc. Lower Fairings/ **Black=KN-171B
103 CI	FXDF Fat Bob	12-14	HD-9608		RK-3950S*		KN-171C**	*Exc. Lower Fairings/ **Black=KN-171B
103 CI	FXDF Fat Bob	15			63-1125*	RC-3680DK	KN-171C**	*Exc. Lower Fairings/ **Black=KN-171B
103 CI	FXDF Fat Bob	15			63-1125P*	RC-3680DK	KN-171C**	*Exc. Lower Fairings/ **Black=KN-171B
103 CI	FXDF Fat Bob	15			63-1137*		KN-171C**	*Exc. Lower Fairings/ **Black=KN-171B
103 CI	FXDF Fat Bob	15			63-1137S*		KN-171C**	*Exc. Lower Fairings/ **Black=KN-171B
103 CI	FXDF Fat Bob	15			RK-3931		KN-171C*	*Black=KN-171B
103 CI	FXDF Fat Bob	15			RK-3932		KN-171C*	*Black=KN-171B
103 CI	FXDF Fat Bob	15			RK-3932B		KN-171C*	*Black=KN-171B
103 CI	FXDF Fat Bob	15			RK-3932X		KN-171C*	*Black=KN-171B
103 CI	FXDF Fat Bob	15			RK-3932XB		KN-171C*	*Black=KN-171B
103 CI	FXDF Fat Bob	15			RK-3933	HD-0800DK	KN-171C*	*Black=KN-171B
103 CI	FXDF Fat Bob	15			RK-3933B	HD-0800DK	KN-171C*	*Black=KN-171B
103 CI	FXDF Fat Bob	15			RK-3933X		KN-171C*	*Black=KN-171B
103 CI	FXDF Fat Bob	15			RK-3933XB		KN-171C*	*Black=KN-171B
103 CI	FXDF Fat Bob	15			RK-3934	RK-3901PK	KN-171C*	*Black=KN-171B
103 CI	FXDF Fat Bob	15			RK-3935	RK-3902PK	KN-171C*	*Black=KN-171B
103 CI	FXDF Fat Bob	15			RK-3950*		KN-171C**	*Exc. Lower Fairings/ **Black=KN-171B
103 CI	FXDF Fat Bob	15			RK-3950S*		KN-171C**	*Exc. Lower Fairings/ **Black=KN-171B
103 CI	FXDF Fat Bob	16	HD-0910		63-1125*	RC-3680DK	KN-171C**	*Exc. Lower Fairings/ **Black=KN-171B
103 CI	FXDF Fat Bob	16	HD-0910		63-1125P*	RC-3680DK	KN-171C**	*Exc. Lower Fairings/ **Black=KN-171B
103 CI	FXDF Fat Bob	16	HD-0910		63-1137*		KN-171C**	*Exc. Lower Fairings/ **Black=KN-171B
103 CI	FXDF Fat Bob	16	HD-0910		63-1137S*		KN-171C**	*Exc. Lower Fairings/ **Black=KN-171B
103 CI	FXDF Fat Bob	16	HD-0910		RK-3931		KN-171C*	*Black=KN-171B
103 CI	FXDF Fat Bob	16	HD-0910		RK-3932		KN-171C*	*Black=KN-171B
103 CI	FXDF Fat Bob	16	HD-0910		RK-3932B		KN-171C*	*Black=KN-171B
103 CI	FXDF Fat Bob	16	HD-0910		RK-3932X		KN-171C*	*Black=KN-171B
103 CI	FXDF Fat Bob	16	HD-0910		RK-3932XB		KN-171C*	*Black=KN-171B
103 CI	FXDF Fat Bob	16	HD-0910		RK-3933	HD-0800DK	KN-171C*	*Black=KN-171B
103 CI	FXDF Fat Bob	16	HD-0910		RK-3933B	HD-0800DK	KN-171C*	*Black=KN-171B
103 CI	FXDF Fat Bob	16	HD-0910		RK-3933X		KN-171C*	*Black=KN-171B
103 CI	FXDF Fat Bob	16	HD-0910		RK-3933XB		KN-171C*	*Black=KN-171B
103 CI	FXDF Fat Bob	16	HD-0910		RK-3934	RK-3901PK	KN-171C*	*Black=KN-171B
103 CI	FXDF Fat Bob	16	HD-0910		RK-3935	RK-3902PK	KN-171C*	*Black=KN-171B
103 CI	FXDF Fat Bob	16	HD-0910		RK-3950*		KN-171C**	*Exc. Lower Fairings/ **Black=KN-171B
103 CI	FXDF Fat Bob	16	HD-0910		RK-3950S*		KN-171C**	*Exc. Lower Fairings/ **Black=KN-171B
103 CI	FXDF Fat Bob	17	HD-0910		63-1125*	RC-3680DK		*Exc. Lower Fairings
103 CI	FXDF Fat Bob	17	HD-0910		63-1125P*	RC-3680DK		*Exc. Lower Fairings
103 CI	FXDF Fat Bob	17	HD-0910		63-1137*			*Exc. Lower Fairings

2) Requires Two; 3) Requires Three; 4) Requires Four. The use of custom air filter requires removal of air box. Some custom filters and intakes are not legal for sale or use on any pollution controlled motor vehicle in California or states adopting California emission procedures. See knfilters.com for CARB status on each part for a specific vehicle.

Motorcycle - Application Listing



CC	Model	Year	Air Filter	Air Filter Precharger	Custom	Custom Precharger	Oil Filter	Comments
HARLEY DAVIDSON								
103 CI	FXDF Fat Bob	17	HD-0910		63-1137S*			*Exc. Lower Fairings
103 CI	FXDF Fat Bob	17	HD-0910		RK-3932			
103 CI	FXDF Fat Bob	17	HD-0910		RK-3932B			
103 CI	FXDF Fat Bob	17	HD-0910		RK-3932X			
103 CI	FXDF Fat Bob	17	HD-0910		RK-3932XB			
103 CI	FXDF Fat Bob	17	HD-0910		RK-3933	HD-0800DK		
103 CI	FXDF Fat Bob	17	HD-0910		RK-3933B	HD-0800DK		
103 CI	FXDF Fat Bob	17	HD-0910		RK-3933X			
103 CI	FXDF Fat Bob	17	HD-0910		RK-3933XB			
103 CI	FXDF Fat Bob	17	HD-0910		RK-3934	RK-3901PK		
103 CI	FXDF Fat Bob	17	HD-0910		RK-3935	RK-3902PK		
103 CI	FXDF Fat Bob	17	HD-0910		RK-3950*			*Exc. Lower Fairings
103 CI	FXDF Fat Bob	17	HD-0910		RK-3950S*			*Exc. Lower Fairings
103 CI	FXDF Fat Bob - Non-US	16	HD-9608				KN-171C*	*Black=KN-171B
103 CI	FXDL Dyna Low Rider	14-15	HD-9608		63-1125*	RC-3680DK	KN-171C**	*Exc. Lower Fairings/ **Black=KN-171B
103 CI	FXDL Dyna Low Rider	14-15	HD-9608		63-1125P*	RC-3680DK	KN-171C**	*Exc. Lower Fairings/ **Black=KN-171B
103 CI	FXDL Dyna Low Rider	14-15	HD-9608		63-1137*		KN-171C**	*Exc. Lower Fairings/ **Black=KN-171B
103 CI	FXDL Dyna Low Rider	14-15	HD-9608		63-1137S*		KN-171C**	*Exc. Lower Fairings/ **Black=KN-171B
103 CI	FXDL Dyna Low Rider	14-15	HD-9608		RK-3931		KN-171C*	*Black=KN-171B
103 CI	FXDL Dyna Low Rider	14-15	HD-9608		RK-3932		KN-171C*	*Black=KN-171B
103 CI	FXDL Dyna Low Rider	14-15	HD-9608		RK-3932B		KN-171C*	*Black=KN-171B
103 CI	FXDL Dyna Low Rider	14-15	HD-9608		RK-3932X		KN-171C*	*Black=KN-171B
103 CI	FXDL Dyna Low Rider	14-15	HD-9608		RK-3932XB		KN-171C*	*Black=KN-171B
103 CI	FXDL Dyna Low Rider	14-15	HD-9608		RK-3933	HD-0800DK	KN-171C*	*Black=KN-171B
103 CI	FXDL Dyna Low Rider	14-15	HD-9608		RK-3933B	HD-0800DK	KN-171C*	*Black=KN-171B
103 CI	FXDL Dyna Low Rider	14-15	HD-9608		RK-3933X		KN-171C*	*Black=KN-171B
103 CI	FXDL Dyna Low Rider	14-15	HD-9608		RK-3933XB		KN-171C*	*Black=KN-171B
103 CI	FXDL Dyna Low Rider	14-15	HD-9608		RK-3934	RK-3901PK	KN-171C*	*Black=KN-171B
103 CI	FXDL Dyna Low Rider	14-15	HD-9608		RK-3935	RK-3902PK	KN-171C*	*Black=KN-171B
103 CI	FXDL Dyna Low Rider	14-15	HD-9608		RK-3950*		KN-171C**	*Exc. Lower Fairings/ **Black=KN-171B
103 CI	FXDL Dyna Low Rider	14-15	HD-9608		RK-3950S*		KN-171C**	*Exc. Lower Fairings/ **Black=KN-171B
103 CI	FXDL Dyna Low Rider	16	HD-0910		63-1125*	RC-3680DK	KN-171C**	*Exc. Lower Fairings/ **Black=KN-171B
103 CI	FXDL Dyna Low Rider	16	HD-0910		63-1125P*	RC-3680DK	KN-171C**	*Exc. Lower Fairings/ **Black=KN-171B
103 CI	FXDL Dyna Low Rider	16	HD-0910		63-1137*		KN-171C**	*Exc. Lower Fairings/ **Black=KN-171B
103 CI	FXDL Dyna Low Rider	16	HD-0910		63-1137S*		KN-171C**	*Exc. Lower Fairings/ **Black=KN-171B
103 CI	FXDL Dyna Low Rider	16	HD-0910		RK-3931		KN-171C*	*Black=KN-171B
103 CI	FXDL Dyna Low Rider	16	HD-0910		RK-3932		KN-171C*	*Black=KN-171B
103 CI	FXDL Dyna Low Rider	16	HD-0910		RK-3932B		KN-171C*	*Black=KN-171B
103 CI	FXDL Dyna Low Rider	16	HD-0910		RK-3932X		KN-171C*	*Black=KN-171B
103 CI	FXDL Dyna Low Rider	16	HD-0910		RK-3932XB		KN-171C*	*Black=KN-171B
103 CI	FXDL Dyna Low Rider	16	HD-0910		RK-3933	HD-0800DK	KN-171C*	*Black=KN-171B
103 CI	FXDL Dyna Low Rider	16	HD-0910		RK-3933B	HD-0800DK	KN-171C*	*Black=KN-171B
103 CI	FXDL Dyna Low Rider	16	HD-0910		RK-3933X		KN-171C*	*Black=KN-171B
103 CI	FXDL Dyna Low Rider	16	HD-0910		RK-3933XB		KN-171C*	*Black=KN-171B
103 CI	FXDL Dyna Low Rider	16	HD-0910		RK-3934	RK-3901PK	KN-171C*	*Black=KN-171B
103 CI	FXDL Dyna Low Rider	16	HD-0910		RK-3935	RK-3902PK	KN-171C*	*Black=KN-171B
103 CI	FXDL Dyna Low Rider	16	HD-0910		RK-3950*		KN-171C**	*Exc. Lower Fairings/ **Black=KN-171B

2) Requires Two; 3) Requires Three; 4) Requires Four. The use of custom air filter requires removal of air box. Some custom filters and intakes are not legal for sale or use on any pollution controlled motor vehicle in California or states adopting California emission procedures. See knfilters.com for CARB status on each part for a specific vehicle.



Motorcycle - Application Listing

CC	Model	Year	Air Filter	Air Filter Precharger	Custom	Custom Precharger	Oil Filter	Comments
HARLEY DAVIDSON								
103 CI	FXDL Dyna Low Rider	16	HD-0910		RK-3950S*		KN-171C**	*Exc. Lower Fairings/ **Black=KN-171B
103 CI	FXDL Dyna Low Rider	17	HD-0910		63-1125*	RC-3680DK		*Exc. Lower Fairings
103 CI	FXDL Dyna Low Rider	17	HD-0910		63-1125P*	RC-3680DK		*Exc. Lower Fairings
103 CI	FXDL Dyna Low Rider	17	HD-0910		63-1137*			*Exc. Lower Fairings
103 CI	FXDL Dyna Low Rider	17	HD-0910		63-1137S*			*Exc. Lower Fairings
103 CI	FXDL Dyna Low Rider	17	HD-0910		RK-3932			
103 CI	FXDL Dyna Low Rider	17	HD-0910		RK-3932B			
103 CI	FXDL Dyna Low Rider	17	HD-0910		RK-3932X			
103 CI	FXDL Dyna Low Rider	17	HD-0910		RK-3932XB			
103 CI	FXDL Dyna Low Rider	17	HD-0910		RK-3933	HD-0800DK		
103 CI	FXDL Dyna Low Rider	17	HD-0910		RK-3933B	HD-0800DK		
103 CI	FXDL Dyna Low Rider	17	HD-0910		RK-3933X			
103 CI	FXDL Dyna Low Rider	17	HD-0910		RK-3933XB			
103 CI	FXDL Dyna Low Rider	17	HD-0910		RK-3934	RK-3901PK		
103 CI	FXDL Dyna Low Rider	17	HD-0910		RK-3935	RK-3902PK		
103 CI	FXDL Dyna Low Rider	17	HD-0910		RK-3950*			*Exc. Lower Fairings
103 CI	FXDL Dyna Low Rider	17	HD-0910		RK-3950S*			*Exc. Lower Fairings
103 CI	FXDL Dyna Low Rider - Non-US	16	HD-9608				KN-171C*	*Black=KN-171B
103 CI	FXDWG Dyna Wide Glide	12-15	HD-9608		63-1125*	RC-3680DK	KN-171C**	*Exc. Lower Fairings/ **Black=KN-171B
103 CI	FXDWG Dyna Wide Glide	12-15	HD-9608		63-1125P*	RC-3680DK	KN-171C**	*Exc. Lower Fairings/ **Black=KN-171B
103 CI	FXDWG Dyna Wide Glide	12-15	HD-9608		63-1137*		KN-171C**	*Exc. Lower Fairings/ **Black=KN-171B
103 CI	FXDWG Dyna Wide Glide	12-15	HD-9608		63-1137S*		KN-171C**	*Exc. Lower Fairings/ **Black=KN-171B
103 CI	FXDWG Dyna Wide Glide	12-15	HD-9608		RK-3931		KN-171C*	*Black=KN-171B
103 CI	FXDWG Dyna Wide Glide	12-15	HD-9608		RK-3932		KN-171C*	*Black=KN-171B
103 CI	FXDWG Dyna Wide Glide	12-15	HD-9608		RK-3932B		KN-171C*	*Black=KN-171B
103 CI	FXDWG Dyna Wide Glide	12-15	HD-9608		RK-3932X		KN-171C*	*Black=KN-171B
103 CI	FXDWG Dyna Wide Glide	12-15	HD-9608		RK-3932XB		KN-171C*	*Black=KN-171B
103 CI	FXDWG Dyna Wide Glide	12-15	HD-9608		RK-3933	HD-0800DK	KN-171C*	*Black=KN-171B
103 CI	FXDWG Dyna Wide Glide	12-15	HD-9608		RK-3933B	HD-0800DK	KN-171C*	*Black=KN-171B
103 CI	FXDWG Dyna Wide Glide	12-15	HD-9608		RK-3933X		KN-171C*	*Black=KN-171B
103 CI	FXDWG Dyna Wide Glide	12-15	HD-9608		RK-3933XB		KN-171C*	*Black=KN-171B
103 CI	FXDWG Dyna Wide Glide	12-15	HD-9608		RK-3934	RK-3901PK	KN-171C*	*Black=KN-171B
103 CI	FXDWG Dyna Wide Glide	12-15	HD-9608		RK-3935	RK-3902PK	KN-171C*	*Black=KN-171B
103 CI	FXDWG Dyna Wide Glide	12-15	HD-9608		RK-3950*		KN-171C**	*Exc. Lower Fairings/ **Black=KN-171B
103 CI	FXDWG Dyna Wide Glide	12-15	HD-9608		RK-3950S*		KN-171C**	*Exc. Lower Fairings/ **Black=KN-171B
103 CI	FXDWG Dyna Wide Glide	16	HD-0910		63-1125*	RC-3680DK	KN-171C**	*Exc. Lower Fairings/ **Black=KN-171B
103 CI	FXDWG Dyna Wide Glide	16	HD-0910		63-1125P*	RC-3680DK	KN-171C**	*Exc. Lower Fairings/ **Black=KN-171B
103 CI	FXDWG Dyna Wide Glide	16	HD-0910		63-1137*		KN-171C**	*Exc. Lower Fairings/ **Black=KN-171B
103 CI	FXDWG Dyna Wide Glide	16	HD-0910		63-1137S*		KN-171C**	*Exc. Lower Fairings/ **Black=KN-171B
103 CI	FXDWG Dyna Wide Glide	16	HD-0910		RK-3931		KN-171C*	*Black=KN-171B
103 CI	FXDWG Dyna Wide Glide	16	HD-0910		RK-3932		KN-171C*	*Black=KN-171B
103 CI	FXDWG Dyna Wide Glide	16	HD-0910		RK-3932B		KN-171C*	*Black=KN-171B
103 CI	FXDWG Dyna Wide Glide	16	HD-0910		RK-3932X		KN-171C*	*Black=KN-171B
103 CI	FXDWG Dyna Wide Glide	16	HD-0910		RK-3932XB		KN-171C*	*Black=KN-171B
103 CI	FXDWG Dyna Wide Glide	16	HD-0910		RK-3933	HD-0800DK	KN-171C*	*Black=KN-171B
103 CI	FXDWG Dyna Wide Glide	16	HD-0910		RK-3933B	HD-0800DK	KN-171C*	*Black=KN-171B
103 CI	FXDWG Dyna Wide Glide	16	HD-0910		RK-3933X		KN-171C*	*Black=KN-171B

2) Requires Two; 3) Requires Three; 4) Requires Four. The use of custom air filter requires removal of air box. Some custom filters and intakes are not legal for sale or use on any pollution controlled motor vehicle in California or states adopting California emission procedures. See knfilters.com for CARB status on each part for a specific vehicle.

Motorcycle - Application Listing



CC	Model	Year	Air Filter	Air Filter Precharger	Custom	Custom Precharger	Oil Filter	Comments
HARLEY DAVIDSON								
103 CI	FXDWG Dyna Wide Glide	16	HD-0910		RK-3933XB		KN-171C*	*Black=KN-171B
103 CI	FXDWG Dyna Wide Glide	16	HD-0910		RK-3934	RK-3901PK	KN-171C*	*Black=KN-171B
103 CI	FXDWG Dyna Wide Glide	16	HD-0910		RK-3935	RK-3902PK	KN-171C*	*Black=KN-171B
103 CI	FXDWG Dyna Wide Glide	16	HD-0910		RK-3950*		KN-171C**	*Exc. Lower Fairings/ **Black=KN-171B
103 CI	FXDWG Dyna Wide Glide	16	HD-0910		RK-3950S*		KN-171C**	*Exc. Lower Fairings/ **Black=KN-171B
103 CI	FXDWG Dyna Wide Glide	17	HD-0910		63-1125*	RC-3680DK		*Exc. Lower Fairings
103 CI	FXDWG Dyna Wide Glide	17	HD-0910		63-1125P*	RC-3680DK		*Exc. Lower Fairings
103 CI	FXDWG Dyna Wide Glide	17	HD-0910		63-1137*			*Exc. Lower Fairings
103 CI	FXDWG Dyna Wide Glide	17	HD-0910		63-1137S*			*Exc. Lower Fairings
103 CI	FXDWG Dyna Wide Glide	17	HD-0910		RK-3932			
103 CI	FXDWG Dyna Wide Glide	17	HD-0910		RK-3932B			
103 CI	FXDWG Dyna Wide Glide	17	HD-0910		RK-3932X			
103 CI	FXDWG Dyna Wide Glide	17	HD-0910		RK-3932XB			
103 CI	FXDWG Dyna Wide Glide	17	HD-0910		RK-3933	HD-0800DK		
103 CI	FXDWG Dyna Wide Glide	17	HD-0910		RK-3933B	HD-0800DK		
103 CI	FXDWG Dyna Wide Glide	17	HD-0910		RK-3933X			
103 CI	FXDWG Dyna Wide Glide	17	HD-0910		RK-3933XB			
103 CI	FXDWG Dyna Wide Glide	17	HD-0910		RK-3934	RK-3901PK		
103 CI	FXDWG Dyna Wide Glide	17	HD-0910		RK-3935	RK-3902PK		
103 CI	FXDWG Dyna Wide Glide	17	HD-0910		RK-3950*			*Exc. Lower Fairings
103 CI	FXDWG Dyna Wide Glide	17	HD-0910		RK-3950S*			*Exc. Lower Fairings
103 CI	FXDWG Dyna Wide Glide - Non-US	16	HD-9608				KN-171C*	*Black=KN-171B
103 CI	FXS Blackline	11-13	HD-1611		63-1125*	RC-3680DK	KN-171C**	*Exc. Lower Fairings/ **Black=KN-171B
103 CI	FXS Blackline	11-13	HD-1611		63-1125P*	RC-3680DK	KN-171C**	*Exc. Lower Fairings/ **Black=KN-171B
103 CI	FXS Blackline	11-13	HD-1611		63-1137*		KN-171C**	*Exc. Lower Fairings/ **Black=KN-171B
103 CI	FXS Blackline	11-13	HD-1611		63-1137S*		KN-171C**	*Exc. Lower Fairings/ **Black=KN-171B
103 CI	FXS Blackline	11-13	HD-1611		RK-3950*		KN-171C**	*Exc. Lower Fairings/ **Black=KN-171B
103 CI	FXS Blackline	11-13	HD-1611		RK-3950S*		KN-171C**	*Exc. Lower Fairings/ **Black=KN-171B
103 CI	FXS Blackline	12-13	HD-1611		RK-3932		KN-171C*	*Black=KN-171B
103 CI	FXS Blackline	12-13	HD-1611		RK-3932B		KN-171C*	*Black=KN-171B
103 CI	FXS Blackline	12-13	HD-1611		RK-3932X		KN-171C*	*Black=KN-171B
103 CI	FXS Blackline	12-13	HD-1611		RK-3932XB		KN-171C*	*Black=KN-171B
103 CI	FXS Blackline	12-13	HD-1611		RK-3933	HD-0800DK	KN-171C*	*Black=KN-171B
103 CI	FXS Blackline	12-13	HD-1611		RK-3933B	HD-0800DK	KN-171C*	*Black=KN-171B
103 CI	FXS Blackline	12-13	HD-1611		RK-3933X		KN-171C*	*Black=KN-171B
103 CI	FXS Blackline	12-13	HD-1611		RK-3933XB		KN-171C*	*Black=KN-171B
103 CI	FXS Blackline	12-13	HD-1611		RK-3934	RK-3901PK	KN-171C*	*Black=KN-171B
103 CI	FXS Blackline	12-13	HD-1611		RK-3935	RK-3902PK	KN-171C*	*Black=KN-171B
103 CI	FXSB Breakout	14-15	HD-1499		63-1125*	RC-3680DK	KN-171C**	*Exc. Lower Fairings/ **Black=KN-171B
103 CI	FXSB Breakout	14-15	HD-1499		63-1125P*	RC-3680DK	KN-171C**	*Exc. Lower Fairings/ **Black=KN-171B
103 CI	FXSB Breakout	14-15	HD-1499		63-1137*		KN-171C**	*Exc. Lower Fairings/ **Black=KN-171B
103 CI	FXSB Breakout	14-15	HD-1499		63-1137S*		KN-171C**	*Exc. Lower Fairings/ **Black=KN-171B
103 CI	FXSB Breakout	14-15	HD-1499		RK-3932		KN-171C*	*Black=KN-171B
103 CI	FXSB Breakout	14-15	HD-1499		RK-3932B		KN-171C*	*Black=KN-171B
103 CI	FXSB Breakout	14-15	HD-1499		RK-3932X		KN-171C*	*Black=KN-171B
103 CI	FXSB Breakout	14-15	HD-1499		RK-3932XB		KN-171C*	*Black=KN-171B
103 CI	FXSB Breakout	14-15	HD-1499		RK-3933	HD-0800DK	KN-171C*	*Black=KN-171B

2) Requires Two; 3) Requires Three; 4) Requires Four. The use of custom air filter requires removal of air box. Some custom filters and intakes are not legal for sale or use on any pollution controlled motor vehicle in California or states adopting California emission procedures. See knfilters.com for CARB status on each part for a specific vehicle.



Motorcycle - Application Listing

CC	Model	Year	Air Filter	Air Filter Precharger	Custom	Custom Precharger	Oil Filter	Comments
HARLEY DAVIDSON								
103 CI	FXSB Breakout	14-15	HD-1499		RK-3933B	HD-0800DK	KN-171C*	*Black=KN-171B
103 CI	FXSB Breakout	14-15	HD-1499		RK-3933X		KN-171C*	*Black=KN-171B
103 CI	FXSB Breakout	14-15	HD-1499		RK-3933XB		KN-171C*	*Black=KN-171B
103 CI	FXSB Breakout	14-15	HD-1499		RK-3934	RK-3901PK	KN-171C*	*Black=KN-171B
103 CI	FXSB Breakout	14-15	HD-1499		RK-3935	RK-3902PK	KN-171C*	*Black=KN-171B
103 CI	FXSB Breakout	14-15	HD-1499		RK-3942		KN-171C*	*Black=KN-171B
103 CI	FXSB Breakout	14-15	HD-1499		RK-3950*		KN-171C**	*Exc. Lower Fairings/ **Black=KN-171B
103 CI	FXSB Breakout	14-15	HD-1499		RK-3950S*		KN-171C**	*Exc. Lower Fairings/ **Black=KN-171B
103 CI	FXSB Breakout	16	HD-1614		63-1122*	RC-3680DK	KN-171C**	*Exc. Lower Fairings/ **Black=KN-171B
103 CI	FXSB Breakout	16	HD-1614		63-1122P*	RC-3680DK	KN-171C**	*Exc. Lower Fairings/ **Black=KN-171B
103 CI	FXSB Breakout	16	HD-1614		63-1134*		KN-171C**	*Exc. Lower Fairings/ **Black=KN-171B
103 CI	FXSB Breakout	16	HD-1614		63-1134S*		KN-171C**	*Exc. Lower Fairings/ **Black=KN-171B
103 CI	FXSB Breakout	16	HD-1614		RK-3936	RK-3901PK	KN-171C*	*Black=KN-171B
103 CI	FXSB Breakout	16	HD-1614		RK-3937	RK-3902PK	KN-171C*	*Black=KN-171B
103 CI	FXSB Breakout	16	HD-1614		RK-3938	RK-3901PK	KN-171C*	*Black=KN-171B
103 CI	FXSB Breakout	16	HD-1614		RK-3939	RK-3902PK	KN-171C*	*Black=KN-171B
103 CI	FXSB Breakout	16	HD-1614		RK-3941		KN-171C*	*Black=KN-171B
103 CI	FXSB Breakout	16	HD-1614		RK-3951*		KN-171C**	*Exc. Lower Fairings/ **Black=KN-171B
103 CI	FXSB Breakout	16	HD-1614		RK-3951S*		KN-171C**	*Exc. Lower Fairings/ **Black=KN-171B
103 CI	FXSB Breakout	17	HD-1614		63-1122*	RC-3680DK		*Exc. Lower Fairings
103 CI	FXSB Breakout	17	HD-1614		63-1122P*	RC-3680DK		*Exc. Lower Fairings
103 CI	FXSB Breakout	17	HD-1614		63-1134*			*Exc. Lower Fairings
103 CI	FXSB Breakout	17	HD-1614		63-1134S*			*Exc. Lower Fairings
103 CI	FXSB Breakout	17	HD-1614		RK-3936	RK-3901PK		
103 CI	FXSB Breakout	17	HD-1614		RK-3937	RK-3902PK		
103 CI	FXSB Breakout	17	HD-1614		RK-3938	RK-3901PK		
103 CI	FXSB Breakout	17	HD-1614		RK-3939	RK-3902PK		
103 CI	FXSB Breakout	17	HD-1614		RK-3941			
103 CI	FXSB Breakout	17	HD-1614		RK-3951*			*Exc. Lower Fairings
103 CI	FXSB Breakout	17	HD-1614		RK-3951S*			*Exc. Lower Fairings
103 CI	FXSBSE CVO Breakout	14			RK-3942		KN-171C*	*Black=KN-171B
107 CI	FLHR Road King	17	HD-1717		63-1138			
107 CI	FLHR Road King	17	HD-1717		63-1138C			
107 CI	FLHR Road King	17	HD-1717		RK-3949			
107 CI	FLHR Road King	17	HD-1717		RK-3949B			
107 CI	FLHR Road King	17	HD-1717		RK-3954			
107 CI	FLHR Road King	17	HD-1717		RK-3954B			
107 CI	FLHTCU Electra Glide Ultra Classic	17	HD-1717					
107 CI	FLHTCUTG Tri Glide Ultra	17	HD-1717		63-1138			
107 CI	FLHTCUTG Tri Glide Ultra	17	HD-1717		63-1138C			
107 CI	FLHTCUTG Tri Glide Ultra	17	HD-1717		RK-3949			
107 CI	FLHTCUTG Tri Glide Ultra	17	HD-1717		RK-3949B			
107 CI	FLHTCUTG Tri Glide Ultra	17	HD-1717		RK-3954			
107 CI	FLHTCUTG Tri Glide Ultra	17	HD-1717		RK-3954B			
107 CI	FLHTK Ultra Limited	17	HD-1717		63-1138			
107 CI	FLHTK Ultra Limited	17	HD-1717		63-1138C			
107 CI	FLHTK Ultra Limited	17	HD-1717		RK-3949			
107 CI	FLHTK Ultra Limited	17	HD-1717		RK-3949B			
107 CI	FLHTK Ultra Limited	17	HD-1717		RK-3954			
107 CI	FLHTK Ultra Limited	17	HD-1717		RK-3954B			

2) Requires Two; 3) Requires Three; 4) Requires Four. The use of custom air filter requires removal of air box. Some custom filters and intakes are not legal for sale or use on any pollution controlled motor vehicle in California or states adopting California emission procedures. See knfilters.com for CARB status on each part for a specific vehicle.

Motorcycle - Application Listing



CC	Model	Year	Air Filter	Air Filter Precharger	Custom	Custom Precharger	Oil Filter	Comments
HARLEY DAVIDSON								
107 CI	FLHTKL Ultra Limited Low	17	HD-1717		63-1138			
107 CI	FLHTKL Ultra Limited Low	17	HD-1717		63-1138C			
107 CI	FLHTKL Ultra Limited Low	17	HD-1717		RK-3949			
107 CI	FLHTKL Ultra Limited Low	17	HD-1717		RK-3949B			
107 CI	FLHTKL Ultra Limited Low	17	HD-1717		RK-3954			
107 CI	FLHTKL Ultra Limited Low	17	HD-1717		RK-3954B			
107 CI	FLHX Street Glide	17	HD-1717		63-1138			
107 CI	FLHX Street Glide	17	HD-1717		63-1138C			
107 CI	FLHX Street Glide	17	HD-1717		RK-3949			
107 CI	FLHX Street Glide	17	HD-1717		RK-3949B			
107 CI	FLHX Street Glide	17	HD-1717		RK-3954			
107 CI	FLHX Street Glide	17	HD-1717		RK-3954B			
107 CI	FLHXS Street Glide Special	17	HD-1717		63-1138			
107 CI	FLHXS Street Glide Special	17	HD-1717		63-1138C			
107 CI	FLHXS Street Glide Special	17	HD-1717		RK-3949			
107 CI	FLHXS Street Glide Special	17	HD-1717		RK-3949B			
107 CI	FLHXS Street Glide Special	17	HD-1717		RK-3954			
107 CI	FLHXS Street Glide Special	17	HD-1717		RK-3954B			
107 CI	FLRT Freewheeler	17	HD-1717		63-1138			
107 CI	FLRT Freewheeler	17	HD-1717		63-1138C			
107 CI	FLRT Freewheeler	17	HD-1717		RK-3949			
107 CI	FLRT Freewheeler	17	HD-1717		RK-3949B			
107 CI	FLRT Freewheeler	17	HD-1717		RK-3954			
107 CI	FLRT Freewheeler	17	HD-1717		RK-3954B			
107 CI	FLTRU Road Glide Ultra	17	HD-1717		63-1138			
107 CI	FLTRU Road Glide Ultra	17	HD-1717		63-1138C			
107 CI	FLTRU Road Glide Ultra	17	HD-1717		RK-3949			
107 CI	FLTRU Road Glide Ultra	17	HD-1717		RK-3949B			
107 CI	FLTRU Road Glide Ultra	17	HD-1717		RK-3954			
107 CI	FLTRU Road Glide Ultra	17	HD-1717		RK-3954B			
107 CI	FLTRX Road Glide	17	HD-1717		63-1138			
107 CI	FLTRX Road Glide	17	HD-1717		63-1138C			
107 CI	FLTRX Road Glide	17	HD-1717		RK-3949			
107 CI	FLTRX Road Glide	17	HD-1717		RK-3949B			
107 CI	FLTRX Road Glide	17	HD-1717		RK-3954			
107 CI	FLTRX Road Glide	17	HD-1717		RK-3954B			
107 CI	FLTRXS Road Glide Special	17	HD-1717		63-1138			
107 CI	FLTRXS Road Glide Special	17	HD-1717		63-1138C			
107 CI	FLTRXS Road Glide Special	17	HD-1717		RK-3949			
107 CI	FLTRXS Road Glide Special	17	HD-1717		RK-3949B			
107 CI	FLTRXS Road Glide Special	17	HD-1717		RK-3954			
107 CI	FLTRXS Road Glide Special	17	HD-1717		RK-3954B			
110 CI	FLHRSE3 Screamin Eagle Road King	07	HD-0800*	HD-0800DK			KN-171C**	*OEM 2944299A/B/C/D/ **Black=KN-171B
110 CI	FLHRSE4 Screamin Eagle Road King	08	HD-1508		63-1122*	RC-3680DK	KN-171C**	*Exc. Lower Fairings/ **Black=KN-171B
110 CI	FLHRSE4 Screamin Eagle Road King	08	HD-1508		63-1122P*	RC-3680DK	KN-171C**	*Exc. Lower Fairings/ **Black=KN-171B
110 CI	FLHRSE4 Screamin Eagle Road King	08	HD-1508		63-1134*		KN-171C**	*Exc. Lower Fairings/ **Black=KN-171B
110 CI	FLHRSE4 Screamin Eagle Road King	08	HD-1508		63-1134S*		KN-171C**	*Exc. Lower Fairings/ **Black=KN-171B
110 CI	FLHRSE4 Screamin Eagle Road King	08	HD-1508		RK-3930		KN-171C*	*Black=KN-171B
110 CI	FLHRSE4 Screamin Eagle Road King	08	HD-1508		RK-3930X		KN-171C*	*Black=KN-171B
110 CI	FLHRSE4 Screamin Eagle Road King	08	HD-1508		RK-3936	RK-3901PK	KN-171C*	*Black=KN-171B
110 CI	FLHRSE4 Screamin Eagle Road King	08	HD-1508		RK-3937	RK-3902PK	KN-171C*	*Black=KN-171B
110 CI	FLHRSE4 Screamin Eagle Road King	08	HD-1508		RK-3938	RK-3901PK	KN-171C*	*Black=KN-171B

2) Requires Two; 3) Requires Three; 4) Requires Four. The use of custom air filter requires removal of air box. Some custom filters and intakes are not legal for sale or use on any pollution controlled motor vehicle in California or states adopting California emission procedures. See knfilters.com for CARB status on each part for a specific vehicle.



Motorcycle - Application Listing

CC	Model	Year	Air Filter	Air Filter Precharger	Custom	Custom Precharger	Oil Filter	Comments
HARLEY DAVIDSON								
110 CI	FLHRSE4 Screamin Eagle Road King	08	HD-1508		RK-3939	RK-3902PK	KN-171C*	*Black=KN-171B
110 CI	FLHRSE4 Screamin Eagle Road King	08	HD-1508		RK-3951*		KN-171C**	*Exc. Lower Fairings/ **Black=KN-171B
110 CI	FLHRSE4 Screamin Eagle Road King	08	HD-1508		RK-3951S*		KN-171C**	*Exc. Lower Fairings/ **Black=KN-171B
110 CI	FLHRSE5 CVO Road King	13	HD-0910				KN-171C*	*Black=KN-171B
110 CI	FLHRSE6 CVO Road King	14					KN-171C*	*Black=KN-171B
110 CI	FLHSSE CVO Street Glide	16					KN-171C*	*Black=KN-171B
110 CI	FLHTCUSE2 Screamin Eagle Ultra Classic Electra Gl	07	HD-0800*	HD-0800DK			KN-171C**	*OEM 2944299A/B/C/D/ **Black=KN-171B
110 CI	FLHTCUSE3 Screamin Eagle Ultra Classic Electra Gl	08	HD-1508				KN-171C*	*Black=KN-171B
110 CI	FLHTCUSE4 CVO Ultra Classic Electra Glide	09	HD-1508				KN-171C*	*Black=KN-171B
110 CI	FLHTCUSE5 CVO Ultra Classic Electra Glide	10	HD-1508		RK-3930		KN-171C*	*Black=KN-171B
110 CI	FLHTCUSE5 CVO Ultra Classic Electra Glide	10	HD-1508		RK-3930X		KN-171C*	*Black=KN-171B
110 CI	FLHTCUSE5 CVO Ultra Classic Electra Glide	10	HD-1508		RK-3936	RK-3901PK	KN-171C*	*Black=KN-171B
110 CI	FLHTCUSE5 CVO Ultra Classic Electra Glide	10	HD-1508		RK-3937	RK-3902PK	KN-171C*	*Black=KN-171B
110 CI	FLHTCUSE5 CVO Ultra Classic Electra Glide	10	HD-1508		RK-3938	RK-3901PK	KN-171C*	*Black=KN-171B
110 CI	FLHTCUSE5 CVO Ultra Classic Electra Glide	10	HD-1508		RK-3939	RK-3902PK	KN-171C*	*Black=KN-171B
110 CI	FLHTCUSE6 CVO Ultra Classic Electra Glide	11	HD-0910				KN-171C*	*Black=KN-171B
110 CI	FLHTCUSE7 CVO Ultra Classic Electra Glide	12	HD-0910				KN-171C*	*Black=KN-171B
110 CI	FLHTCUSE8 CVO Ultra Classic Electra Glide F/I	13	HD-0910				KN-171C*	*Black=KN-171B
110 CI	FLHTKSE CVO Limited	14-16	HD-0910				KN-171C*	*Black=KN-171B
110 CI	FLHXSE CVO Street Glide	10	HD-0910				KN-171C*	*Black=KN-171B
110 CI	FLHXSE CVO Street Glide	15	HD-0910				KN-171C*	*Black=KN-171B
110 CI	FLHXSE CVO Street Glide	16	HD-0910				KN-171C*	*Black=KN-171B
110 CI	FLHXSE2 CVO Street Glide	11	HD-0910				KN-171C*	*Black=KN-171B
110 CI	FLHXSE3 CVO Street Glide	12	HD-0910				KN-171C*	*Black=KN-171B
110 CI	FLSS Softail Slim S	16			63-1122*	RC-3680DK	KN-171C**	*Exc. Lower Fairings/ **Black=KN-171B
110 CI	FLSS Softail Slim S	16			63-1122P*	RC-3680DK	KN-171C**	*Exc. Lower Fairings/ **Black=KN-171B
110 CI	FLSS Softail Slim S	16			63-1134*		KN-171C**	*Exc. Lower Fairings/ **Black=KN-171B
110 CI	FLSS Softail Slim S	16			63-1134S*		KN-171C**	*Exc. Lower Fairings/ **Black=KN-171B
110 CI	FLSS Softail Slim S	16			RK-3936	RK-3901PK	KN-171C*	*Black=KN-171B
110 CI	FLSS Softail Slim S	16			RK-3937	RK-3902PK	KN-171C*	*Black=KN-171B
110 CI	FLSS Softail Slim S	16			RK-3938	RK-3901PK	KN-171C*	*Black=KN-171B
110 CI	FLSS Softail Slim S	16			RK-3939	RK-3902PK	KN-171C*	*Black=KN-171B
110 CI	FLSS Softail Slim S	16			RK-3951*		KN-171C**	*Exc. Lower Fairings/ **Black=KN-171B
110 CI	FLSS Softail Slim S	16			RK-3951S*		KN-171C**	*Exc. Lower Fairings/ **Black=KN-171B
110 CI	FLSS Softail Slim S	17			63-1122*	RC-3680DK		*Exc. Lower Fairings
110 CI	FLSS Softail Slim S	17			63-1122P*	RC-3680DK		*Exc. Lower Fairings
110 CI	FLSS Softail Slim S	17			63-1134*			*Exc. Lower Fairings
110 CI	FLSS Softail Slim S	17			63-1134S*			*Exc. Lower Fairings
110 CI	FLSS Softail Slim S	17			RK-3936	RK-3901PK		
110 CI	FLSS Softail Slim S	17			RK-3937	RK-3902PK		
110 CI	FLSS Softail Slim S	17			RK-3938	RK-3901PK		
110 CI	FLSS Softail Slim S	17			RK-3939	RK-3902PK		
110 CI	FLSS Softail Slim S	17			RK-3941			
110 CI	FLSS Softail Slim S	17			RK-3951*			*Exc. Lower Fairings
110 CI	FLSS Softail Slim S	17			RK-3951S*			*Exc. Lower Fairings
110 CI	FLSTFBS Fat Boy S	16			63-1122*	RC-3680DK	KN-171C**	*Exc. Lower Fairings/ **Black=KN-171B

2) Requires Two; 3) Requires Three; 4) Requires Four. The use of custom air filter requires removal of air box. Some custom filters and intakes are not legal for sale or use on any pollution controlled motor vehicle in California or states adopting California emission procedures. See knfilters.com for CARB status on each part for a specific vehicle.

Motorcycle - Application Listing



CC	Model	Year	Air Filter	Air Filter Precharger	Custom	Custom Precharger	Oil Filter	Comments
HARLEY DAVIDSON								
110 CI	FLSTFBS Fat Boy S	16			63-1122P*	RC-3680DK	KN-171C**	*Exc. Lower Fairings/ **Black=KN-171B
110 CI	FLSTFBS Fat Boy S	16			63-1134*		KN-171C**	*Exc. Lower Fairings/ **Black=KN-171B
110 CI	FLSTFBS Fat Boy S	16			63-1134S*		KN-171C**	*Exc. Lower Fairings/ **Black=KN-171B
110 CI	FLSTFBS Fat Boy S	16			RK-3936	RK-3901PK	KN-171C*	*Black=KN-171B
110 CI	FLSTFBS Fat Boy S	16			RK-3937	RK-3902PK	KN-171C*	*Black=KN-171B
110 CI	FLSTFBS Fat Boy S	16			RK-3938	RK-3901PK	KN-171C*	*Black=KN-171B
110 CI	FLSTFBS Fat Boy S	16			RK-3939	RK-3902PK	KN-171C*	*Black=KN-171B
110 CI	FLSTFBS Fat Boy S	16			RK-3951*		KN-171C**	*Exc. Lower Fairings/ **Black=KN-171B
110 CI	FLSTFBS Fat Boy S	16			RK-3951S*		KN-171C**	*Exc. Lower Fairings/ **Black=KN-171B
110 CI	FLSTFBS Fat Boy S	17			63-1122*	RC-3680DK		*Exc. Lower Fairings
110 CI	FLSTFBS Fat Boy S	17			63-1122P*	RC-3680DK		*Exc. Lower Fairings
110 CI	FLSTFBS Fat Boy S	17			63-1134*			*Exc. Lower Fairings
110 CI	FLSTFBS Fat Boy S	17			63-1134S*			*Exc. Lower Fairings
110 CI	FLSTFBS Fat Boy S	17			RK-3936	RK-3901PK		
110 CI	FLSTFBS Fat Boy S	17			RK-3937	RK-3902PK		
110 CI	FLSTFBS Fat Boy S	17			RK-3938	RK-3901PK		
110 CI	FLSTFBS Fat Boy S	17			RK-3939	RK-3902PK		
110 CI	FLSTFBS Fat Boy S	17			RK-3941			
110 CI	FLSTFBS Fat Boy S	17			RK-3951*			*Exc. Lower Fairings
110 CI	FLSTFBS Fat Boy S	17			RK-3951S*			*Exc. Lower Fairings
110 CI	FLSTNSE CVO Softail Deluxe	14-15	HD-0910				KN-171C*	*Black=KN-171B
110 CI	FLSTSE CVO Softail Convertible	10-12	HD-0910				KN-171C*	*Black=KN-171B
110 CI	FLTRSE3 CVO Road Glide	09	HD-0910				KN-171C*	*Black=KN-171B
110 CI	FLTRUSE CVO Road Glide Ultra	11	HD-0910				KN-171C*	*Black=KN-171B
110 CI	FLTRUSE CVO Road Glide Ultra	15-16	HD-0910				KN-171C*	*Black=KN-171B
110 CI	FXDFSE CVO Fat Bob	09	HD-1499*				KN-171C**	*Non-US/ **Black=KN-171B
110 CI	FXDLS Low Rider S	16					KN-171C*	*Black=KN-171B
110 CI	FXDLS Low Rider S	17			63-1125*	RC-3680DK		*Exc. Lower Fairings
110 CI	FXDLS Low Rider S	17			63-1125P*	RC-3680DK		*Exc. Lower Fairings
110 CI	FXDLS Low Rider S	17			63-1137*			*Exc. Lower Fairings
110 CI	FXDLS Low Rider S	17			63-1137S*			*Exc. Lower Fairings
110 CI	FXDLS Low Rider S	17			RK-3932			
110 CI	FXDLS Low Rider S	17			RK-3932B			
110 CI	FXDLS Low Rider S	17			RK-3932X			
110 CI	FXDLS Low Rider S	17			RK-3932XB			
110 CI	FXDLS Low Rider S	17			RK-3933	HD-0800DK		
110 CI	FXDLS Low Rider S	17			RK-3933B	HD-0800DK		
110 CI	FXDLS Low Rider S	17			RK-3933X			
110 CI	FXDLS Low Rider S	17			RK-3933XB			
110 CI	FXDLS Low Rider S	17			RK-3934	RK-3901PK		
110 CI	FXDLS Low Rider S	17			RK-3935	RK-3902PK		
110 CI	FXDLS Low Rider S	17			RK-3950*			*Exc. Lower Fairings
110 CI	FXDLS Low Rider S	17			RK-3950S*			*Exc. Lower Fairings
110 CI	FXDSE Screamin Eagle Dyna	07	HD-0800*	HD-0800DK			KN-171C**	*OEM 2944299A/B/C/D/ **Black=KN-171B
110 CI	FXDSE2 Screamin Eagle Dyna	08	HD-0800*	HD-0800DK			KN-171C**	*US/ **Black=KN-171B
110 CI	FXSB Breakout	13			RK-3942			
110 CI	FXSBSE CVO Breakout	13			RK-3942		KN-171C*	*Black=KN-171B
110 CI	FXSTSSE Screamin Eagle Softail Springer	07	HD-0800*	HD-0800DK			KN-171C**	*OEM 2944299A/B/C/D/ **Black=KN-171B
110 CI	FXSTSSE2 Screamin Eagle Softail Springer	08					KN-171C*	*Black=KN-171B
110 CI	FXSTSSE3 CVO Softail Springer	09	HD-1499				KN-171C*	*Black=KN-171B

2) Requires Two; 3) Requires Three; 4) Requires Four. The use of custom air filter requires removal of air box. Some custom filters and intakes are not legal for sale or use on any pollution controlled motor vehicle in California or states adopting California emission procedures. See knfilters.com for CARB status on each part for a specific vehicle.



Motorcycle - Application Listing

CC	Model	Year	Air Filter	Air Filter Precharger	Custom	Custom Precharger	Oil Filter	Comments
HONDA								
49	CB50R Dream 50	04					KN-566	
50	CHF50 Metropolitan	02-09	HA-0502					
50	Z50A	72-78			R-1040	22-8008PK		
50	Z50R	79-99			R-1040	22-8008PK		
50	Z50RD	86			R-1040	22-8008PK		
70	SL70	71-73			RU-0060	22-8008PK		
75	XL75 Mini	77-79	HA-0300					
75	XR75 Mini	73-78	HA-0300		RU-0070	22-8009PK		
80	CR80R	86-89	HA-8086					
80	CRF80F	04-09	HA-1088	22-8008PK				
80	CRF80F	11-13	HA-1088	22-8008PK				
80	XR80 Mini	79			RU-0070	22-8009PK		
80	XR80R	85-03	HA-1088	22-8008PK				
82	CR80R	90-02	HA-8086					
85	CR85R	03-04	HA-8086					
85	CR85R Expert	03-04	HA-8086					
86	CR85R	05-07	HA-8086					
86	CR85R Expert	05-07	HA-8086					
100	CB100 Super Sport	70-71	HA-0300					
100	CL100 Scrambler	70-71	HA-0300					
100	CL100S Scrambler	70-71	HA-0300					
100	CRF100F	04-09	HA-1088	22-8008PK				
100	CRF100F	11-13	HA-1088	22-8008PK				
100	SL100	70-73	HA-0300					
100	XL100	74-78	HA-0300					
100	XR100R	85-03	HA-1088	22-8008PK				
110	NHX110	10	HA-1010					
121	VT125C Shadow	05-08					KN-113	
125	CB125	74-75	HA-0300					
125	CBR125R	03-16	HA-1502					
125	CR125R	81-84	HA-1100					
125	CR125R	90-01	HA-2591	HA-2591DK				
125	Grom 125	14-15	HA-1313					
125	Grom 125	17	HA-1313					
125	MSX125	13-16	HA-1313					
125	NES125	00-06	HA-1510					
125	PCX125	10-12	HA-1211					
125	PCX125	13-14	HA-1213					
125	PES125	06-10	HA-1510					
125	RS125 Nova Sonic	01-02	HA-1202					
125	SES125	02-04	HA-1510					
125	SL125	70-74	HA-0300					
125	VT125C Shadow	99-04					KN-113	
125	XL125V Varadero	01-10					KN-113	
125	XL125V Varadero De Luxe	11					KN-113	
150	CBR150R	02	HA-1502					
150	CRF150F	03-09	HA-1503					
150	CRF150F	12-14	HA-1503				KN-116	
150	CRF150F	15-17	HA-1503					
150	CRF150R	07-16	HA-1507	E-3043DK			KN-116	
150	CRF150R	17	HA-1507	E-3043DK				
150	CRF150R Expert	07-14	HA-1507	E-3043DK			KN-116	
150	CRF150R Expert	15	HA-1507	E-3043DK				
150	CRF150R Expert	16	HA-1507	E-3043DK			KN-116	
150	NES150	00-06	HA-1510					

2) Requires Two; 3) Requires Three; 4) Requires Four. The use of custom air filter requires removal of air box. Some custom filters and intakes are not legal for sale or use on any pollution controlled motor vehicle in California or states adopting California emission procedures. See knfilters.com for CARB status on each part for a specific vehicle.

Motorcycle - Application Listing



CC	Model	Year	Air Filter	Air Filter Precharger	Custom	Custom Precharger	Oil Filter	Comments
HONDA								
150	NSR150	98-01	HA-1598					
150	PES150	06-10	HA-1510					
150	PS150i	11-12	HA-1510					
150	SES150	02-04	HA-1510					
175	XL175	72-76			RU-1050	RU-0520PK		
200	Phantom 200	00	HA-2000					
200	XR200R	81-83	HA-1050					
200	XR200R	84-02	HA-2584	HA-1315PR				
230	CRF230F	03-09	HA-1503					
230	CRF230F	12-17	HA-1503					
234	CMX250C Rebel	96-97	HA-2596					
234	CMX250C Rebel	99-09	HA-2596					
234	CMX250C Rebel	12-14	HA-2596					
234	CMX250C Rebel	15	HA-2596				KN-204*	*Chrome=KN-204C
234	CMX250C Rebel	16	HA-2596					
249	CBR250R	11-13	HA-2511				KN-112	
249	CBR250R ABS	13	HA-2511				KN-112	
249	CRF250X	12-16	HA-2505XD				KN-116	
249	CRF250X	17	HA-2505XD					
250	250 AX1	ALL					KN-112	
250	CB250	78-82					KN-111	
250	CB250 RSA	80-83					KN-111	
250	CB250 RSD	82-84					KN-111	
250	CB250 Superdream	81-85					KN-111	
250	CBF250	04-06					KN-113	
250	CBX250 RSE	83-00					KN-112	
250	CM250TB Custom	81-85					KN-111	
250	CR250R	81-84	HA-1100					
250	CR250R	85	HA-1185					
250	CR250R	91-01	HA-2591	HA-2591DK				
250	CRF250L	13-15	HA-2513				KN-112	
250	CRF250L	16	HA-2513					
250	CRF250M	14	HA-2513					
250	CRF250M	15	HA-2513				KN-112	
250	CRF250M	16	HA-2513					
250	CRF250R	04-09	HA-4503XD	HA-4503DK			KN-116	
250	CRF250R	10-13	HA-4509XD				KN-116	
250	CRF250R	14-16	HA-4513XD				KN-116	
250	CRF250R	17	HA-4513XD					
250	CRF250X	04-09	HA-2505XD				KN-116	
250	FES250 Foresight	98-99	HA-2500-1					
250	NES250 Jazz	01	HA-2500-1					
250	NX250	88-95					KN-112	
250	TLR250	85-87					KN-112	
250	VT250	83-87					KN-111	
250	VT250 Integra	86-88					KN-111	
250	VT250 Spada	89-90					KN-111	
250	VTR250 Interceptor	88-90					KN-111	
250	XL250	88-91					KN-112	
250	XL250 ProLink	82-83					KN-112	
250	XL250 R Baja	91					KN-112	
250	XL250R	84-87					KN-112	
250	XLX250	83-84					KN-112	
250	XR250	79-80			RU-1050	RU-0520PK		
250	XR250 Super	97-04					KN-112	

2) Requires Two; 3) Requires Three; 4) Requires Four. The use of custom air filter requires removal of air box. Some custom filters and intakes are not legal for sale or use on any pollution controlled motor vehicle in California or states adopting California emission procedures. See knfilters.com for CARB status on each part for a specific vehicle.



Motorcycle - Application Listing

CC	Model	Year	Air Filter	Air Filter Precharger	Custom	Custom Precharger	Oil Filter	Comments
HONDA								
250	XR250L	91-99	HA-1312	HA-1312PR			KN-112	
250	XR250R	81	HA-1000		RU-1050	RU-0520PK		
250	XR250R	82	HA-1000		RU-1050	RU-0520PK	KN-112	
250	XR250R	83					KN-112	
250	XR250R	84-85	HA-2584	HA-1315PR			KN-112	
250	XR250R	86-04	HA-1312	HA-1312PR			KN-112	
286	CB300F	15-16	HA-2511				KN-112	
286	CBR300R	15-16	HA-2511				KN-112	
286	CBR300R ABS	15-16	HA-2511				KN-112	
350	CB350 Twin	68-72			RC-0412*	RU-0210PK		*Inc. 2 Filters
350	CB350F	72-74			RC-0794*	RC-0790PK	KN-401	*Inc. 4 Filters
350	CB350G Super Sport	73			RC-0794*	RC-0790PK	KN-401	*Inc. 4 Filters
350	CB350K Super Sport	73			RC-0794*	RC-0790PK	KN-401	*Inc. 4 Filters
350	CB350S	86-89					KN-111	
350	CL350 Twin	68-72			RC-0412*	RU-0210PK		*Inc. 2 Filters
350	XL350	73-75			RU-1070	25-1770		
350	XL350	73-75			RU-1070	RU-0520PK		
350	XL350R	84-87					KN-112	
350	XR350R	83-85	HA-1312	HA-1312PR			KN-112	
350	XR350R	86-87					KN-112	
397	XR400R	04	HA-1314	HA-1315PR			KN-112	
399	VFR400R - NC30	90-92					KN-303*	*Chrome=KN-303C
400	CB400	82-84					KN-111	
400	CB400 - NC31	ALL					KN-303*	*Chrome=KN-303C
400	CB400 Hawk	78-81					KN-111	
400	CB400 Super Dream	78-80					KN-111	
400	CB400 Super Four	97					KN-303*	*Chrome=KN-303C
400	CB400 Super Four	02					KN-303*	*Chrome=KN-303C
400	CB400 Super Four	ALL					KN-303*	*Chrome=KN-303C
400	CB400 VTEC	98	HA-4098				KN-113	
400	CB400 VTEC	99-00	HA-4098					
400	CB400A Hondamatic	78-83					KN-111	
400	CB400F	75-77			RC-0794*	RC-0790PK	KN-401	*Inc. 4 Filters
400	CB400F	78-79					KN-401	
400	CB400F	90					KN-303*	*Chrome=KN-303C
400	CB400F CB-1	89-92					KN-303*	*Chrome=KN-303C
400	CB400RR - NC29	91-93					KN-303*	*Chrome=KN-303C
400	CB400SF	00	HA-4020					
400	CBR400 Tri-Arm/Gull-Arm	ALL					KN-303*	*Chrome=KN-303C
400	CBR400RG Aero	ALL					KN-202	
400	CBX400 F	83-86					KN-111	
400	CM400 T Chopper	81-83					KN-111	
400	CM400A	79-81	HA-0850				KN-111	
400	CM400C	81	HA-0850				KN-111	
400	CM400E	80-81	HA-0850				KN-111	
400	CM400T	79-81	HA-0850				KN-111	
400	CX400 EC	82-84					KN-111	
400	FJS400	09-11					KN-204*	*Chrome=KN-204C
400	FJS400 Silver Wing	06-09					KN-204*	*Chrome=KN-204C
400	GB400F2	ALL					KN-112	
400	NT400 Bros	88-92					KN-303*	*Chrome=KN-303C
400	RVF400	99					KN-303*	*Chrome=KN-303C
400	VF400FD	83-86					KN-202	
400	VFR400 Pro-Arm	87-89					KN-303*	*Chrome=KN-303C
400	VFR400R	87					KN-303*	*Chrome=KN-303C

2) Requires Two; 3) Requires Three; 4) Requires Four. The use of custom air filter requires removal of air box. Some custom filters and intakes are not legal for sale or use on any pollution controlled motor vehicle in California or states adopting California emission procedures. See knfilters.com for CARB status on each part for a specific vehicle.

Motorcycle - Application Listing



CC	Model	Year	Air Filter	Air Filter Precharger	Custom	Custom Precharger	Oil Filter	Comments
HONDA								
400	VFR400R - NC30	93					KN-303*	*Chrome=KN-303C
400	XR400R	96-03	HA-1314	HA-1315PR			KN-112	
440	XR440 R/SM	96-04					KN-112	
444	CRF450R	02	HA-4502				KN-116	
444	CRF450R	03-08	HA-4503XD	HA-4503DK			KN-116	
444	CRF450R	09-12	HA-4509XD				KN-116	
444	CRF450X	05-09	HA-2505XD				KN-116	
449	CRF450R	13-16	HA-4513XD				KN-116	
449	CRF450X	12-16	HA-2505XD				KN-116	
449	CRF450X	17	HA-2505XD					
450	CB450DXK	89-92					KN-111	
450	CB450NF	85					KN-111	
450	CB450SC	82-83	HA-0850				KN-111	
450	CB450SC	85	HA-0850				KN-111	
450	CB450SC	86					KN-111	
450	CB450SG	86-88					KN-111	
450	CM450A Hondamatic	82-83	HA-0850				KN-111	
450	CM450C Custom	82	HA-0850				KN-111	
450	CM450E	82-83	HA-0850				KN-111	
450	CMX450C Rebel	86-87					KN-111	
450	CR450R	81	HA-1100					
471	CB500F	13-16	HA-5013				KN-204*	*Chrome=KN-204C
471	CB500F ABS	13-16	HA-5013				KN-204*	*Chrome=KN-204C
471	CB500X	13-16	HA-5013				KN-204*	*Chrome=KN-204C
471	CB500X ABS	13-16	HA-5013				KN-204*	*Chrome=KN-204C
471	CBR500R	13-16	HA-5013				KN-204*	*Chrome=KN-204C
471	CBR500R ABS	13-16	HA-5013				KN-204*	*Chrome=KN-204C
480	CR480R	82-83	HA-1100					
499	GB500	90					KN-112	
500	CB500 Cup	99					KN-303*	*Chrome=KN-303C
500	CB500 F Four	72-77					KN-401	
500	CB500K	71-73			RC-0840 ²	RU-0150PK	KN-401	
500	CB500K	74					KN-401	
500	CB500T	74			RC-0840 ²	RU-0150PK		
500	CB500T	75-76			RC-0840 ²	RU-0150PK	KN-111	
500	CB500T	77					KN-111	
500	CBF500	04-06	HA-6098				KN-303*	*Chrome=KN-303C
500	CBF500	07-08					KN-303*	*Chrome=KN-303C
500	CBF500 ABS	04-08					KN-303*	*Chrome=KN-303C
500	CR500R	85	HA-1185					
500	CR500R	89-01	HA-2591	HA-2591DK				
500	CX500	78-79	HA-0700				KN-111	
500	CX500	80-84					KN-111	
500	CX500 EC Eurosport	82-84					KN-111	
500	CX500C Custom	79-82	HA-0700				KN-111	
500	CX500C Custom	83-84					KN-111	
500	CX500D Deluxe	79-81	HA-0700				KN-111	
500	CX500TC Turbo	82-83					KN-111	
500	GB500	89					KN-112	
500	GL500 Silver Wing	81-82					KN-111	
500	GL500i Silver Wing Interstate	81-82	HA-0700				KN-111	
500	VF500C V30 Magna	84-85	HA-3010				KN-202	
500	VF500F Interceptor	84-86	HA-3084				KN-202	
500	VF500F Interceptor	87					KN-202	
500	VT500 ED Eurosport	83-85					KN-202	

2) Requires Two; 3) Requires Three; 4) Requires Four. The use of custom air filter requires removal of air box. Some custom filters and intakes are not legal for sale or use on any pollution controlled motor vehicle in California or states adopting California emission procedures. See knfilters.com for CARB status on each part for a specific vehicle.



Motorcycle - Application Listing

CC	Model	Year	Air Filter	Air Filter Precharger	Custom	Custom Precharger	Oil Filter	Comments
HONDA								
500	VT500 EF Eurosport	86-88					KN-202	
500	VT500C Shadow	83-86	HA-5083				KN-202	
500	VT500C Shadow	87-88					KN-202	
500	VT500FT Ascot	83-84	HA-5083				KN-202	
500	VT500FT Ascot	85-88					KN-202	
500	XBR500	85-88					KN-112	
500	XR500	81-85					KN-112	
500	XR500R	81-82	HA-1000				KN-112	
500	XR500R	83-84	HA-1303				KN-112	
502	CB500	94-99	HA-5094				KN-303*	*Chrome=KN-303C
502	CB500	00-02					KN-303*	*Chrome=KN-303C
550	CB550	75-76					KN-401	
550	CB550F Super Sport	75					KN-401	
550	CB550F Super Sport	76-77			RC-0844*	RU-0150PK	KN-401	*Inc. 4 Filters
550	CB550K	74					KN-401	
550	CB550K	75-76			RC-0844*	RU-0150PK	KN-401	*Inc. 4 Filters
550	CB550K	77-80					KN-401	
550	CB550SC Nighthawk	82					KN-401	
550	CB550SC Nighthawk	83	HA-5583				KN-401	
550	CBX550	81-86					KN-111	
583	XL600V Transalp	90-99	HA-6089				KN-303*	*Chrome=KN-303C
583	XL600V Transalp	00					KN-303*	*Chrome=KN-303C
599	599	04	HA-6098				KN-204*	*Chrome=KN-204C
599	599	06	HA-6098				KN-204*	*Chrome=KN-204C
599	CB600F	07	HA-5907				KN-204*	*Chrome=KN-204C
599	CB600F Hornet	08-13	HA-5907				KN-204*	*Chrome=KN-204C
599	CBF600	04-06	HA-6098				KN-204*	*Chrome=KN-204C
599	CBF600	07-13	HA-5907				KN-204*	*Chrome=KN-204C
599	CBF600S	04-06	HA-6098				KN-204*	*Chrome=KN-204C
599	CBF600S	07-11	HA-5907				KN-204*	*Chrome=KN-204C
599	CBR600F	11-12	HA-5907				KN-204*	*Chrome=KN-204C
599	CBR600RR	03-06	HA-6003				KN-204*	*Chrome=KN-204C
599	CBR600RR	07-16	HA-6007				KN-204*	*Chrome=KN-204C
599	CBR600RR	07-16	HA-6007R*				KN-204**	*Race Specific/ **Chrome=KN-204C
599	CBR600RR ABS	09-10	HA-6007				KN-204*	*Chrome=KN-204C
599	CBR600RR ABS	09-10	HA-6007R*				KN-204**	*Race Specific/ **Chrome=KN-204C
599	CBR600RR ABS	14-16	HA-6007				KN-204*	*Chrome=KN-204C
599	CBR600RR ABS	14-16	HA-6007R*				KN-204**	*Race Specific/ **Chrome=KN-204C
600	CB600 Hornet	98-03	HA-6098				KN-303*	*Chrome=KN-303C
600	CB600 Hornet	04-06	HA-6098				KN-204*	*Chrome=KN-204C
600	CB600 Hornet	08-11					KN-204*	*Chrome=KN-204C
600	CB600F	04-06					KN-204*	*Chrome=KN-204C
600	CB600F Hornet	03-06					KN-204*	*Chrome=KN-204C
600	CB600S Hornet	00-02					KN-303*	*Chrome=KN-303C
600	CB600S Hornet	03					KN-204*	*Chrome=KN-204C
600	CBF600F	05	HA-6098					
600	CBR600 Hurricane	91-94					KN-303*	*Chrome=KN-303C
600	CBR600 RA	09-10	HA-6007				KN-204*	*Chrome=KN-204C
600	CBR600 RA	09-10	HA-6007R*				KN-204**	*Race Specific/ **Chrome=KN-204C
600	CBR600 Sport	01-02					KN-204*	*Chrome=KN-204C
600	CBR600F	90	HA-6087				KN-303*	*Chrome=KN-303C
600	CBR600F	01-06	HA-6001				KN-204*	*Chrome=KN-204C
600	CBR600F	07					KN-204*	*Chrome=KN-204C

2) Requires Two; 3) Requires Three; 4) Requires Four. The use of custom air filter requires removal of air box. Some custom filters and intakes are not legal for sale or use on any pollution controlled motor vehicle in California or states adopting California emission procedures. See knfilters.com for CARB status on each part for a specific vehicle.

Motorcycle - Application Listing



CC	Model	Year	Air Filter	Air Filter Precharger	Custom	Custom Precharger	Oil Filter	Comments
HONDA								
600	CBR600F Hurricane	87-89	HA-6087				KN-303*	*Chrome=KN-303C
600	CBR600F2	91-94	HA-6091				KN-303*	*Chrome=KN-303C
600	CBR600F3	95-98	HA-6095				KN-303*	*Chrome=KN-303C
600	CBR600F4	99-00	HA-6099				KN-303*	*Chrome=KN-303C
600	CBR600F4i	01-06	HA-6001				KN-204*	*Chrome=KN-204C
600	NTV600	88-92					KN-303*	*Chrome=KN-303C
600	VT600C Shadow VLX	88-98	HA-6088				KN-303*	*Chrome=KN-303C
600	VT600C Shadow VLX	99-07	HA-6199				KN-303*	*Chrome=KN-303C
600	VT600CD Shadow VLX Deluxe	93-98	HA-6088				KN-303*	*Chrome=KN-303C
600	VT600CD Shadow VLX Deluxe	99-07	HA-6199				KN-303*	*Chrome=KN-303C
600	XL600L	83-87					KN-112	
600	XL600R	83-88					KN-112	
600	XL600V Transalp	87-89	HA-6089				KN-303*	*Chrome=KN-303C
600	XR600R	85-00	HA-1315	HA-1315PR			KN-112	
600	XR600R	01-02					KN-112	
647	NT650V Deauville	98-04					KN-303*	*Chrome=KN-303C
647	NTV650	90-91					KN-303*	*Chrome=KN-303C
647	NTV650 Revere	93-97					KN-303*	*Chrome=KN-303C
649	CB650F	14-16	HA-6414				KN-204*	*Chrome=KN-204C
649	CBR650F	14-16	HA-6414				KN-204*	*Chrome=KN-204C
649	CBR650F ABS	14-16	HA-6414				KN-204*	*Chrome=KN-204C
650	CB650	79-80	HA-0750				KN-401	
650	CB650	81-82	HA-7580		RC-2362*		KN-401	*Inc. 2 Filters
650	CB650 F2	91					KN-303*	*Chrome=KN-303C
650	CB650 SC	83-84					KN-401	
650	CB650 SCC	82-84					KN-401	
650	CB650C	80	HA-7580		RC-2362*		KN-401	*Inc. 2 Filters, Exc. Mechanical Carbs
650	CB650C	81	HA-7580		RC-2362*		KN-401	*Inc. 2 Filters
650	CB650C	82					KN-401	
650	CB650SC Nighthawk	80-81					KN-401	
650	CB650SC Nighthawk	82	HA-7580				KN-401	
650	CB650SC Nighthawk	83-85	HA-5583				KN-401	
650	CX650 ED Eurosport	83-86					KN-111	
650	CX650C Custom	83					KN-111	
650	CX650T Turbo	83-86					KN-111	
650	FMX650	05-06	HA-6505				KN-112	
650	FMX650	07					KN-112	
650	FX650 Vigor	99-02					KN-112	
650	GL650 Silver Wing	83-86					KN-111	
650	GL650i Silver Wing Interstate	83	HA-0783				KN-111	
650	NT650 Bros	88-92					KN-303*	*Chrome=KN-303C
650	NT650 Hawk GT	88-92					KN-303*	*Chrome=KN-303C
650	NT650V Deauville	05					KN-303*	*Chrome=KN-303C
650	NTV650	88-89					KN-303*	*Chrome=KN-303C
650	NX650 Dominator	88-00	HA-0001				KN-112	
650	NX650 Dominator	01-02					KN-112	
650	SLR650	97-00					KN-112	
650	XL650V Transalp	00-06	HA-6501				KN-303*	*Chrome=KN-303C
650	XL650V Transalp	07	HA-6501				KN-204*	*Chrome=KN-204C
650	XR650L	93-09	HA-6592	HA-6592PR			KN-112	
650	XR650L	11					KN-112	
650	XR650L	12-16	HA-6592	HA-6592PR			KN-112	
650	XR650L	17	HA-6592	HA-6592PR			KN-112	
650	XR650R	00-07	HA-6500				KN-112	
650	XR650 Africa Twin	88-90					KN-303*	*Chrome=KN-303C;PD03

2) Requires Two; 3) Requires Three; 4) Requires Four. The use of custom air filter requires removal of air box. Some custom filters and intakes are not legal for sale or use on any pollution controlled motor vehicle in California or states adopting California emission procedures. See knfilters.com for CARB status on each part for a specific vehicle.



Motorcycle - Application Listing

CC	Model	Year	Air Filter	Air Filter Precharger	Custom	Custom Precharger	Oil Filter	Comments
HONDA								
670	CTX700	14-16	HA-7012				KN-204*	*Chrome=KN-204C
670	CTX700 DCT ABS	14-16	HA-7012				KN-204*	*Chrome=KN-204C
670	CTX700N	14-15	HA-7012				KN-204*	*Chrome=KN-204C
670	CTX700N	16	HA-7012					
670	CTX700N DCT ABS	14-15	HA-7012				KN-204*	*Chrome=KN-204C
670	CTX700N DCT ABS	16	HA-7012					
670	Integra	12-13	HA-7012				KN-204*	*Chrome=KN-204C
670	NC700J NM4	15-16	HA-7012				KN-204*	*Chrome=KN-204C
670	NC700S	12-13	HA-7012				KN-204*	*Chrome=KN-204C
670	NC700X	12-16	HA-7012				KN-204*	*Chrome=KN-204C
670	NC700X DCT ABS	12-16	HA-7012				KN-204*	*Chrome=KN-204C
680	NT700V Deauville	12	HA-7010				KN-204*	*Chrome=KN-204C
680	NT700V Deauville	13-14	HA-7010					
680	NT700V Deauville	15	HA-7010				KN-204*	*Chrome=KN-204C
680	NT700V Deauville	16	HA-7010					
700	CB700SC Nighthawk S	84-86	HA-7084				KN-202	
700	NSA700 DN-01	08-09	HA-6708				KN-204*	*Chrome=KN-204C
700	NSA700 DN-01	10	HA-6708					
700	NT700V Deauville	06-11	HA-7010				KN-204*	*Chrome=KN-204C
700	NT700VA	10-11	HA-7010				KN-204*	*Chrome=KN-204C
700	NT700VA	12					KN-204*	*Chrome=KN-204C
700	NT700VAA	10					KN-204*	*Chrome=KN-204C
700	NT700VAA	11	HA-7010				KN-204*	*Chrome=KN-204C
700	NT700VAA	12					KN-204*	*Chrome=KN-204C
700	VF700C Magna	84-86	HA-1210				KN-202	
700	VF700F Interceptor	84-85	HA-1245				KN-202	
700	VF700S Sabre	84-85					KN-202	
700	VFR700 Interceptor	88					KN-202	
700	VFR700F Interceptor	86	HA-7587				KN-202	
700	VFR700F Interceptor	87					KN-202	
700	VFR700F2 Interceptor	86-87	HA-7587				KN-202	
700	VT700C Shadow	84-85	HA-1326				KN-202	
700	VT700C Shadow	86-87					KN-202	
700	XL700V Transalp	08-10	HA-7008				KN-204*	*Chrome=KN-204C
700	XL700V Transalp	11-12					KN-204*	*Chrome=KN-204C
739	RVF750R - RC45	94-98					KN-303*	*Chrome=KN-303C
739	VF750C Magna	94-99	HA-7594				KN-303*	*Chrome=KN-303C
739	VFR750F Interceptor	90-97	HA-0003				KN-303*	*Chrome=KN-303C
739	VFR750F Interceptor	98					KN-303*	*Chrome=KN-303C
742	XRV750 Africa Twin	90-92	HA-6089				KN-303*	*Chrome=KN-303C
742	XRV750 Africa Twin	93-03	HA-0008				KN-303*	*Chrome=KN-303C
745	Integra	14-16	HA-7012					
745	NC750	12-13					KN-204*	*Chrome=KN-204C
745	NC750	15					KN-204*	*Chrome=KN-204C
745	NC750J NM4 Vultus	14	HA-7012					
745	NC750J NM4 Vultus	15-16	HA-7012				KN-204*	*Chrome=KN-204C
745	NC750S	14-16	HA-7012				KN-204*	*Chrome=KN-204C
745	NC750X	14-16	HA-7012				KN-204*	*Chrome=KN-204C
745	VT750 C2B Shadow Phantom	12-13	HA-7504				KN-204*	*Chrome=KN-204C
745	VT750 RS Shadow	12-13	HA-7504				KN-204*	*Chrome=KN-204C
745	VT750C Shadow Aero	06	HA-7504				KN-204*	*Chrome=KN-204C
745	VT750C Shadow Aero	12-16	HA-7504				KN-204*	*Chrome=KN-204C
745	VT750C2 Shadow Spirit	13-14	HA-7504				KN-204*	*Chrome=KN-204C
745	VT750C2 Shadow Spirit ABS	13-14	HA-7504				KN-204*	*Chrome=KN-204C
745	VT750C2B Shadow Phantom	14-15	HA-7504				KN-204*	*Chrome=KN-204C

2) Requires Two; 3) Requires Three; 4) Requires Four. The use of custom air filter requires removal of air box. Some custom filters and intakes are not legal for sale or use on any pollution controlled motor vehicle in California or states adopting California emission procedures. See knfilters.com for CARB status on each part for a specific vehicle.

Motorcycle - Application Listing



CC	Model	Year	Air Filter	Air Filter Precharger	Custom	Custom Precharger	Oil Filter	Comments
HONDA								
745	VT750C2B Shadow Phantom	16					KN-204*	*Chrome=KN-204C
745	VT750CA Shadow Aero ABS	14-15	HA-7504				KN-204*	*Chrome=KN-204C
745	VT750CA Shadow Aero ABS	16					KN-204*	*Chrome=KN-204C
747	VF700C Magna	87	HA-7598				KN-202	
747	VF750C Magna	88	HA-7598				KN-202	
750	CB750	69-74	HA-0100		RC-2314*	22-8028PK	KN-401	*Inc. 4 Filters
750	CB750	75-78					KN-401	
750	CB750 F	80-85					KN-401	
750	CB750 F2	92-00					KN-303*	*Chrome=KN-303C
750	CB750 Limited Edition	79	HA-1079		RC-0984*	RC-1820DK	KN-401	*Inc. 4 Filters
750	CB750 Nighthawk	91-03	HA-7591				KN-303*	*Chrome=KN-303C
750	CB750 Seven Fifty	01-02					KN-303*	*Chrome=KN-303C
750	CB750A Hondamatic	76	HA-0100				KN-401	
750	CB750A Hondamatic	77-78	HA-0100		RC-2314*	22-8028PK	KN-401	*Inc. 4 Filters
750	CB750C Custom	80-82	HA-1079		RC-0984*	RC-1820DK	KN-401	*Inc. 4 Filters
750	CB750F Super Sport	75	HA-0100				KN-401	
750	CB750F Super Sport	76-78	HA-0100		RC-2314*	22-8028PK	KN-401	*Inc. 4 Filters
750	CB750F Super Sport	79-82	HA-1079		RC-0984*	RC-1820DK	KN-401	*Inc. 4 Filters
750	CB750K Four	75	HA-0100				KN-401	
750	CB750K Four	76-78	HA-0100		RC-2314*	22-8028PK	KN-401	*Inc. 4 Filters
750	CB750K Four	79-82	HA-1079		RC-0984*	RC-1820DK	KN-401	*Inc. 4 Filters
750	CB750SC Nighthawk	82-83	HA-1079		RC-0984*	RC-1820DK	KN-401	*Inc. 4 Filters
750	CBX750	84-86	HA-7591				KN-202	
750	RC30	88-91					KN-303*	*Chrome=KN-303C
750	VF750	83-85					KN-202	
750	VF750C Magna	82-83	HA-1210				KN-202	
750	VF750C Magna	87	HA-7598				KN-202	
750	VF750C Magna	89					KN-202	
750	VF750C Magna	93					KN-303*	*Chrome=KN-303C
750	VF750C Magna	00-03	HA-7594				KN-303*	*Chrome=KN-303C
750	VF750C2 Magna Deluxe	97-00	HA-7594				KN-303*	*Chrome=KN-303C
750	VF750CD Magna Deluxe	95-96	HA-7594				KN-303*	*Chrome=KN-303C
750	VF750V V45 Interceptor	83-84	HA-1245				KN-202	
750	VF750S Sabre	82-83					KN-202	
750	VFR750F Interceptor	86	HA-7587				KN-202	
750	VFR750F Interceptor	87					KN-202	
750	VFR750F Interceptor	88-89	HA-7587				KN-303*	*Chrome=KN-303C
750	VFR750R	00					KN-303*	*Chrome=KN-303C
750	VFR750R - RC30	90					KN-303*	*Chrome=KN-303C
750	VT750 C2 Shadow	01	HA-7500				KN-303*	*Chrome=KN-303C
750	VT750 C2 Shadow	12	HA-7504				KN-204*	*Chrome=KN-204C
750	VT750 C2B Shadow Phantom	10-11	HA-7504				KN-204*	*Chrome=KN-204C
750	VT750 RS Shadow	10-11	HA-7504				KN-204*	*Chrome=KN-204C
750	VT750C Shadow	83	HA-1326		RC-0982*	RC-1820DK	KN-202	*Inc. 2 Filters
750	VT750C Shadow	97					KN-303*	*Chrome=KN-303C
750	VT750C Shadow	99-00					KN-303*	*Chrome=KN-303C
750	VT750C Shadow	01	HA-7500				KN-303*	*Chrome=KN-303C
750	VT750C Shadow	02					KN-303*	*Chrome=KN-303C
750	VT750C Shadow	08	HA-7504				KN-204*	*Chrome=KN-204C
750	VT750C Shadow	11	HA-7504				KN-204*	*Chrome=KN-204C
750	VT750C Shadow A.C.E.	98-00	HA-7500				KN-303*	*Chrome=KN-303C
750	VT750C Shadow Aero	04-05	HA-7504				KN-204*	*Chrome=KN-204C
750	VT750C Shadow Aero	07-09	HA-7504				KN-204*	*Chrome=KN-204C
750	VT750C2 Shadow Spirit	04					KN-204*	*Chrome=KN-204C
750	VT750C2 Shadow Spirit	05-09	HA-7504				KN-204*	*Chrome=KN-204C

2) Requires Two; 3) Requires Three; 4) Requires Four. The use of custom air filter requires removal of air box. Some custom filters and intakes are not legal for sale or use on any pollution controlled motor vehicle in California or states adopting California emission procedures. See knfilters.com for CARB status on each part for a specific vehicle.



Motorcycle - Application Listing

CC	Model	Year	Air Filter	Air Filter Precharger	Custom	Custom Precharger	Oil Filter	Comments
HONDA								
750	VT750CD Shadow A.C.E. Deluxe	01-03	HA-7500				KN-303*	*Chrome=KN-303C
750	VT750CD Shadow Deluxe	98-00	HA-7500				KN-303*	*Chrome=KN-303C
750	VT750DC Shadow Spirit	01-03	HA-7500				KN-303*	*Chrome=KN-303C
750	VT750DC Shadow Spirit	04					KN-303*	*Chrome=KN-303C
750	VT750DC Shadow Spirit	05-07	HA-7500				KN-303*	*Chrome=KN-303C
782	VFR800 Crossrunner	11-12	HA-8098				KN-204*	*Chrome=KN-204C
782	VFR800 Crossrunner	13-14	HA-8098					
782	VFR800 Crossrunner	15	HA-8098				KN-204*	*Chrome=KN-204C
782	VFR800 Interceptor	98-01	HA-8098				KN-303*	*Chrome=KN-303C
782	VFR800 Interceptor	02-09	HA-8098				KN-204*	*Chrome=KN-204C
782	VFR800 Interceptor	14-15	HA-8098				KN-204*	*Chrome=KN-204C
782	VFR800A Interceptor ABS	02-09	HA-8098				KN-204*	*Chrome=KN-204C
782	VFR800D Interceptor DLX	14-15	HA-8098				KN-204*	*Chrome=KN-204C
792	PC800 Pacific Coast	90	HA-8089				KN-303*	*Chrome=KN-303C
800	PC800 Pacific Coast	89	HA-8089				KN-303*	*Chrome=KN-303C
800	PC800 Pacific Coast	94-98	HA-8089				KN-303*	*Chrome=KN-303C
800	VT800C Shadow	88					KN-202	
896	CBR900RR	92					KN-303*	*Chrome=KN-303C
900	CB900C	80-82	HA-1079		RC-0984*	RC-1820DK	KN-401	*Inc. 4 Filters
900	CB900F	79-80					KN-401	
900	CB900F	81-82	HA-1079		RC-0984*	RC-1820DK	KN-401	*Inc. 4 Filters
900	CB900F	84					KN-401	
900	CB900F Hornet	83					KN-401	
900	CBR900RR	93-99	HA-9092-A				KN-303*	*Chrome=KN-303C
900	CBR900RR Fireblade	00-01	HA-9200				KN-303*	*Chrome=KN-303C
900	CBR900RR Fireblade	02	HA-9502				KN-303*	*Chrome=KN-303C
900	CBR900RR Fireblade	03	HA-9502				KN-204*	*Chrome=KN-204C
919	919	02-07	HA-9002				KN-204*	*Chrome=KN-204C
919	CB900F	02-05	HA-9002				KN-204*	*Chrome=KN-204C
919	CB900F	06					KN-204*	*Chrome=KN-204C
919	CB900F	07	HA-9002				KN-204*	*Chrome=KN-204C
929	CBR929RR	00-01	HA-9200				KN-204*	*Chrome=KN-204C
954	CBR954RR	02-03	HA-9502				KN-204*	*Chrome=KN-204C
990	CBF1000	06-09	HA-1006				KN-204*	*Chrome=KN-204C
990	RC51	00-05	HA-5100				KN-204*	*Chrome=KN-204C
998	CB1000R	08-16	HA-1009				KN-204*	*Chrome=KN-204C
998	CRF1000L Africa Twin	16					KN-204*	*Chrome=KN-204C
998	CRF1000L Africa Twin ABS	16					KN-204*	*Chrome=KN-204C
998	CRF1000L Africa Twin DCT	16					KN-204*	*Chrome=KN-204C
999	CBR1000RR	04-07	HA-1004				KN-204*	*Chrome=KN-204C
999	CBR1000RR	04-07	HA-1004R*				KN-204**	*Race Specific/ **Chrome=KN-204C
999	CBR1000RR	08-16	HA-1008				KN-204*	*Chrome=KN-204C
999	CBR1000RR	08-16	HA-1008R*				KN-204**	*Race Specific/ **Chrome=KN-204C
999	CBR1000RR ABS	12-15	HA-1008				KN-204*	*Chrome=KN-204C
999	CBR1000RR ABS	12-15	HA-1008R*				KN-204**	*Race Specific/ **Chrome=KN-204C
999	CBR1000RR SP	14	HA-1008				KN-204*	*Chrome=KN-204C
999	CBR1000RR SP	14	HA-1008R*				KN-204**	*Race Specific/ **Chrome=KN-204C
999	CBR1000RR SP Repsol Edition	15-16	HA-1008				KN-204*	*Chrome=KN-204C
999	CBR1000RR SP Repsol Edition	15-16	HA-1008R*				KN-204**	*Race Specific/ **Chrome=KN-204C
1000	CB1000C	83	HA-1079		RC-0984*	RC-1820DK	KN-401	*Inc. 4 Filters
1000	CBF1000	10	HA-1006				KN-204*	*Chrome=KN-204C
1000	CBF1000	11					KN-204*	*Chrome=KN-204C

2) Requires Two; 3) Requires Three; 4) Requires Four. The use of custom air filter requires removal of air box. Some custom filters and intakes are not legal for sale or use on any pollution controlled motor vehicle in California or states adopting California emission procedures. See knfilters.com for CARB status on each part for a specific vehicle.

Motorcycle - Application Listing



CC	Model	Year	Air Filter	Air Filter Precharger	Custom	Custom Precharger	Oil Filter	Comments
HONDA								
1000	CBF1000 F	06-09					KN-204*	*Chrome=KN-204C
1000	CBF1000 F	10-13	HA-1009				KN-204*	*Chrome=KN-204C
1000	CBF1000 F	14	HA-1009					
1000	CBF1000 F	15-16	HA-1009				KN-204*	*Chrome=KN-204C
1000	CBF1000 F Ltd. Ed.	09					KN-204*	*Chrome=KN-204C
1000	CBF1000 F Travel	07-09					KN-204*	*Chrome=KN-204C
1000	CBF1000 F Travel	10	HA-1009				KN-204*	*Chrome=KN-204C
1000	CBR1000F	89	HA-1087				KN-303*	*Chrome=KN-303C
1000	CBX1000 ProLink	80-82					KN-401	
1000	CBX1000 ZA	78					KN-401	
1000	GL1000 Gold Wing	75-79	HA-0800				KN-401	
1000	GL1000 Gold Wing	80					KN-401	
1000	RC51	06	HA-5100				KN-204*	*Chrome=KN-204C
1000	VF1000F	85-86	HA-1250				KN-202	
1000	VF1000F Interceptor	84	HA-1250				KN-202	
1000	VF1000F Interceptor	85					KN-202	
1000	VF1000R	84					KN-202	
1000	VF1000R	85-86	HA-1250				KN-202	
1000	VTR1000 Firestorm	97-03	HA-0011				KN-303*	*Chrome=KN-303C
1000	VTR1000 Firestorm	04-05	HA-0011				KN-204*	*Chrome=KN-204C
1000	VTR1000 SP-1	00	HA-5100				KN-303*	*Chrome=KN-303C
1000	VTR1000 SP-1	01-02	HA-5100				KN-204*	*Chrome=KN-204C
1000	VTR1000 SP-2	02-06	HA-5100				KN-204*	*Chrome=KN-204C
1000	VTR1000 Super Hawk	97-05	HA-0011				KN-204*	*Chrome=KN-204C
1000	XL1000 Varadero	99-02	HA-0011				KN-303*	*Chrome=KN-303C
1000	XL1000 Varadero	03-10	HA-1003				KN-204*	*Chrome=KN-204C
1000	XL1000 Varadero	11					KN-204*	*Chrome=KN-204C
1006	CB1000 Big One	93-97	HA-1013-1				KN-303*	*Chrome=KN-303C
1006	CBR1000F	90-97	HA-1087				KN-303*	*Chrome=KN-303C
1006	CBR1000F	98-99					KN-303*	*Chrome=KN-303C
1047	CBX1000	79-82	HA-0900				KN-401	
1050	CBX1000	78	HA-0900				KN-401	
1062	CBR1000F	87-88	HA-1087				KN-303*	*Chrome=KN-303C
1062	VF1100C V65 Magna	84-85	HA-6583				KN-202	
1062	VF1100S Sabre	84-85					KN-202	
1100	CB1100 SF X-Eleven	02-03					KN-303*	*Chrome=KN-303C
1100	CB1100F	83	HA-1079		RC-0984*	RC-1820DK	KN-401	*Inc. 4 Filters
1100	CB1100R	81-83					KN-401	
1100	CB1100SF	99-01	HA-1199				KN-303*	*Chrome=KN-303C
1100	CBR1100XX Super Blackbird	96-98	HA-1197				KN-303*	*Chrome=KN-303C
1100	CBR1100XX Super Blackbird	99-06	HA-1199				KN-303*	*Chrome=KN-303C
1100	CBR1100XX Super Blackbird	07	HA-1199					
1100	GL1100 A Aspencade	82-83					KN-401	
1100	GL1100 Gold Wing	80-83	HA-8080				KN-401	
1100	GL1100 Gold Wing	84-85					KN-401	
1100	ST1100	91-02	HA-1191				KN-303*	*Chrome=KN-303C
1100	ST1100	03					KN-303*	*Chrome=KN-303C
1100	ST1100 A	90-95					KN-303*	*Chrome=KN-303C
1100	ST1100 ABS II	92-97					KN-303*	*Chrome=KN-303C
1100	ST1100 ABS II	98-01	HA-1191				KN-303*	*Chrome=KN-303C
1100	ST1100 Pan European	90-00					KN-303*	*Chrome=KN-303C
1100	VF1100	83-84					KN-202	
1100	VF1100C V65 Magna	82					KN-202	
1100	VF1100C V65 Magna	83	HA-6583				KN-202	
1100	VF1100C V65 Magna	86	HA-6583				KN-202	

2) Requires Two; 3) Requires Three; 4) Requires Four. The use of custom air filter requires removal of air box. Some custom filters and intakes are not legal for sale or use on any pollution controlled motor vehicle in California or states adopting California emission procedures. See knfilters.com for CARB status on each part for a specific vehicle.



Motorcycle - Application Listing

CC	Model	Year	Air Filter	Air Filter Precharger	Custom	Custom Precharger	Oil Filter	Comments
HONDA								
1100	VT1100C Shadow	85-86					KN-202	
1100	VT1100C Shadow	87-88	HA-1187				KN-202	
1100	VT1100C Shadow	89-98	HA-1187				KN-303*	*Chrome=KN-303C
1100	VT1100C Shadow Spirit	97-07	HA-1187				KN-303*	*Chrome=KN-303C
1100	VT1100C2 Shadow A.C.E.	95-99	HA-1187				KN-303*	*Chrome=KN-303C
1100	VT1100C2 Shadow Sabre	99					KN-303*	*Chrome=KN-303C
1100	VT1100C2 Shadow Sabre	00-07	HA-1187				KN-303*	*Chrome=KN-303C
1100	VT1100C3 Shadow Aero	98-02	HA-1187				KN-303*	*Chrome=KN-303C
1100	VT1100CL Shadow	92-94	HA-1187				KN-303*	*Chrome=KN-303C
1100	VT1100D2 Shadow A.C.E.	99	HA-1187				KN-303*	*Chrome=KN-303C
1100	VT1100T Shadow A.C.E. Tourer	98-01	HA-1187				KN-303*	*Chrome=KN-303C
1100	VT1100T Shadow A.C.E. Tourer	02					KN-303*	*Chrome=KN-303C
1100	X-11	99	HA-1199				KN-303*	*Chrome=KN-303C
1137	X-11	00-01	HA-1199				KN-303*	*Chrome=KN-303C
1140	CB1100	13-16	HA-1301				KN-204*	*Chrome=KN-204C
1140	CB1100 ABS	13-14	HA-1301				KN-204*	*Chrome=KN-204C
1140	CB1100 DLX	14	HA-1301				KN-204*	*Chrome=KN-204C
1200	GL1200	85-88					KN-401	
1200	GL1200 Gold Wing	84	HA-8084				KN-401	
1200	GL1200 Gold Wing	85-87					KN-401	
1200	GL1200 Gold Wing	90					KN-401	
1200	GL1200 Gold Wing SE-i	86	HA-8085				KN-401	
1200	GL1200A Gold Wing Aspencade	84-87	HA-8084				KN-401	
1200	GL1200i Gold Wing Interstate	84-87	HA-8084				KN-401	
1200	GL1200L Gold Wing Limited Edition	85	HA-8085				KN-401	
1237	VFR1200	14	HA-1110					
1237	VFR1200	15-16	HA-1110				KN-204*	*Chrome=KN-204C
1237	VFR1200 Crosstourer	12-13	HA-1110				KN-204*	*Chrome=KN-204C
1237	VFR1200 Crosstourer	14	HA-1110					
1237	VFR1200 Crosstourer	15-16	HA-1110				KN-204*	*Chrome=KN-204C
1237	VFR1200F	10-13	HA-1110				KN-204*	*Chrome=KN-204C
1237	VFR1200F	14	HA-1110					
1237	VFR1200F	15-16	HA-1110				KN-204*	*Chrome=KN-204C
1237	VFR1200F DCT	10	HA-1110				KN-204*	*Chrome=KN-204C
1237	VFR1200F DCT	12-13	HA-1110				KN-204*	*Chrome=KN-204C
1237	VFR1200X	16					KN-204*	*Chrome=KN-204C
1237	VFR1200X DCT	16					KN-204*	*Chrome=KN-204C
1261	CTX1300	14-16	HA-1302				KN-204*	*Chrome=KN-204C
1261	CTX1300 Deluxe	14	HA-1302				KN-204*	*Chrome=KN-204C
1261	ST1300	10-16	HA-1302				KN-204*	*Chrome=KN-204C
1261	ST1300 ABS	10	HA-1302				KN-204*	*Chrome=KN-204C
1261	STX1300	15					KN-204*	*Chrome=KN-204C
1284	VTX1300 Retro	04	HA-1330				KN-204*	*Chrome=KN-204C
1284	VTX1300C	04-05	HA-1330				KN-204*	*Chrome=KN-204C
1284	VTX1300R	05	HA-1330				KN-204*	*Chrome=KN-204C
1284	VTX1300S	03-05	HA-1330				KN-204*	*Chrome=KN-204C
1300	CB1300	06-07	HA-1301				KN-204*	*Chrome=KN-204C
1300	CB1300	09	HA-1301					
1300	CB1300	10-12	HA-1301				KN-204*	*Chrome=KN-204C
1300	CB1300 Super Four	01-02	HA-1301					
1300	CB1300 Super Four	03-05	HA-1301				KN-204*	*Chrome=KN-204C
1300	CB1300F	03-08					KN-204*	*Chrome=KN-204C
1300	CB1300S	06					KN-204*	*Chrome=KN-204C
1300	CB1300S	07-12	HA-1301				KN-204*	*Chrome=KN-204C
1300	CB1300SA	08-10					KN-204*	*Chrome=KN-204C

2) Requires Two; 3) Requires Three; 4) Requires Four. The use of custom air filter requires removal of air box. Some custom filters and intakes are not legal for sale or use on any pollution controlled motor vehicle in California or states adopting California emission procedures. See knfilters.com for CARB status on each part for a specific vehicle.

Motorcycle - Application Listing



CC	Model	Year	Air Filter	Air Filter Precharger	Custom	Custom Precharger	Oil Filter	Comments
HONDA								
1300	ST1300	02-09	HA-1302				KN-204*	*Chrome=KN-204C
1300	ST1300 Pan European	02-07	HA-1302				KN-204*	*Chrome=KN-204C
1300	ST1300 Pan European	08-09					KN-204*	*Chrome=KN-204C
1300	VTX1300C	06-09	HA-1330				KN-204*	*Chrome=KN-204C
1300	VTX1300R	06-09	HA-1330				KN-204*	*Chrome=KN-204C
1300	VTX1300S	06-07	HA-1330				KN-204*	*Chrome=KN-204C
1300	VTX1300T	08-09	HA-1330				KN-204*	*Chrome=KN-204C
1312	VT1300CR Stataline	10-16	HA-1310				KN-204*	*Chrome=KN-204C
1312	VT1300CRA Stataline ABS	14-16	HA-1310				KN-204*	*Chrome=KN-204C
1312	VT1300CS Sabre	10-14	HA-1310				KN-204*	*Chrome=KN-204C
1312	VT1300CS Sabre	15					KN-204*	*Chrome=KN-204C
1312	VT1300CSA Sabre ABS	14	HA-1310				KN-204*	*Chrome=KN-204C
1312	VT1300CT Interstate	10-15	HA-1310				KN-204*	*Chrome=KN-204C
1312	VT1300CTA Interstate ABS	14-15	HA-1310				KN-204*	*Chrome=KN-204C
1312	VT1300CX Fury	10-13	HA-1310				KN-204*	*Chrome=KN-204C
1312	VT1300CX Fury	15-16	HA-1310				KN-204*	*Chrome=KN-204C
1312	VT13CX Fury	14	HA-1310				KN-204*	*Chrome=KN-204C
1312	VT13CXA Fury ABS	14	HA-1310				KN-204*	*Chrome=KN-204C
1312	VT13CXA Fury ABS	15					KN-204*	*Chrome=KN-204C
1312	VT13CXA Fury ABS	16	HA-1310				KN-204*	*Chrome=KN-204C
1500	GL1500 Black Widow	01					KN-303*	*Chrome=KN-303C
1500	GL1500 Gold Wing	91-93					KN-303*	*Chrome=KN-303C
1500	GL1500C Valkyrie	03	HA-1596				KN-303*	*Chrome=KN-303C
1500	GL1500SE Gold Wing SE	01					KN-303*	*Chrome=KN-303C
1520	GL1500 Gold Wing	88-90	HA-8088				KN-303*	*Chrome=KN-303C
1520	GL1500 Valkyrie Interstate	99-01	HA-1596				KN-303*	*Chrome=KN-303C
1520	GL1500A Gold Wing Aspencade	91-00	HA-8088				KN-303*	*Chrome=KN-303C
1520	GL1500C Valkyrie	97-02	HA-1596				KN-303*	*Chrome=KN-303C
1520	GL1500CT Valkyrie Tourer	97-00	HA-1596				KN-303*	*Chrome=KN-303C
1520	GL1500i Gold Wing Interstate	91-96	HA-8088				KN-303*	*Chrome=KN-303C
1520	GL1500SE Gold Wing SE	90-00	HA-8088				KN-303*	*Chrome=KN-303C
1795	VTX1800 Retro	02-04	HA-1802				KN-204*	*Chrome=KN-204C
1795	VTX1800C	02-08	HA-1802		RK-3906*	E-3016DK	KN-204**	*Mirrored/ **Chrome=KN-204C
1795	VTX1800C	02-08	HA-1802		RK-3916*	E-3016DK	KN-204**	*Grooved/ **Chrome=KN-204C
1795	VTX1800C	02-08	HA-1802		RK-3926*	E-3016DK	KN-204**	*Flamed/ **Chrome=KN-204C
1795	VTX1800F	07-08	HA-1802		RK-3906*	E-3016DK	KN-204**	*Mirrored/ **Chrome=KN-204C
1795	VTX1800F	07-08	HA-1802		RK-3916*	E-3016DK	KN-204**	*Grooved/ **Chrome=KN-204C
1795	VTX1800F	07-08	HA-1802		RK-3926*	E-3016DK	KN-204**	*Flamed/ **Chrome=KN-204C
1795	VTX1800N	07-08	HA-1802		RK-3906*	E-3016DK	KN-204**	*Mirrored/ **Chrome=KN-204C
1795	VTX1800N	07-08	HA-1802		RK-3916*	E-3016DK	KN-204**	*Grooved/ **Chrome=KN-204C
1795	VTX1800N	07-08	HA-1802		RK-3926*	E-3016DK	KN-204**	*Flamed/ **Chrome=KN-204C
1795	VTX1800R	02-03	HA-1802				KN-204*	*Chrome=KN-204C
1795	VTX1800R	07	HA-1802		RK-3906*	E-3016DK	KN-204**	*Mirrored/ **Chrome=KN-204C
1795	VTX1800R	07	HA-1802		RK-3916*	E-3016DK	KN-204**	*Grooved/ **Chrome=KN-204C
1795	VTX1800R	07	HA-1802		RK-3926*	E-3016DK	KN-204**	*Flamed/ **Chrome=KN-204C
1795	VTX1800R	08					KN-204*	*Chrome=KN-204C
1795	VTX1800T	07-08	HA-1802		RK-3906*	E-3016DK	KN-204**	*Mirrored/ **Chrome=KN-204C
1795	VTX1800T	07-08	HA-1802		RK-3916*	E-3016DK	KN-204**	*Grooved/ **Chrome=KN-204C
1795	VTX1800T	07-08	HA-1802		RK-3926*	E-3016DK	KN-204**	*Flamed/ **Chrome=KN-204C
1800	GL1800 Gold Wing	01-05	HA-1801				KN-204*	*Chrome=KN-204C
1800	GL1800 Gold Wing Airbag	07-09	HA-1801				KN-204*	*Chrome=KN-204C
1800	GL1800A Gold Wing ABS	01-05	HA-1801				KN-204*	*Chrome=KN-204C
1800	GL1800HP Gold Wing AC	06	HA-1801				KN-204*	*Chrome=KN-204C
1800	GL1800HP Gold Wing AC	09	HA-1801				KN-204*	*Chrome=KN-204C
1800	GL1800HPN Gold Wing ACN	06-09	HA-1801				KN-204*	*Chrome=KN-204C

2) Requires Two; 3) Requires Three; 4) Requires Four. The use of custom air filter requires removal of air box. Some custom filters and intakes are not legal for sale or use on any pollution controlled motor vehicle in California or states adopting California emission procedures. See knfilters.com for CARB status on each part for a specific vehicle.



Motorcycle - Application Listing

CC	Model	Year	Air Filter	Air Filter Precharger	Custom	Custom Precharger	Oil Filter	Comments
HONDA								
1800	GL1800HPNA Gold Wing ACN ABS	06-09	HA-1801				KN-204*	*Chrome=KN-204C
1800	GL1800P Gold Wing PA	06-08	HA-1801				KN-204*	*Chrome=KN-204C
1800	VTX1800F	05-06	HA-1802				KN-204*	*Chrome=KN-204C
1800	VTX1800N	04-06	HA-1802				KN-204*	*Chrome=KN-204C
1800	VTX1800R	04-06	HA-1802				KN-204*	*Chrome=KN-204C
1800	VTX1800S	02-06	HA-1802				KN-204*	*Chrome=KN-204C
1832	GL1800 Gold Wing Airbag	10	HA-1801				KN-204*	*Chrome=KN-204C
1832	GL1800 Gold Wing Airbag	12-16	HA-1801				KN-204*	*Chrome=KN-204C
1832	GL1800 Valkyrie	14-15	HA-1801				KN-204*	*Chrome=KN-204C
1832	GL1800 Valkyrie ABS	14	HA-1801				KN-204*	*Chrome=KN-204C
1832	GL1800A Gold Wing ABS	10	HA-1801				KN-204*	*Chrome=KN-204C
1832	GL1800A Gold Wing ABS	12	HA-1801				KN-204*	*Chrome=KN-204C
1832	GL1800B Gold Wing F6B	13-16	HA-1801				KN-204*	*Chrome=KN-204C
1832	GL1800B Gold Wing F6B Deluxe	13-16	HA-1801				KN-204*	*Chrome=KN-204C
1832	GL1800HP Gold Wing AC	10	HA-1801				KN-204*	*Chrome=KN-204C
1832	GL1800HP Gold Wing AC	12-16	HA-1801				KN-204*	*Chrome=KN-204C
1832	GL1800HPN Gold Wing ACN	10	HA-1801				KN-204*	*Chrome=KN-204C
1832	GL1800HPNA Gold Wing ACN ABS	10	HA-1801				KN-204*	*Chrome=KN-204C
1832	GL1800HPNA Gold Wing ACN ABS	12	HA-1801				KN-204*	*Chrome=KN-204C
1832	GL1800HPNM Gold Wing ACN XM	12-16	HA-1801				KN-204*	*Chrome=KN-204C
1832	GL1800HPNM Gold Wing ACN XM ABS	12-16	HA-1801				KN-204*	*Chrome=KN-204C
1832	NRX1800 Valkyrie Rune	04-05					KN-204*	*Chrome=KN-204C
HUSABERG								
250	FE250	13					KN-655	
250	FE250	14					KN-652	
350	FE350	14					KN-652	
390	FE390	10-12					KN-655	
450	FC450	04-06					KN-155	
450	FE450	09-14					KN-655	
450	FE450E	04-08					KN-155	
450	FS450E	04-08					KN-155	
450	FX450	10-11					KN-655	
501	FE501	13-14					KN-655	
550	FC550	04-06					KN-155	
550	FE550E	04-08					KN-155	
550	FS550	04-08					KN-155	
570	FE570	09-12					KN-655	
570	FS570	10-12					KN-655	
650	FE650E	04-08					KN-155	
650	FS650C	05-08					KN-155	
650	FS650E	04-08					KN-155	
HUSQVARNA								
85	TC85 17/14	14-16	KT-4511XD	KT-4511DK				
125	CR125	95-13	HU-1200					
125	SMS4	12					KN-140	
125	TC125	14-15	KT-4511XD	KT-4511DK				
125	TE125	12					KN-140	
125	TE125	15-16	KT-4511XD	KT-4511DK				
125	WR125	95-10	HU-1200					
125	WR125	12-13	HU-1200					
126	CR125	92-94	HU-1200					
126	WR125	92-94	HU-1200					
150	CR150	11	HU-1200					
249	TC250	14-16	KT-4511XD	KT-4511DK				
249	TE250	02					KN-154	

2) Requires Two; 3) Requires Three; 4) Requires Four. The use of custom air filter requires removal of air box. Some custom filters and intakes are not legal for sale or use on any pollution controlled motor vehicle in California or states adopting California emission procedures. See knfilters.com for CARB status on each part for a specific vehicle.

Motorcycle - Application Listing



CC	Model	Year	Air Filter	Air Filter Precharger	Custom	Custom Precharger	Oil Filter	Comments
HUSQVARNA								
249	TE250	03-07	HU-1200				KN-154	
249	TE250	08-09	HU-1200				KN-563	
249	TE250	10-13	HU-1200				KN-116	
249	TE250	14-16	KT-4511XD	KT-4511DK				
250	CR250	93-03	HU-1200					
250	FC250	14-16					KN-652	
250	FE250	14-15					KN-652	
250	FE250	16	KT-4511XD	KT-4511DK			KN-652	
250	SM250R	07					KN-154	
250	TC250	02					KN-154	
250	TC250	03-07	HU-1200				KN-154	
250	TC250	08	HU-1200				KN-563	
250	TC250	09-12	HU-1200				KN-116	
250	TC250R	13	HU-1200				KN-116	
250	TXC250	08-09	HU-1200				KN-563	
250	TXC250	10-12	HU-1200				KN-116	
250	TXC250R	13	HU-1200				KN-116	
250	WR250	92-10	HU-1200					
250	WR250	12-13	HU-1200					
293	TE300	14-16	KT-4511XD	KT-4511DK				
300	WR300	09-10	HU-1200					
300	WR300	12-13	HU-1200					
310	TE310	09					KN-563	
310	TE310	10	HU-1200				KN-563	
310	TE310	11-12	HU-1200				KN-116	
310	TE310R	13	HU-1200				KN-116	
310	TXC310	12	HU-1200					
310	TXC310R	13	HU-1200				KN-116	
349	WR360	92-94	HU-1200					
350	FC350	15-16					KN-652	
350	FE350	14-15					KN-652	
350	FE350	16	KT-4511XD	KT-4511DK			KN-652	
350	FE350S	16	KT-4511XD	KT-4511DK			KN-652	
360	WR360	95-03	HU-1200					
400	SM400R	04-05	HU-1200				KN-154	
410	TE410E	98-01					KN-154	
449	FE450	15					KN-655	
449	FE450	16	KT-4511XD	KT-4511DK			KN-655	
449	TC449	11-12					KN-611	
449	TE449	11-12					KN-611	
450	FC450	14-16					KN-655	
450	FS450	16					KN-652	
450	SM450R	03-07	HU-1200				KN-154	
450	SM450R	08-10	HU-1200				KN-563	
450	SM450RR	09					KN-563	
450	SMR450	10	HU-1200				KN-611	
450	TC450	02					KN-154	
450	TC450	03-07	HU-1200				KN-154	
450	TC450	08-10	HU-1200				KN-563	
450	TE450	02					KN-154	
450	TE450	03-07	HU-1200				KN-154	
450	TE450	08-10	HU-1200				KN-563	
450	TXC450	08-10	HU-1200				KN-563	
450	TXC450	11					KN-563	
510	FE501	14-16	KT-4511XD	KT-4511DK			KN-655	

2) Requires Two; 3) Requires Three; 4) Requires Four. The use of custom air filter requires removal of air box. Some custom filters and intakes are not legal for sale or use on any pollution controlled motor vehicle in California or states adopting California emission procedures. See knfilters.com for CARB status on each part for a specific vehicle.



Motorcycle - Application Listing

CC	Model	Year	Air Filter	Air Filter Precharger	Custom	Custom Precharger	Oil Filter	Comments
HUSQVARNA								
510	FE501S	16	KT-4511XD	KT-4511DK			KN-655	
510	SM510R	03-07	HU-1200				KN-154	
510	SM510R	08-09	HU-1200				KN-563	
510	SM510R	10					KN-563	
510	SMR510	10	HU-1200				KN-611	
510	TC510	86-87	HU-0600					
510	TC510	03-07	HU-1200				KN-154	
510	TC510	08-10	HU-1200				KN-563	
510	TCX510	08-11					KN-563	
510	TE510	86-87	HU-0600					
510	TE510	03-07	HU-1200				KN-154	
510	TE510	08-10	HU-1200				KN-563	
510	TXC510	08-10	HU-1200				KN-563	
510	TXC510	11					KN-563	
511	SMR511	11					KN-611	
511	TE511	11-12					KN-611	
530	SM530RR	09					KN-563	
610	SM610	98-99					KN-154	
610	SM610	06-08					KN-154	
610	SM610S	00-01					KN-154	
610	SM610S IE	06-08					KN-154	
610	TE610	06-08					KN-154	
610	TE610 IE	06-08					KN-154	
610	TE610E	98-01					KN-154	
610	TE610E LT	00					KN-154	
630	SM630 IE	10					KN-563	
630	SMR630	11					KN-563	
630	SMS630	11					KN-563	
630	TE630	11					KN-563	
690	701 Enduro	16					KN-155*	*Tall Filter
690	701 Enduro	16					KN-651*	*Short Filter
690	701 Supermoto	16					KN-155*	*Tall Filter
690	701 Supermoto	16					KN-651*	*Short Filter
898	Nuda 900	12	BM-8006				KN-160	
898	Nuda 900R	12	BM-8006				KN-160	
INDIAN								
1436	Chief	99-00	E-3971*					*w/S&S teardrop backplate & Indian teardrop cvr
1436	Scout	01-03	E-3971*					*w/S&S teardrop backplate & Indian teardrop cvr
1436	Spirit	01-03	E-3971*					*w/S&S teardrop backplate & Indian teardrop cvr
1638	Chief	02-03	E-3981					
69 CI	Scout	15-16	PL-1115					
69 CI	Scout Sixty	16	PL-1115					
111 CI	Chief Classic	14	PL-1814					
111 CI	Chief Classic	15	PL-1814				KN-157	
111 CI	Chief Classic	16	PL-1814				KN-175	
111 CI	Chief Classic	17	PL-1814					
111 CI	Chief Dark Horse	16	PL-1814				KN-175	
111 CI	Chief Dark Horse	17	PL-1814					
111 CI	Chief Vintage	14	PL-1814					
111 CI	Chief Vintage	15	PL-1814				KN-157	
111 CI	Chief Vintage	16	PL-1814				KN-175	
111 CI	Chief Vintage	17	PL-1814					
111 CI	Chieftain	14	PL-1814					

2) Requires Two; 3) Requires Three; 4) Requires Four. The use of custom air filter requires removal of air box. Some custom filters and intakes are not legal for sale or use on any pollution controlled motor vehicle in California or states adopting California emission procedures. See knfilters.com for CARB status on each part for a specific vehicle.

Motorcycle - Application Listing



CC	Model	Year	Air Filter	Air Filter Precharger	Custom	Custom Precharger	Oil Filter	Comments
INDIAN								
111	CI Chieftain	15	PL-1814				KN-157	
111	CI Chieftain	16	PL-1814				KN-175	
111	CI Chieftain	17	PL-1814					
111	CI Chieftain Dark Horse	16	PL-1814				KN-175	
111	CI Chieftain Dark Horse	17	PL-1814					
111	CI Roadmaster	15	PL-1814				KN-157	
111	CI Roadmaster	16	PL-1814				KN-175	
111	CI Roadmaster	17	PL-1814					
111	CI Springfield	16-17	PL-1814					
KAWASAKI								
60	KX60	85-03	KA-6085					
65	KX65	00-09	KA-8088	22-8088PK				
65	KX65	11-17	KA-8088	22-8088PK				
75	KV75	76-80			RU-0060	22-8008PK		
80	KX80	79-80			R-1030	22-8010PK		
80	KX80	91-00	KA-8088	22-8088PK				
80	KX80 Big Wheel	91-94	KA-8088	22-8088PK				
85	KX85	01-13	KA-8088	22-8088PK				
99	KX100	95-09	KA-8088	22-8088PK				
99	KX100	11-13	KA-8088	22-8088PK				
110	KLX110	02-16	KA-1102				KN-112	
110	KLX110	17	KA-1102					
110	KLX110L	14-16	KA-1102				KN-112	
110	KLX110L	17	KA-1102					
110	KSR110	02					KN-112	
110	KSR110	03-08	KA-1102				KN-112	
110	KSR110	09-11					KN-112	
125	BN125 Eliminator	98-09					KN-112	
125	KLX125	03-06	KA-1203				KN-132	
125	KLX125	10-11					KN-112	
125	KLX125 D-Tracker	10-11					KN-112	
125	KLX125L	03-06	KA-1203				KN-132	
125	KX125	87-89	KA-1287					
125	KX125	97-05	KA-1297					
125	KX125	06-08	KA-1297*					*Non-US
144	KLX140	08-16	KA-1408				KN-112	
144	KLX140	17					KN-112	
144	KLX140G	17					KN-112	
144	KLX140L	08-16	KA-1408				KN-112	
144	KLX140L	17					KN-112	
200	KDX200	89-06	KA-1287					
200	Z200	77-83					KN-123	
220	KDX220R	97-05	KA-1287					
246	KDX250	91-94	KA-1287					
249	EL250 Eliminator	90-95					KN-401	
249	KX250F	12-16	KA-2506XD				KN-207	
249	KX250F	17					KN-207	
250	BJ250 Estrella	92-00					KN-123	
250	BJ250 Estrella	07-08					KN-123	
250	BJ250 Estrella Custom	96-06					KN-123	
250	BJ250 Estrella Custom Ltd. Edition	02					KN-123	
250	BJ250 Estrella RS	95					KN-123	
250	BJ250 Estrella RS	97-06					KN-123	
250	BJ250 Estrella RS Custom	96-99					KN-123	
250	BJ250 Estrella RS Ltd. Edition	02-06					KN-123	

2) Requires Two; 3) Requires Three; 4) Requires Four. The use of custom air filter requires removal of air box. Some custom filters and intakes are not legal for sale or use on any pollution controlled motor vehicle in California or states adopting California emission procedures. See knfilters.com for CARB status on each part for a specific vehicle.



Motorcycle - Application Listing

CC	Model	Year	Air Filter	Air Filter Precharger	Custom	Custom Precharger	Oil Filter	Comments
KAWASAKI								
250	BJ250 TR	02-08					KN-123	
250	EL250 Eliminator	88-89	KA-7587				KN-401	
250	EL250 Eliminator	96-03					KN-401	
250	EL250 Eliminator LX	89-90	KA-7587				KN-401	
250	EL250 Eliminator LX	93-94	KA-7587				KN-401	
250	EL250 Eliminator LX	96	KA-7587				KN-401	
250	EL250 Eliminator LX	98	KA-7587				KN-401	
250	EL250 Eliminator SE	88-90	KA-7587				KN-401	
250	EL250 Eliminator SE	94	KA-7587				KN-401	
250	EL250 Eliminator SE	96	KA-7587				KN-401	
250	EL252	96-02					KN-401	
250	EX250R Ninja	86-01	KA-2586		RC-1822*	RC-1820DK	KN-401	*Inc. 2 Filters
250	EX250R Ninja	02-07	KA-2586				KN-401	
250	EX250R Ninja	08-12	KA-2508				KN-401	
250	GPX250R	88					KN-401	
250	KL250	77					KN-123	
250	KL250	78-79			RU-1050	RU-0520PK	KN-123	
250	KL250	80-84			RU-0520	25-1770	KN-123	
250	KL250	80-84			RU-0520	RU-0520PK	KN-123	
250	KL250 Super Sherpa	97-98					KN-112	
250	KL250 Super Sherpa	00-07					KN-112	
250	KL250 Super Sherpa	09-10					KN-112	
250	KLR250	85-05					KN-123	
250	KLX250	79-80			RU-0520	25-1770		
250	KLX250	79-80			RU-0520	RU-0520PK		
250	KLX250	90-92					KN-112	
250	KLX250 D-Tracker	98-99	KA-1287				KN-112	
250	KLX250 D-Tracker	01-07	KA-1287				KN-112	
250	KLX250 D-Tracker X	08-09					KN-112	
250	KLX250R	91-93					KN-112	
250	KLX250R	94-96	KA-1287				KN-112	
250	KLX250R	97					KN-112	
250	KLX250S	06-07	KA-1287				KN-112	
250	KLX250S	09-10					KN-112	
250	KLX250S	12-14					KN-112	
250	KLX250SF	09-10					KN-112	
250	KX250	87-89	KA-1287					
250	KX250	97-05	KA-1297					
250	KX250	06-07	KA-1297				KN-207	
250	KX250	08	KA-1297*				KN-207	*Non-US
250	KX250F	04-05	KA-2504				KN-207	
250	KX250F	06-11	KA-2506XD				KN-207	
250	KZ250	80-83					KN-123	
250	VN250 Eliminator V	97-02					KN-303*	*Chrome=KN-303C
250	VN250 Eliminator V	04-06					KN-204*	*Chrome=KN-204C
250	VN250 Eliminator V	07					KN-303*	*Chrome=KN-303C
250	Z250 LTD	81-83					KN-123	
250	ZR250 Balius II	97-98					KN-204*	*Chrome=KN-204C
250	ZR250 Balius II	00-06					KN-204*	*Chrome=KN-204C
250	ZXR250	91-93					KN-303*	*Chrome=KN-303C
250	ZZR250	90-93					KN-401	
250	ZZR250	98-02					KN-401	
296	EX300 Ninja	13-16	KA-2508				KN-303*	*Chrome=KN-303C
296	EX300 Ninja ABS	13-16	KA-2508				KN-303*	*Chrome=KN-303C
296	EX300 Ninja ABS KRT Edition	16	KA-2508				KN-303*	*Chrome=KN-303C

2) Requires Two; 3) Requires Three; 4) Requires Four. The use of custom air filter requires removal of air box. Some custom filters and intakes are not legal for sale or use on any pollution controlled motor vehicle in California or states adopting California emission procedures. See knfilters.com for CARB status on each part for a specific vehicle.

Motorcycle - Application Listing



CC	Model	Year	Air Filter	Air Filter Precharger	Custom	Custom Precharger	Oil Filter	Comments
KAWASAKI								
296	EX300 Ninja ABS SE	14	KA-2508				KN-303*	*Chrome=KN-303C
296	EX300 Ninja SE	14-15	KA-2508				KN-303*	*Chrome=KN-303C
296	Z300	15-16	KA-2508					
300	KLX300R	96-07	KA-1287				KN-112	
300	KLX300R	08					KN-112	
398	KLX400R	03	SU-4000	SU-4000PK			KN-139	
398	KLX400SR	03	SU-4000	SU-4000PK			KN-139	
400	EX400	89-90					KN-202	
400	GPZ400R	85-86					KN-401	
400	GPZ400R	89	KA-0850				KN-401	
400	KH400	76-78			RC-1133*	RU-0150PK		*Inc. 3 Filters
400	KZ400 M1	83					KN-401	
400	KZ400A	77-78	KA-1200				KN-401	
400	KZ400B	78-79					KN-401	
400	KZ400C	78					KN-401	
400	KZ400D	74-75	KA-1150				KN-401	
400	KZ400D	76-77	KA-1200				KN-401	
400	KZ400H	79					KN-401	
400	KZ400J	80-83					KN-401	
400	KZ400S	75	KA-1150				KN-401	
400	KZ400S	76-77	KA-1200				KN-401	
400	VN400 Vulcan	95-98	KA-8095				KN-303*	*Chrome=KN-303C
400	W400	06-08					KN-303*	*Chrome=KN-303C
400	Z400	74-77					KN-401	
400	Z400 LTD	78-80					KN-401	
400	Z400F	83-85					KN-401	
400	Z400F2	84-87					KN-401	
400	ZL400 Eliminator	94-95					KN-401	
400	ZR400 Xanthus	92					KN-303*	*Chrome=KN-303C
400	ZR400 Xanthus	94-95					KN-303*	*Chrome=KN-303C
400	ZR400 Zephyr	89-95	KA-0850				KN-401	
400	ZR400 Zephyr X	96-98	KA-0850				KN-401	
400	ZR400 Zephyr X	00-02	KA-0850				KN-401	
400	ZR400 Zephyr X	03-08					KN-401	
400	ZRX400	94-96					KN-303*	*Chrome=KN-303C
400	ZRX400	98-01					KN-303*	*Chrome=KN-303C
400	ZRX400	03-08					KN-303*	*Chrome=KN-303C
400	ZX4	87-90					KN-303*	*Chrome=KN-303C
400	ZXR400	90	KA-4010					
400	ZXR400L	91-99	KA-4091				KN-303*	*Chrome=KN-303C
400	ZXR400L	00-02					KN-303*	*Chrome=KN-303C
400	ZXR400R	89-90					KN-303*	*Chrome=KN-303C
400	ZXR400R	91-94	KA-4091				KN-303*	*Chrome=KN-303C
400	ZXR400R	99	KA-4091				KN-303*	*Chrome=KN-303C
400	ZZR400	93-99	KA-6093				KN-303*	*Chrome=KN-303C
400	ZZR400	00					KN-303*	*Chrome=KN-303C
400	ZZR400	01	KA-6093				KN-303*	*Chrome=KN-303C
400	ZZR400	03-06	KA-6093				KN-303*	*Chrome=KN-303C
440	KZ440A	80-83					KN-401	
440	KZ440B	80-81					KN-401	
440	KZ440D	80-83					KN-401	
440	KZ440G	82					KN-401	
440	Z440	80-84					KN-401	
440	Z440 LTD	80-85					KN-401	
449	KX450F	12-15	KA-2506XD				KN-112	

2) Requires Two; 3) Requires Three; 4) Requires Four. The use of custom air filter requires removal of air box. Some custom filters and intakes are not legal for sale or use on any pollution controlled motor vehicle in California or states adopting California emission procedures. See knfilters.com for CARB status on each part for a specific vehicle.



Motorcycle - Application Listing

CC	Model	Year	Air Filter	Air Filter Precharger	Custom	Custom Precharger	Oil Filter	Comments
KAWASAKI								
449	KX450F	16-17					KN-207	
450	EN450	85-90					KN-202	
450	KLX450R	08-14	KA-4408	KA-4408DK			KN-112	
450	KX450F	06-11	KA-2506XD				KN-112	
500	EN500 Vulcan	90-96	KA-5090				KN-303*	*Chrome=KN-303C
500	EN500 Vulcan LTD	96-02	KA-5096				KN-303*	*Chrome=KN-303C
500	EN500 Vulcan LTD	03-06	KA-5096				KN-204*	*Chrome=KN-204C
500	EN500 Vulcan LTD	07-09	KA-5096				KN-303*	*Chrome=KN-303C
500	ER5	96					KN-303*	*Chrome=KN-303C
500	ER5	97-05	KA-0018				KN-303*	*Chrome=KN-303C
500	ER5	06					KN-303*	*Chrome=KN-303C
500	ER500 Twister	99					KN-303*	*Chrome=KN-303C
500	EX500	87-89	KA-5087		RC-0982*	RC-1820DK	KN-202	*Inc. 2 Filters
500	EX500	90-93	KA-5087		RC-0982*	RC-1820DK	KN-303**	*Inc. 2 Filters/ **Chrome=KN-303C
500	EX500 Ninja	94-96	KA-5087		RC-0982*	RC-1820DK	KN-303**	*Inc. 2 Filters/ **Chrome=KN-303C
500	EX500R Ninja	97-02	KA-5087		RC-0982*	RC-1820DK	KN-303**	*Inc. 2 Filters/ **Chrome=KN-303C
500	EX500R Ninja	03-04	KA-5087		RC-0982*	RC-1820DK	KN-204**	*Inc. 2 Filters/ **Chrome=KN-204C
500	EX500R Ninja	05-06	KA-5087				KN-204*	*Chrome=KN-204C
500	EX500R Ninja	07-09	KA-5087				KN-303*	*Chrome=KN-303C
500	GPZ500S	87-89					KN-202	
500	GPZ500S	90-01					KN-303*	*Chrome=KN-303C
500	GPZ500S	02	KA-5087				KN-204*	*Chrome=KN-204C
500	GPZ500S	03					KN-204*	*Chrome=KN-204C
500	H1 Mach III	69-75	KA-1000					
500	KLE500	91-07					KN-303*	*Chrome=KN-303C
500	KX500	87-04	KA-1287					
500	Z500	79-81					KN-401	
500	ZZR500	90-96					KN-303*	*Chrome=KN-303C
539	GT550	90-95					KN-401	
550	GPZ550	81					KN-401	
550	GT550	83-89					KN-401	
550	GT550	96-01					KN-401	
550	KZ550 LTD	84	KA-0850		RC-2382*		KN-401	*Inc. 2 Filters
550	KZ550 Spectre	83-84	KA-0850		RC-2382*		KN-401	*Inc. 2 Filters
550	KZ550A	80-81	KA-0850		RC-2294*	22-8028PK	KN-401	*Inc. 4 Filters
550	KZ550A	82-83	KA-0850				KN-401	
550	KZ550C LTD	80-81	KA-0850				KN-401	
550	KZ550C LTD	82-83	KA-0850		RC-2294*	22-8028PK	KN-401	*Inc. 4 Filters
550	KZ550D GP	81	KA-0850		RC-2294*	22-8028PK	KN-401	*Inc. 4 Filters
550	KZ550H GP	82-83	KA-1700		RC-1824*	RC-1820DK	KN-401	*Inc. 4 Filters
550	KZ550H GP	84					KN-401	
550	Z550	79-83					KN-401	
550	Z550 LTD	81-83					KN-401	
550	Z550F	80-83					KN-401	
550	ZR550 Zephyr	90-99	KA-0850				KN-401	
550	ZR550 Zephyr	00					KN-401	
550	ZX550 GPZ	82-83					KN-401	
550	ZX550 GPZ	84-85	KA-0850		RC-1824*	RC-1820DK	KN-401	*Inc. 4 Filters
550	ZX550 GPZ	86	KA-0850		RC-2382*		KN-401	*Inc. 2 Filters
550	ZX550 GPZ	87-92					KN-401	
560	KLR600	90	KA-0009				KN-123	
560	KLR600	91-93	KA-0009					
588	ZX6R Ninja	01	KA-6098				KN-303*	*Chrome=KN-303C

2) Requires Two; 3) Requires Three; 4) Requires Four. The use of custom air filter requires removal of air box. Some custom filters and intakes are not legal for sale or use on any pollution controlled motor vehicle in California or states adopting California emission procedures. See knfilters.com for CARB status on each part for a specific vehicle.

Motorcycle - Application Listing



CC	Model	Year	Air Filter	Air Filter Precharger	Custom	Custom Precharger	Oil Filter	Comments
KAWASAKI								
588	ZX6R Ninja	02	KA-6098				KN-204*	*Chrome=KN-204C
599	ZX600 Ninja	88-89	KA-7587		RC-1824*	RC-1820DK	KN-401	*Inc. 4 Filters
599	ZX600R Ninja	90-94	KA-7587		RC-1824*	RC-1820DK	KN-401	*Inc. 4 Filters
599	ZX6R Ninja	10-12	KA-6009				KN-303*	*Chrome=KN-303C
599	ZX6R Ninja	10-12	KA-6009R*				KN-303**	*Race Specific/ **Chrome=KN-303C
600	GPX600R	88-00					KN-401	
600	GPZ600R	85-89					KN-401	
600	KL600	84-90					KN-123	
600	KLR600	84-87					KN-123	
600	KLR600	88-89	KA-0009				KN-123	
600	ZL600	86-87			RC-1824*	RC-1820DK	KN-401	*Inc. 4 Filters
600	ZL600 Eliminator	95					KN-401	
600	ZL600 Eliminator	96-97			RC-1824*	RC-1820DK	KN-401	*Inc. 4 Filters
600	ZL600 Eliminator	98					KN-401	
600	ZX6 Ninja	90-92					KN-303*	*Chrome=KN-303C
600	ZX6 Ninja	93-01	KA-6093*				KN-303**	*Exc. OE Filter w/hole/ **Chrome=KN-303C
600	ZX600R Ninja	95-97	KA-7587		RC-1824*	RC-1820DK	KN-401	*Inc. 4 Filters
600	ZX6R Ninja	95-97	KA-6095				KN-303*	*Chrome=KN-303C
600	ZX6R Ninja	98-00	KA-6098				KN-303*	*Chrome=KN-303C
600	ZX6R Ninja	07-08	KA-6007				KN-303*	*Chrome=KN-303C
600	ZX6R Ninja	07-08	KA-6007R*				KN-303**	*Race Specific/ **Chrome=KN-303C
600	ZX6R Ninja	09	KA-6009				KN-303*	*Chrome=KN-303C
600	ZX6R Ninja	09	KA-6009R*				KN-303**	*Race Specific/ **Chrome=KN-303C
600	ZX6RR Ninja	03-04	KA-6003				KN-204*	*Chrome=KN-204C
600	ZX6RR Ninja	05-06	KA-6005				KN-204*	*Chrome=KN-204C
600	ZZR600	90-92					KN-303*	*Chrome=KN-303C
600	ZZR600	93-01	KA-6093*				KN-303**	*Exc. OE Filter w/hole/ **Chrome=KN-303C
600	ZZR600	02-04	KA-6093*				KN-204**	*Exc. OE Filter w/hole/ **Chrome=KN-204C
600	ZZR600	05-06	KA-6093*				KN-204**	*Non-US/ **Chrome=KN-204C
600	ZZR600	05-06	KA-6098*				KN-204**	*US/ **Chrome=KN-204C
600	ZZR600	07-08	KA-6098*				KN-303**	*US/ **Chrome=KN-303C;US
636	ZX636 Ninja ZX-6R	15					KN-303*	*Chrome=KN-303C
636	ZX636 Ninja ZX-6R ABS	15					KN-303*	*Chrome=KN-303C
636	ZX636 Ninja ZX-6R ABS KRT Edition	16					KN-303*	*Chrome=KN-303C
636	ZX6R Ninja	03-04	KA-6003				KN-303*	*Chrome=KN-303C
636	ZX6R Ninja	05	KA-6005				KN-303*	*Chrome=KN-303C
636	ZX6R Ninja	06	KA-6005				KN-204*	*Chrome=KN-204C
636	ZX6R Ninja	13-16	KA-6009				KN-303*	*Chrome=KN-303C
636	ZX6R Ninja	13-16	KA-6009R*				KN-303**	*Race Specific/ **Chrome=KN-303C
649	EN650 Vulcan S	15-16					KN-303*	*Chrome=KN-303C
649	EN650 Vulcan S ABS	15-16					KN-303*	*Chrome=KN-303C
649	EN650 Vulcan S ABS Cafe	16					KN-303*	*Chrome=KN-303C
649	EN650 Vulcan S ABS SE	16					KN-303*	*Chrome=KN-303C
649	ER6f	16	KA-6512				KN-303*	*Chrome=KN-303C
649	ER6n	16	KA-6512				KN-303*	*Chrome=KN-303C
649	EX650 Ninja	12-16	KA-6512				KN-303*	*Chrome=KN-303C
649	EX650 Ninja ABS	13-16	KA-6512				KN-303*	*Chrome=KN-303C
649	EX650R Ninja	06					KN-204*	*Chrome=KN-204C
649	EX650R Ninja	07-11					KN-303*	*Chrome=KN-303C
650	ER6f	06					KN-204*	*Chrome=KN-204C

2) Requires Two; 3) Requires Three; 4) Requires Four. The use of custom air filter requires removal of air box. Some custom filters and intakes are not legal for sale or use on any pollution controlled motor vehicle in California or states adopting California emission procedures. See knfilters.com for CARB status on each part for a specific vehicle.



Motorcycle - Application Listing

CC	Model	Year	Air Filter	Air Filter Precharger	Custom	Custom Precharger	Oil Filter	Comments
KAWASAKI								
650	ER6f	07-09					KN-303*	*Chrome=KN-303C
650	ER6f	12-14	KA-6512					
650	ER6f	15	KA-6512				KN-303*	*Chrome=KN-303C
650	ER6n	06					KN-204*	*Chrome=KN-204C
650	ER6n	07-11					KN-303*	*Chrome=KN-303C
650	ER6n	12-15	KA-6512				KN-303*	*Chrome=KN-303C
650	KL650 Tengai	89					KN-123	
650	KLE650 Versys	07-16					KN-303*	*Chrome=KN-303C
650	KLR650	87-16	KA-6589	KA-6589PL			KN-123	
650	KLR650 Camo	16	KA-6589	KA-6589PL			KN-123	
650	KLR650 New Edition	14	KA-6589	KA-6589PL			KN-123	
650	KLX650C	93-96	KA-6589	KA-6589PL			KN-123	
650	KLX650C	97					KN-123	
650	KLX650D	96	KA-1287				KN-123	
650	KLX650R	93-97	KA-1287				KN-123	
650	KLX650R	98-01					KN-123	
650	KR650 C1	93					KN-401	
650	KZ650B	77-79	KA-1200		RC-2314*	22-8028PK	KN-401	*Inc. 4 Filters
650	KZ650C Custom	77-79	KA-1200		RC-2314*	22-8028PK	KN-401	*Inc. 4 Filters
650	KZ650D SR	78-79	KA-1200		RC-2314*	22-8028PK	KN-401	*Inc. 4 Filters
650	KZ650E LTD	80	KA-1200		RC-2314*	22-8028PK	KN-401	*Inc. 4 Filters
650	KZ650F	80	KA-1200		RC-2314*	22-8028PK	KN-401	*Inc. 4 Filters
650	KZ650H CSR	78-80					KN-401	
650	KZ650H CSR	81-82	KA-7580				KN-401	
650	KZ650H CSR	83	KA-7580*				KN-401	*US
650	W650	99-05					KN-204*	*Chrome=KN-204C
650	W650	06-08					KN-303*	*Chrome=KN-303C
650	Z650	80-83					KN-401	
650	Z650SR	78-80					KN-401	
652	KL650 Tengai	90-91	KA-6589	KA-6589PL			KN-123	
652	KL650 Tengai	92					KN-123	
652	ZX600 Ninja	85-87	KA-0850		RC-1824*	RC-1820DK	KN-401	*Inc. 4 Filters
700	KZ700	84	KA-7580				KN-401	
700	VN700 Vulcan	84-85					KN-202	
700	ZN700 LTD	84-85	KA-7580				KN-401	
737	ZXR750	90	KA-7589				KN-303*	*Chrome=KN-303C
739	GT750	90-96					KN-401	
749	VN750 Vulcan	86-98	KA-7586				KN-202	
749	VN750 Vulcan	99-03	KA-7586				KN-303*	*Chrome=KN-303C
749	VN750 Vulcan	04-06	KA-7586				KN-204*	*Chrome=KN-204C
750	GPX750R	86					KN-401	
750	GPX750R	87-89	KA-7587		RC-2914*		KN-401	*Inc. 4 Filters
750	GPZ750	82-85	KA-7583		RC-0984*	RC-1820DK	KN-401	*Inc. 4 Filters
750	GPZ750	86-89					KN-401	
750	GPZ750R	85-88					KN-401	
750	GT750	82-89					KN-401	
750	H2 Mach IV	72-75	KA-1100					
750	KZ750 Twin	76-79	KA-0750		RC-0982*	RC-1820DK	KN-126	*Inc. 2 Filters
750	KZ750E	80-82	KA-7580		RC-0984*	RC-1820DK	KN-401	*Inc. 4 Filters
750	KZ750F LTD	83	KA-7583		RC-0984*	RC-1820DK	KN-401	*Inc. 4 Filters
750	KZ750G LTD Twin	80	KA-7500		RC-0982*	RC-1820DK	KN-126	*Inc. 2 Filters
750	KZ750H LTD	80-83	KA-7580		RC-0984*	RC-1820DK	KN-401	*Inc. 4 Filters
750	KZ750K LTD Twin	83-84	KA-7500		RC-0982*	RC-1820DK	KN-126	*Inc. 2 Filters
750	KZ750L	83	KA-7583		RC-0984*	RC-1820DK	KN-401	*Inc. 4 Filters
750	KZ750M CSR Twin	82	KA-7500		RC-0982*	RC-1820DK	KN-126	*Inc. 2 Filters

2) Requires Two; 3) Requires Three; 4) Requires Four. The use of custom air filter requires removal of air box. Some custom filters and intakes are not legal for sale or use on any pollution controlled motor vehicle in California or states adopting California emission procedures. See knfilters.com for CARB status on each part for a specific vehicle.

Motorcycle - Application Listing



CC	Model	Year	Air Filter	Air Filter Precharger	Custom	Custom Precharger	Oil Filter	Comments
KAWASAKI								
750	KZ750N Spectre	82-83	KA-7583		RC-0984*	RC-1820DK	KN-401	*Inc. 4 Filters
750	Z750	76					KN-126	
750	Z750	81-82					KN-401	
750	Z750	84-87					KN-401	
750	Z750	04-06	KA-1003				KN-204*	*Chrome=KN-204C
750	Z750	07-12	KA-1003				KN-303*	*Chrome=KN-303C
750	Z750 LTD	78-82					KN-126	
750	Z750R	11-12	KA-1003				KN-303*	*Chrome=KN-303C
750	Z750S	05-06	KA-1003				KN-204*	*Chrome=KN-204C
750	Z750S	07	KA-1003				KN-303*	*Chrome=KN-303C
750	Z750S	09					KN-303*	*Chrome=KN-303C
750	ZR7	99-01	KA-0850				KN-401	
750	ZR7	02-03					KN-401	
750	ZR750 Zephyr	91-99	KA-0850				KN-401	
750	ZR750 Zephyr	01-06	KA-0850				KN-401	
750	ZR7S	01-05	KA-0850				KN-401	
750	ZX7 Ninja	89	KA-7589				KN-303*	*Chrome=KN-303C
750	ZX7 Ninja	90	KA-7589				KN-401	
750	ZX7 Ninja	91-92					KN-303*	*Chrome=KN-303C
750	ZX7 Ninja	93-95	KA-0007				KN-303*	*Chrome=KN-303C
750	ZX750	83-85	KA-7583		RC-0984*	RC-1820DK	KN-401	*Inc. 4 Filters
750	ZX750	86					KN-401	
750	ZX750	93-99					KN-303*	*Chrome=KN-303C
750	ZX750 Ninja	87-90	KA-7587		RC-2914*		KN-401	*Inc. 4 Filters
750	ZX750 Turbo	84-85					KN-401	
750	ZX7R Ninja	91-92					KN-303*	*Chrome=KN-303C
750	ZX7R Ninja	93-94	KA-0007				KN-303*	*Chrome=KN-303C
750	ZX7R Ninja	96-03	KA-7596				KN-303*	*Chrome=KN-303C
750	ZX7RR Ninja	96-97	KA-7596				KN-303*	*Chrome=KN-303C
750	ZX7RR Ninja	98-99					KN-303*	*Chrome=KN-303C
750	ZXR750	89	KA-7589				KN-303*	*Chrome=KN-303C
750	ZXR750R	93-95					KN-303*	*Chrome=KN-303C
800	VN800 Vulcan	95-02	KA-8095				KN-303*	*Chrome=KN-303C
800	VN800 Vulcan	03-05	KA-8095				KN-204*	*Chrome=KN-204C
800	VN800 Vulcan Classic	96-00	KA-8095				KN-303*	*Chrome=KN-303C
800	VN800 Vulcan Classic	04-05	KA-8095				KN-204*	*Chrome=KN-204C
800	VN800 Vulcan Drifter	99-02	KA-8095				KN-303*	*Chrome=KN-303C
800	VN800 Vulcan Drifter	03-06	KA-8095				KN-204*	*Chrome=KN-204C
803	VN800 Vulcan Classic	01	KA-8095				KN-303*	*Chrome=KN-303C
803	VN800 Vulcan Classic	02-03	KA-8095				KN-204*	*Chrome=KN-204C
806	Z800	13-14	KA-1003				KN-303*	*Chrome=KN-303C
806	Z800	15	KA-1003					
806	Z800	16	KA-1003				KN-303*	*Chrome=KN-303C
900	GPZ900R	84-90					KN-401	
900	GPZ900R	91-93	KA-9084				KN-401	
900	GPZ900R	94-96					KN-401	
900	GPZ900R	98-03	KA-9084				KN-401	
900	KZ900A	76-77	KA-8076		RC-2454*	RC-1820DK	KN-126	*Inc. 4 Filters
900	KZ900B LTD	76	KA-8076		RC-2454*	RC-1820DK	KN-126	*Inc. 4 Filters
900	Z1	73-75	KA-0800		RC-2454*	RC-1820DK	KN-126	*Inc. 4 Filters
900	Z1F	76					KN-401	
900	ZL900 Eliminator	85-86	KA-9084		RC-2774*		KN-401	*Inc. 4 Filters
900	ZX900 Ninja	84-86	KA-9084		RC-2814*		KN-401	*Inc. 4 Filters
900	ZX9R Ninja	94-97	KA-9094				KN-303*	*Chrome=KN-303C
900	ZX9R Ninja	98-01	KA-9098				KN-303*	*Chrome=KN-303C

2) Requires Two; 3) Requires Three; 4) Requires Four. The use of custom air filter requires removal of air box. Some custom filters and intakes are not legal for sale or use on any pollution controlled motor vehicle in California or states adopting California emission procedures. See knfilters.com for CARB status on each part for a specific vehicle.



Motorcycle - Application Listing

CC	Model	Year	Air Filter	Air Filter Precharger	Custom	Custom Precharger	Oil Filter	Comments
KAWASAKI								
900	ZX9R Ninja	02-03	KA-9098				KN-204*	*Chrome=KN-204C
903	VN900 Vulcan Classic	06-16	KA-9006				KN-303*	*Chrome=KN-303C
903	VN900 Vulcan Classic LT	06-16	KA-9006				KN-303*	*Chrome=KN-303C
903	VN900 Vulcan Custom	07-16	KA-9006				KN-303*	*Chrome=KN-303C
998	KZ1000 Police	78-81	KA-8077		RC-2454*	RC-1820DK	KN-126	*Inc. 4 Filters
998	KZ1000P Police	82-99	KA-1600		RC-0984*	RC-1820DK	KN-401	*Inc. 4 Filters
998	KZ1000P Police	00-01	KA-1600				KN-401	
998	ZG1000 Concours	02-03	KA-9084		RC-1824*	RC-1820DK	KN-401	*Inc. 4 Filters
998	ZG1000 Concours	04-06	KA-9084				KN-401	
998	ZX1000 Ninja 1000 ABS	15-16	KA-1111				KN-303*	*Chrome=KN-303C
998	ZX1000 Ninja H2	15-16	KA-9915				KN-303*	*Chrome=KN-303C
998	ZX1000 Ninja H2R	15-16					KN-303*	*Chrome=KN-303C
998	ZX1000 Ninja ZX-10R	16	KA-1016				KN-303*	*Chrome=KN-303C
998	ZX1000 Ninja ZX-10R ABS	16	KA-1016				KN-303*	*Chrome=KN-303C
998	ZX1000 Ninja ZX-10R ABS KRT Edition	16	KA-1016				KN-303*	*Chrome=KN-303C
998	ZX1000 Ninja ZX-10R KRT Edition	16	KA-1016				KN-303*	*Chrome=KN-303C
1000	GPZ1000RX	85-87	KA-0002		RU-2852*		KN-401	*Inc. 2 Filters
1000	GPZ1000RX	88-89					KN-401	
1000	KLV1000	04-05	SU-1002				KN-138*	*Chrome=KN-138C
1000	KLV1000	06					KN-138*	*Chrome=KN-138C
1000	KLZ1000 Versys LT	12-13					KN-303*	*Chrome=KN-303C
1000	KLZ1000 Versys LT	15-16					KN-303*	*Chrome=KN-303C
1000	KZ1000 LTD	77-80	KA-8077		RC-2454*	RC-1820DK	KN-126	*Inc. 4 Filters
1000	KZ1000 LTD	81	KA-1600		RC-0984*	RC-1820DK	KN-401	*Inc. 4 Filters
1000	KZ1000A	77-80	KA-8077		RC-2454*	RC-1820DK	KN-126	*Inc. 4 Filters
1000	KZ1000D Z1-R	78	KA-8077		RC-2454*	RC-1820DK	KN-126	*Inc. 4 Filters
1000	KZ1000D Z1-R	79					KN-126	
1000	KZ1000D Z1-R	80	KA-8077		RC-2454*	RC-1820DK	KN-126	*Inc. 4 Filters
1000	KZ1000E	78					KN-126	
1000	KZ1000E	79-80	KA-1150		RC-2454*	RC-1820DK	KN-126	*Inc. 4 Filters
1000	KZ1000G Classic	80					KN-126	
1000	KZ1000J	81	KA-1600		RC-0984*	RC-1820DK	KN-126	*Inc. 4 Filters
1000	KZ1000J	82-83	KA-1600		RC-0984*	RC-1820DK	KN-401	*Inc. 4 Filters
1000	KZ1000K LTD	82	KA-1600		RC-0984*	RC-1820DK	KN-401	*Inc. 4 Filters
1000	KZ1000M CSR	81-82	KA-1600		RC-0984*	RC-1820DK	KN-401	*Inc. 4 Filters
1000	KZ1000P Police	02-05	KA-1600				KN-401	
1000	KZ1000R	82-83	KA-1600		RC-0984*	RC-1820DK	KN-401	*Inc. 4 Filters
1000	Z1000	74-75					KN-126	
1000	Z1000	81-83					KN-303*	*Chrome=KN-303C
1000	Z1000	03-06	KA-1003				KN-204*	*Chrome=KN-204C
1000	Z1000	07-09	KA-1003				KN-303*	*Chrome=KN-303C
1000	Z1000	10	KA-1010				KN-303*	*Chrome=KN-303C
1000	Z1000	11	KA-1010*				KN-303**	*Before VIN ZRT00DE010765/ **Chrome=KN-303C
1000	Z1000	11	KA-1111*				KN-303**	*After VIN ZRT00DE010766/ **Chrome=KN-303C
1000	Z1000	12-15	KA-1111				KN-303*	*Chrome=KN-303C
1000	Z1000 LTD	81-82					KN-303*	*Chrome=KN-303C
1000	Z1000 ST	79-80					KN-126	
1000	Z1000 SX	11-12	KA-1111				KN-303*	*Chrome=KN-303C
1000	Z1000A	77-81					KN-126	
1000	Z1R	78					KN-126	
1000	ZG1000 Concours	86-01	KA-9084		RC-1824*	RC-1820DK	KN-401	*Inc. 4 Filters
1000	ZL1000 Eliminator	87	KA-9084		RC-0984*	RC-1820DK	KN-401	*Inc. 4 Filters
1000	ZL1000 Eliminator	88					KN-401	
1000	ZR1000 ABS	07-09					KN-303*	*Chrome=KN-303C

2) Requires Two; 3) Requires Three; 4) Requires Four. The use of custom air filter requires removal of air box. Some custom filters and intakes are not legal for sale or use on any pollution controlled motor vehicle in California or states adopting California emission procedures. See knfilters.com for CARB status on each part for a specific vehicle.

Motorcycle - Application Listing



CC	Model	Year	Air Filter	Air Filter Precharger	Custom	Custom Precharger	Oil Filter	Comments
KAWASAKI								
1000	ZR1000 ABS	16					KN-303*	*Chrome=KN-303C
1000	ZX1000 Ninja ZX-10	88-90	KA-1088		RU-2952*		KN-401	*Inc. 2 Filters
1000	ZX1000 Ninja ZX-10R	04-06	KA-1004				KN-204*	*Chrome=KN-204C
1000	ZX1000 Ninja ZX-10R	07	KA-1004				KN-303*	*Chrome=KN-303C
1000	ZX1000 Ninja ZX-10R	08-10	KA-1008				KN-303*	*Chrome=KN-303C
1000	ZX1000 Ninja ZX-10R	08-10	KA-1008R*				KN-303**	*Race Specific/ **Chrome=KN-303C
1000	ZX1000 Ninja ZX-10R	11-15	KA-1011				KN-303*	*Chrome=KN-303C
1000	ZX1000 Ninja ZX-10R	11-15	KA-1011R*				KN-303**	*Race Specific/ **Chrome=KN-303C
1000	ZX1000 Ninja ZX-10R 30th Anniversary	15	KA-1011				KN-303*	*Chrome=KN-303C
1000	ZX1000 Ninja ZX-10R 30th Anniversary	15	KA-1011R*				KN-303**	*Race Specific/ **Chrome=KN-303C
1000	ZX1000 Ninja ZX-10R ABS	11-15	KA-1011				KN-303*	*Chrome=KN-303C
1000	ZX1000 Ninja ZX-10R ABS	11-15	KA-1011R*				KN-303**	*Race Specific/ **Chrome=KN-303C
1000	ZX1000 Ninja ZX-10R ABS 30th Anniversary	15	KA-1011				KN-303*	*Chrome=KN-303C
1000	ZX1000 Ninja ZX-10R ABS 30th Anniversary	15	KA-1011R*				KN-303**	*Race Specific/ **Chrome=KN-303C
1000	ZX1000R Ninja	85-87	KA-0002		RU-2852*		KN-401	*Inc. 2 Filters
1043	Versys 1000	12-14	KA-1111					
1043	Versys 1000	15-16	KA-1111				KN-303*	*Chrome=KN-303C
1043	Z1000	16	KA-1111				KN-303*	*Chrome=KN-303C
1043	Z1000 SX	16	KA-1111				KN-303*	*Chrome=KN-303C
1043	ZX1000 Ninja 1000	11-13	KA-1111				KN-303*	*Chrome=KN-303C
1043	ZX1000 Ninja 1000 ABS	12-14	KA-1111				KN-303*	*Chrome=KN-303C
1100	GPZ1100	81-82					KN-401	
1100	GPZ1100	83-84	KA-1183		RC-2454*	RC-1820DK	KN-401	*Inc. 4 Filters
1100	GPZ1100	85					KN-401	
1100	GPZ1100	95-98					KN-401	
1100	GPZ1100 ABS	97					KN-401	
1100	KZ1100A	81-83	KA-1600		RC-0984*	RC-1820DK	KN-401	*Inc. 4 Filters
1100	KZ1100B GPz	81-82			RC-0984*	RC-1820DK	KN-401	*Inc. 4 Filters
1100	KZ1100D Spectre	82-83	KA-1600		RC-0984*	RC-1820DK	KN-401	*Inc. 4 Filters
1100	KZ1100L LTD	83	KA-1600		RC-0984*	RC-1820DK	KN-401	*Inc. 4 Filters
1100	Z1100	81-86					KN-401	
1100	ZN1100B LTD	84-85			RC-0984*	RC-1820DK	KN-401	*Inc. 4 Filters
1100	ZR1100 Zephyr	91					KN-401	
1100	ZR1100 Zephyr	92-95	KA-1192				KN-401	
1100	ZR1100 Zephyr	96					KN-401	
1100	ZR1100 Zephyr	99	KA-1192				KN-401	
1100	ZR1100 Zephyr	02-06					KN-401	
1100	ZR1100 Zephyr RS	96-97	KA-1192				KN-401	
1100	ZR1100 Zephyr RS	99	KA-1192				KN-401	
1100	ZRX1100	96					KN-401	
1100	ZRX1100	97-00	KA-1199				KN-401	
1100	ZX11 Ninja	93-01	KA-1093				KN-401	
1100	ZZR1100	90-92	KA-0004				KN-401	
1100	ZZR1100	93-01	KA-1093				KN-401	
1185	ZG1200 Voyager XII	94-03					KN-401	
1196	ZG1200 Voyager XII	93					KN-401	
1198	ZG1200 Voyager XII	86-92					KN-401	
1198	ZX11C Ninja	90-93	KA-0004				KN-401	
1200	ZRX1200	01-06	KA-1199				KN-401	
1200	ZRX1200 Daeg	09	KA-1199				KN-401	
1200	ZRX1200R	07-08	KA-1199				KN-401	
1200	ZX12R Ninja	00-06	KA-1299-1				KN-204*	*Chrome=KN-204C

2) Requires Two; 3) Requires Three; 4) Requires Four. The use of custom air filter requires removal of air box. Some custom filters and intakes are not legal for sale or use on any pollution controlled motor vehicle in California or states adopting California emission procedures. See knfilters.com for CARB status on each part for a specific vehicle.



Motorcycle - Application Listing

CC	Model	Year	Air Filter	Air Filter Precharger	Custom	Custom Precharger	Oil Filter	Comments
KAWASAKI								
1200	ZZR1200	02-05	KA-1093				KN-401	
1300	KZ1300	79-82	KA-1350				KN-126	
1300	KZ1300	83					KN-126	
1300	ZN1300 Voyager	83-88	KA-0883				KN-126	
1400	1400GTR	08-11	KA-1406				KN-303*	*Chrome=KN-303C
1400	1400GTR	12					KN-303*	*Chrome=KN-303C
1400	ZG1400 Concours	08-11	KA-1406				KN-303*	*Chrome=KN-303C
1400	ZG1400 Concours	12-14	KA-1406*				KN-303**	*US/ **Chrome=KN-303C
1400	ZG1400 Concours ABS	15-16					KN-303*	*Chrome=KN-303C
1400	ZX14R Ninja	06-11	KA-1406				KN-303*	*Chrome=KN-303C
1400	ZZR1400	06-11	KA-1406				KN-303*	*Chrome=KN-303C
1400	ZZR1400	12					KN-303*	*Chrome=KN-303C
1441	ZX1400 Ninja ZX-14R ABS	15					KN-303*	*Chrome=KN-303C
1441	ZX1400 Ninja ZX-14R ABS 30th Anniversary	15					KN-303*	*Chrome=KN-303C
1441	ZX1400 Ninja ZX-14R ABS SE	16					KN-303*	*Chrome=KN-303C
1441	ZX14R Ninja	12-14					KN-303*	*Chrome=KN-303C
1441	ZX14R Ninja	16					KN-303*	*Chrome=KN-303C
1500	VN1500 Vulcan	87-89	KA-1594*				KN-303**	*Exc. SE/ **Chrome=KN-303C
1500	VN1500 Vulcan	90-99	KA-1594				KN-303*	*Chrome=KN-303C
1500	VN1500 Vulcan 88	87-89					KN-303*	*Chrome=KN-303C
1500	VN1500 Vulcan 88	91-93					KN-303*	*Chrome=KN-303C
1500	VN1500 Vulcan 88	95-97					KN-303*	*Chrome=KN-303C
1500	VN1500 Vulcan 88 SE	87-89					KN-303*	*Chrome=KN-303C
1500	VN1500 Vulcan Classic	96-98	KA-1596				KN-303*	*Chrome=KN-303C
1500	VN1500 Vulcan Classic	99-06	KA-1596				KN-204*	*Chrome=KN-204C
1500	VN1500 Vulcan Classic	07-08	KA-1596				KN-303*	*Chrome=KN-303C
1500	VN1500 Vulcan Classic F/I	00-02	KA-1596				KN-204*	*Chrome=KN-204C
1500	VN1500 Vulcan Classic Tourer F/I	99	KA-1596				KN-303*	*Chrome=KN-303C
1500	VN1500 Vulcan Classic Tourer F/I	00					KN-303*	*Chrome=KN-303C
1500	VN1500 Vulcan Classic Tourer F/I	01					KN-204*	*Chrome=KN-204C
1500	VN1500 Vulcan Classic Tourer F/I	02-03	KA-1596				KN-204*	*Chrome=KN-204C
1500	VN1500 Vulcan Drifter	99-05	KA-1596				KN-204*	*Chrome=KN-204C
1500	VN1500 Vulcan L	96-97	KA-1594				KN-303*	*Chrome=KN-303C
1500	VN1500 Vulcan Mean Streak	02-03	KA-1596				KN-204*	*Chrome=KN-204C
1500	VN1500 Vulcan Nomad	98	KA-1596				KN-303*	*Chrome=KN-303C
1500	VN1500 Vulcan Nomad	99-01	KA-1596				KN-204*	*Chrome=KN-204C
1500	VN1500 Vulcan Nomad F/I	00	KA-1596				KN-303*	*Chrome=KN-303C
1500	VN1500 Vulcan Nomad F/I	01-04	KA-1596				KN-204*	*Chrome=KN-204C
1500	VN1500 Vulcan Voyager	87-93					KN-303*	*Chrome=KN-303C
1500	VN1500 Vulcan VV	94-95					KN-303*	*Chrome=KN-303C
1553	VN1600 Vulcan Classic	03	KA-1603				KN-204*	*Chrome=KN-204C
1600	VN1600 Vulcan Classic	04-06	KA-1603				KN-204*	*Chrome=KN-204C
1600	VN1600 Vulcan Classic	07-08	KA-1603				KN-303*	*Chrome=KN-303C
1600	VN1600 Vulcan Mean Streak	04-06	KA-1596				KN-204*	*Chrome=KN-204C
1600	VN1600 Vulcan Mean Streak	07-08	KA-1596				KN-303*	*Chrome=KN-303C
1600	VN1600 Vulcan Nomad	05-06	KA-1603				KN-204*	*Chrome=KN-204C
1600	VN1600 Vulcan Nomad	07-08	KA-1603				KN-303*	*Chrome=KN-303C
1700	VN1700 Vulcan Classic	09-12	KA-1709				KN-303*	*Chrome=KN-303C
1700	VN1700 Vulcan Classic LT	09-10	KA-1709				KN-303*	*Chrome=KN-303C
1700	VN1700 Vulcan Nomad	09-16	KA-1709				KN-303*	*Chrome=KN-303C
1700	VN1700 Vulcan Vaquero	11-15	KA-1709				KN-303*	*Chrome=KN-303C
1700	VN1700 Vulcan Vaquero	16					KN-303*	*Chrome=KN-303C
1700	VN1700 Vulcan Voyager	09-15	KA-1709				KN-303*	*Chrome=KN-303C
1700	VN1700 Vulcan Voyager ABS	13	KA-1709				KN-303*	*Chrome=KN-303C
1700	VN1700 Vulcan Voyager ABS	16	KA-1709				KN-303*	*Chrome=KN-303C

2) Requires Two; 3) Requires Three; 4) Requires Four. The use of custom air filter requires removal of air box. Some custom filters and intakes are not legal for sale or use on any pollution controlled motor vehicle in California or states adopting California emission procedures. See knfilters.com for CARB status on each part for a specific vehicle.

Motorcycle - Application Listing



CC	Model	Year	Air Filter	Air Filter Precharger	Custom	Custom Precharger	Oil Filter	Comments
KAWASAKI								
2000	VN2000 Vulcan	04-06	KA-2008		RK-3908*	E-3016DK	KN-204**	*Mirrored/ **Chrome=KN-204C
2000	VN2000 Vulcan	04-06	KA-2008		RK-3918*	E-3016DK	KN-204**	*Grooved/ **Chrome=KN-204C
2000	VN2000 Vulcan	04-06	KA-2008		RK-3928*	E-3016DK	KN-204**	*Flamed/ **Chrome=KN-204C
2000	VN2000 Vulcan	07	KA-2008		RK-3908*	E-3016DK	KN-303**	*Mirrored/ **Chrome=KN-303C
2000	VN2000 Vulcan	07	KA-2008		RK-3918*	E-3016DK	KN-303**	*Grooved/ **Chrome=KN-303C
2000	VN2000 Vulcan	07	KA-2008		RK-3928*	E-3016DK	KN-303**	*Flamed/ **Chrome=KN-303C
2000	VN2000 Vulcan	08-09	KA-2008				KN-303*	*Chrome=KN-303C
2000	VN2000 Vulcan Classic	06	KA-2008		RK-3908*	E-3016DK	KN-204**	*Mirrored/ **Chrome=KN-204C
2000	VN2000 Vulcan Classic	06	KA-2008		RK-3918*	E-3016DK	KN-204**	*Grooved/ **Chrome=KN-204C
2000	VN2000 Vulcan Classic	06	KA-2008		RK-3928*	E-3016DK	KN-204**	*Flamed/ **Chrome=KN-204C
2000	VN2000 Vulcan Classic	07	KA-2008		RK-3908*	E-3016DK	KN-303**	*Mirrored/ **Chrome=KN-303C
2000	VN2000 Vulcan Classic	07	KA-2008		RK-3918*	E-3016DK	KN-303**	*Grooved/ **Chrome=KN-303C
2000	VN2000 Vulcan Classic	07	KA-2008		RK-3928*	E-3016DK	KN-303**	*Flamed/ **Chrome=KN-303C
2000	VN2000 Vulcan Classic	08-09	KA-2008				KN-303*	*Chrome=KN-303C
2000	VN2000 Vulcan Classic LT	04-05	KA-2008				KN-204*	*Chrome=KN-204C
2000	VN2000 Vulcan Classic LT	06	KA-2008		RK-3908*	E-3016DK	KN-204**	*Mirrored/ **Chrome=KN-204C
2000	VN2000 Vulcan Classic LT	06	KA-2008		RK-3918*	E-3016DK	KN-204**	*Grooved/ **Chrome=KN-204C
2000	VN2000 Vulcan Classic LT	06	KA-2008		RK-3928*	E-3016DK	KN-204**	*Flamed/ **Chrome=KN-204C
2000	VN2000 Vulcan Classic LT	07	KA-2008		RK-3908*	E-3016DK	KN-303**	*Mirrored/ **Chrome=KN-303C
2000	VN2000 Vulcan Classic LT	07	KA-2008		RK-3918*	E-3016DK	KN-303**	*Grooved/ **Chrome=KN-303C
2000	VN2000 Vulcan Classic LT	07	KA-2008		RK-3928*	E-3016DK	KN-303**	*Flamed/ **Chrome=KN-303C
2000	VN2000 Vulcan Classic LT	08-10	KA-2008				KN-303*	*Chrome=KN-303C
2000	VN2000 Vulcan Limited	06	KA-2008		RK-3908*	E-3016DK	KN-204**	*Mirrored/ **Chrome=KN-204C
2000	VN2000 Vulcan Limited	06	KA-2008		RK-3918*	E-3016DK	KN-204**	*Grooved/ **Chrome=KN-204C
2000	VN2000 Vulcan Limited	06	KA-2008		RK-3928*	E-3016DK	KN-204**	*Flamed/ **Chrome=KN-204C
KTM								
85	85 SX 17/14	07	KT-5201	KT-5201DK				
85	85 SX 19/16	07	KT-5201	KT-5201DK				
105	105 SX	07	KT-5201	KT-5201DK				
124	125 SX	98-06	KT-5201	KT-5201DK				
124	125 SX	07-15	KT-4511XD	KT-4511DK				
124	125 SXS	01-06	KT-5201	KT-5201DK				
124	125 SXS	07-08	KT-4511XD	KT-4511DK				
124	RC125	14	KT-1211					
125	125 Duke	11-16	KT-1211				KN-155	
125	125 EGS 6KW	98-99	KT-5201	KT-5201DK				
125	125 EXC	98-05	KT-5201	KT-5201DK				
125	125 EXC	12-16	KT-4511XD	KT-4511DK				
125	125 EXC 100	01	KT-5201	KT-5201DK				
125	125 EXC 80	01	KT-5201	KT-5201DK				
125	125 EXC Six Days	04-06	KT-5201	KT-5201DK				
125	125 EXE 100	00	KT-5201	KT-5201DK				
125	125 EXE 80	00	KT-5201	KT-5201DK				
125	125 Supermoto 100	00-01	KT-5201	KT-5201DK				
125	125 Supermoto 80	00-01	KT-5201	KT-5201DK				
144	144 SX	07-08	KT-4511XD	KT-4511DK				
144	150 SX	09-15	KT-4511XD	KT-4511DK				
144	150 XC	10-14	KT-4511XD	KT-4511DK				
193	200 XC	06-07	KT-5201	KT-5201DK				
193	200 XC	08-09	KT-4511XD	KT-4511DK				
193	200 XC-W	06-07	KT-5201	KT-5201DK				
193	200 XC-W	08-16	KT-4511XD	KT-4511DK				
199	RC200	14	KT-1211					
200	200 Duke	12-16	KT-1211				KN-155	
200	200 EGS	98-99	KT-5201	KT-5201DK				

2) Requires Two; 3) Requires Three; 4) Requires Four. The use of custom air filter requires removal of air box. Some custom filters and intakes are not legal for sale or use on any pollution controlled motor vehicle in California or states adopting California emission procedures. See knfilters.com for CARB status on each part for a specific vehicle.



Motorcycle - Application Listing

CC	Model	Year	Air Filter	Air Filter Precharger	Custom	Custom Precharger	Oil Filter	Comments
KTM								
200	200 EXC	98-05	KT-5201	KT-5201DK				
200	200 EXC	08-16	KT-4511XD	KT-4511DK				
200	200 MXC	98-03	KT-5201	KT-5201DK				
200	200 SX	03-04	KT-5201	KT-5201DK				
200	RC200	15-16	KT-1211					
249	250 SX	98-06	KT-5201	KT-5201DK				
249	250 SX	07	KT-4511XD	KT-4511DK				
249	250 SX	08	KT-4511XD	KT-4511DK			KN-655	
249	250 SX	10	KT-4511XD	KT-4511DK			KN-655	
249	250 SX	11-14	KT-4511XD	KT-4511DK				
249	250 SX	15	KT-4511XD	KT-4511DK			KN-652	
249	250 SX	16	KT-4511XD	KT-4511DK				
249	250 SX-F	05-06	KT-5201	KT-5201DK			KN-655	
249	250 SX-F	07-12	KT-4511XD	KT-4511DK			KN-655	
249	250 SX-F	13					KN-652	
249	250 SX-F	14	KT-4511XD	KT-4511DK			KN-652	
249	250 SX-F	15-16					KN-652	
249	250 SXS	01	KT-5201	KT-5201DK				
249	250 SXS	03-06	KT-5201	KT-5201DK				
249	250 SXS	07	KT-4511XD	KT-4511DK			KN-655	
249	250 SXS-F	06	KT-5201	KT-5201DK			KN-655	
249	250 SXS-F	07-08	KT-4511XD	KT-4511DK			KN-655	
249	250 XC	06-07	KT-5201	KT-5201DK				
249	250 XC	08	KT-4511XD	KT-4511DK				
249	250 XC	09-10	KT-4511XD	KT-4511DK			KN-655	
249	250 XC	11-16	KT-4511XD	KT-4511DK				
249	250 XC-F	07	KT-5201	KT-5201DK			KN-655	
249	250 XC-F	08-09	KT-4511XD	KT-4511DK			KN-655	
249	250 XC-F	11-12	KT-4511XD	KT-4511DK			KN-655	
249	250 XC-F	13-16					KN-652	
249	250 XCF-W	06-07	KT-5201	KT-5201DK			KN-655	
249	250 XCF-W	08-13	KT-4511XD	KT-4511DK			KN-655	
249	250 XCF-W	14-16					KN-652	
249	250 XC-W	06-07	KT-5201	KT-5201DK				
249	250 XC-W	08	KT-4511XD	KT-4511DK				
249	250 XC-W	09-10	KT-4511XD	KT-4511DK			KN-655	
249	250 XC-W	11-16	KT-4511XD	KT-4511DK				
250	250 Duke	15-16	KT-1211					
250	250 EGS	98-99	KT-5201	KT-5201DK				
250	250 EXC	98-00	KT-5201	KT-5201DK				
250	250 EXC	02	KT-5201	KT-5201DK			KN-155*	*Tall Filter
250	250 EXC	02	KT-5201	KT-5201DK			KN-157*	*Short Filter
250	250 EXC	03	KT-5201	KT-5201DK				
250	250 EXC	04-05	KT-5201	KT-5201DK			KN-155*	*Tall Filter
250	250 EXC	04-05	KT-5201	KT-5201DK			KN-157*	*Short Filter
250	250 EXC	08-09	KT-4511XD	KT-4511DK				
250	250 EXC	10-16	KT-4511XD	KT-4511DK			KN-655	
250	250 EXC Racing	01	KT-5201	KT-5201DK			KN-155*	*Tall Filter
250	250 EXC Racing	01	KT-5201	KT-5201DK			KN-157*	*Short Filter
250	250 EXC Racing	03	KT-5201	KT-5201DK			KN-155*	*Tall Filter
250	250 EXC Racing	03	KT-5201	KT-5201DK			KN-157*	*Short Filter
250	250 EXC Racing	06					KN-155*	*Tall Filter
250	250 EXC Racing	06					KN-157*	*Short Filter
250	250 EXC Six Days	12					KN-655	
250	250 EXC-F	07					KN-655	

2) Requires Two; 3) Requires Three; 4) Requires Four. The use of custom air filter requires removal of air box. Some custom filters and intakes are not legal for sale or use on any pollution controlled motor vehicle in California or states adopting California emission procedures. See knfilters.com for CARB status on each part for a specific vehicle.

Motorcycle - Application Listing



CC	Model	Year	Air Filter	Air Filter Precharger	Custom	Custom Precharger	Oil Filter	Comments
KTM								
250	250 EXC-F	08-09	KT-4511XD	KT-4511DK			KN-655	
250	250 EXC-F Six Days	10-12					KN-655	
250	250 EXC-G Racing	03	KT-5201	KT-5201DK			KN-155*	*Tall Filter
250	250 EXC-G Racing	03	KT-5201	KT-5201DK			KN-157*	*Short Filter
250	250 MXC	98-01	KT-5201	KT-5201DK				
293	300 XC	06-07	KT-5201	KT-5201DK				
293	300 XC	08-16	KT-4511XD	KT-4511DK				
293	300 XC-W	06-07	KT-5201	KT-5201DK				
293	300 XC-W	08-16	KT-4511XD	KT-4511DK				
300	300 EGS	98-99	KT-5201	KT-5201DK				
300	300 EXC	98-05	KT-5201	KT-5201DK				
300	300 EXC-E	08-16	KT-4511XD	KT-4511DK				
300	300 MXC	00-05	KT-5201	KT-5201DK				
300	300 MXC 12LT	98-99	KT-5201	KT-5201DK				
349	350 SX-F	11-16					KN-652	
350	350 EXC-F	12-16					KN-652	
350	350 Freeride	12					KN-652	
350	350 XC-F	11-16					KN-652	
350	350 XCF-W	12-16					KN-652	
368	380 EGS	98-99	KT-5201	KT-5201DK				
368	380 EXC	98-02	KT-5201	KT-5201DK				
368	380 MXC	00-01	KT-5201	KT-5201DK				
368	380 MXC 12LT	98-99	KT-5201	KT-5201DK				
368	380 SX	98-02	KT-5201	KT-5201DK				
373	RC390	14	KT-1211					
373	RC390	15	KT-1211				KN-155	
373	RC390	16	KT-1211					
390	390 Duke	13-14	KT-1211					
390	390 Duke	15-16	KT-1211				KN-155	
398	400 Duke	94-95					KN-155*	*Short Filter
398	400 Duke	94-95					KN-156*	*Tall Filter
398	400 LSE	97					KN-155*	*Short Filter
398	400 LSE	97					KN-156*	*Tall Filter
400	400 EGS	94					KN-155*	*Short Filter
400	400 EGS	94					KN-156*	*Tall Filter
400	400 EGS	96-97					KN-155*	*Short Filter
400	400 EGS	96-97					KN-156*	*Tall Filter
400	400 EXC	99					KN-155*	*Short Filter
400	400 EXC	99					KN-156*	*Tall Filter
400	400 EXC	00	KT-5201	KT-5201DK			KN-155*	*Tall Filter
400	400 EXC	00	KT-5201	KT-5201DK			KN-157*	*Short Filter
400	400 EXC	01					KN-155*	*Tall Filter
400	400 EXC	01					KN-157*	*Short Filter
400	400 EXC	02	KT-5201	KT-5201DK			KN-155*	*Tall Filter
400	400 EXC	02	KT-5201	KT-5201DK			KN-157*	*Short Filter
400	400 EXC	03					KN-155*	*Tall Filter
400	400 EXC	03					KN-157*	*Short Filter
400	400 EXC	04-06	KT-5201	KT-5201DK			KN-155*	*Tall Filter
400	400 EXC	04-06	KT-5201	KT-5201DK			KN-157*	*Short Filter
400	400 EXC	07					KN-155*	*Tall Filter
400	400 EXC	07					KN-157*	*Short Filter
400	400 EXC	08-11					KN-652	
400	400 LC4	98-02					KN-155*	*Short Filter
400	400 LC4	98-02					KN-156*	*Tall Filter
400	400 MXC	99-00					KN-155*	*Tall Filter

2) Requires Two; 3) Requires Three; 4) Requires Four. The use of custom air filter requires removal of air box. Some custom filters and intakes are not legal for sale or use on any pollution controlled motor vehicle in California or states adopting California emission procedures. See knfilters.com for CARB status on each part for a specific vehicle.



Motorcycle - Application Listing

CC	Model	Year	Air Filter	Air Filter Precharger	Custom	Custom Precharger	Oil Filter	Comments
KTM								
400	400 MXC	99-00					KN-157*	*Short Filter
400	400 MXC	01-02	KT-5201	KT-5201DK			KN-155*	*Tall Filter
400	400 MXC	01-02	KT-5201	KT-5201DK			KN-157*	*Short Filter
400	400 RXC	97-98					KN-155*	*Short Filter
400	400 RXC	97-98					KN-156*	*Tall Filter
400	400 SX	99					KN-155*	*Tall Filter
400	400 SX	99					KN-157*	*Short Filter
400	400 SX	00-02	KT-5201	KT-5201DK			KN-155*	*Tall Filter
400	400 SX	00-02	KT-5201	KT-5201DK			KN-157*	*Short Filter
400	400 XC-W	07	KT-5201	KT-5201DK			KN-155*	*Tall Filter
400	400 XC-W	07	KT-5201	KT-5201DK			KN-157*	*Short Filter
400	400 XC-W	08					KN-652	
400	400 XC-W	09-10	KT-4511XD	KT-4511DK			KN-652	
449	450 EXC	12-14	KT-4511XD	KT-4511DK			KN-655	
449	450 EXC	15	KT-4511XD	KT-4511DK				
449	450 EXC	16	KT-4511XD	KT-4511DK			KN-655	
449	450 EXC Six Days	12-14	KT-4511XD	KT-4511DK			KN-655	
449	450 EXC Six Days	15	KT-4511XD	KT-4511DK				
449	450 EXC Six Days	16	KT-4511XD	KT-4511DK			KN-655	
449	450 EXC-R	08-10	KT-4511XD	KT-4511DK			KN-652	
449	450 SMR	04-07	KT-5201	KT-5201DK			KN-155*	*Tall Filter
449	450 SMR	04-07	KT-5201	KT-5201DK			KN-157*	*Short Filter
449	450 SMR	08-11					KN-652	
449	450 SMR	12	KT-4511XD	KT-4511DK			KN-652	
449	450 SMR	14					KN-652	
449	450 SX-F	03	KT-5201	KT-5201DK			KN-155*	*Tall Filter
449	450 SX-F	03	KT-5201	KT-5201DK			KN-157*	*Short Filter
449	450 SX-F	07-12	KT-4511XD	KT-4511DK			KN-652	
449	450 SX-F	13-15					KN-655	
449	450 SX-F	16					KN-652	
449	450 SX-F Factory Edition	12	KT-4511XD	KT-4511DK			KN-652	
449	450 SX-F Factory Edition	13-14					KN-655	
449	450 SX-F Factory Edition	15-16					KN-652	
449	450 SXS	07-08	KT-4511XD	KT-4511DK			KN-652	
449	450 XC-F	08-09	KT-4511XD	KT-4511DK			KN-652	
449	450 XC-W	07	KT-5201	KT-5201DK			KN-155*	*Tall Filter
449	450 XC-W	07	KT-5201	KT-5201DK			KN-157*	*Short Filter
449	450 XC-W	08					KN-652	
449	450 XC-W	09-11	KT-4511XD	KT-4511DK			KN-652	
449	450 XC-W	12-16	KT-4511XD	KT-4511DK			KN-655	
450	450 EXC	03-05	KT-5201	KT-5201DK			KN-155*	*Tall Filter
450	450 EXC	03-05	KT-5201	KT-5201DK			KN-157*	*Short Filter
450	450 EXC	07	KT-5201	KT-5201DK			KN-155*	*Tall Filter
450	450 EXC	07	KT-5201	KT-5201DK			KN-157*	*Short Filter
450	450 EXC Racing	06					KN-155*	*Tall Filter
450	450 EXC Racing	06					KN-157*	*Short Filter
450	450 EXC Racing	07	KT-5201	KT-5201DK			KN-155*	*Tall Filter
450	450 EXC Racing	07	KT-5201	KT-5201DK			KN-157*	*Short Filter
450	450 EXC Six Days	10-11					KN-652	
450	450 EXC-G Racing	06	KT-5201	KT-5201DK			KN-155*	*Tall Filter
450	450 EXC-G Racing	06	KT-5201	KT-5201DK			KN-157*	*Short Filter
450	450 EXC-R	11					KN-652	
450	450 MXC	03-05	KT-5201	KT-5201DK			KN-155*	*Tall Filter
450	450 MXC	03-05	KT-5201	KT-5201DK			KN-157*	*Short Filter
450	450 MXC	06					KN-155*	*Tall Filter

2) Requires Two; 3) Requires Three; 4) Requires Four. The use of custom air filter requires removal of air box. Some custom filters and intakes are not legal for sale or use on any pollution controlled motor vehicle in California or states adopting California emission procedures. See knfilters.com for CARB status on each part for a specific vehicle.

Motorcycle - Application Listing



CC	Model	Year	Air Filter	Air Filter Precharger	Custom	Custom Precharger	Oil Filter	Comments
KTM								
450	450 MXC	06					KN-157*	*Short Filter
450	450 Rally	04					KN-155*	*Tall Filter
450	450 Rally	04					KN-156*	*Spin On
450	450 Rally	04					KN-157*	*Short Filter
450	450 SMS	04	KT-5201	KT-5201DK			KN-155*	*Tall Filter
450	450 SMS	04	KT-5201	KT-5201DK			KN-157*	*Short Filter
450	450 SX	06	KT-5201	KT-5201DK			KN-155*	*Tall Filter
450	450 SX	06	KT-5201	KT-5201DK			KN-157*	*Short Filter
450	450 SX Racing	02					KN-155*	*Tall Filter
450	450 SX Racing	02					KN-157*	*Short Filter
450	450 SX Racing	04-05	KT-5201	KT-5201DK			KN-155*	*Tall Filter
450	450 SX Racing	04-05	KT-5201	KT-5201DK			KN-157*	*Short Filter
450	450 SX Racing	06					KN-155*	*Tall Filter
450	450 SX Racing	06					KN-157*	*Short Filter
450	450 SXS	03-06	KT-5201	KT-5201DK			KN-155*	*Tall Filter
450	450 SXS	03-06	KT-5201	KT-5201DK			KN-157*	*Short Filter
450	450 XC	07	KT-5201	KT-5201DK			KN-155*	*Tall Filter
450	450 XC	07	KT-5201	KT-5201DK			KN-157*	*Short Filter
450	450 XC Cross Country	04	KT-5201	KT-5201DK			KN-155*	*Tall Filter
450	450 XC Cross Country	04	KT-5201	KT-5201DK			KN-157*	*Short Filter
450	450 XC-F	10					KN-652	
450	450 XC-F	13-15					KN-655	
450	450 XC-F	16					KN-652	
450	450 XC-G Racing	06	KT-5201	KT-5201DK			KN-155*	*Tall Filter
450	450 XC-G Racing	06	KT-5201	KT-5201DK			KN-157*	*Short Filter
478	505 XCF	08-09	KT-4511XD	KT-4511DK			KN-652	
505	505 SXF	08	KT-4511XD	KT-4511DK			KN-652	
505	505 SXF	09					KN-652	
505	505 SXF Preseries	07	KT-4511XD	KT-4511DK			KN-652	
510	500 EXC	12-16	KT-4511XD	KT-4511DK			KN-655	
510	500 EXC Six Days	12	KT-4511XD	KT-4511DK			KN-655	
510	500 EXC Six Days	16					KN-655	
510	500 XC-W	12-16	KT-4511XD	KT-4511DK			KN-655	
510	520 EXC Racing	99					KN-155*	*Tall Filter
510	520 EXC Racing	99					KN-157*	*Short Filter
510	520 EXC Racing	00-02	KT-5201	KT-5201DK			KN-155*	*Tall Filter
510	520 EXC Racing	00-02	KT-5201	KT-5201DK			KN-157*	*Short Filter
510	520 EXC-E	99					KN-155*	*Tall Filter
510	520 EXC-E	99					KN-157*	*Short Filter
510	520 MXC Racing	01-02	KT-5201	KT-5201DK			KN-155*	*Tall Filter
510	520 MXC Racing	01-02	KT-5201	KT-5201DK			KN-157*	*Short Filter
510	520 SX Racing	01-02	KT-5201	KT-5201DK			KN-155*	*Tall Filter
510	520 SX Racing	01-02	KT-5201	KT-5201DK			KN-157*	*Short Filter
520	520 MXC Racing	99-00					KN-155*	*Tall Filter
520	520 MXC Racing	99-00					KN-157*	*Short Filter
520	520 SX Racing	99					KN-155*	*Tall Filter
520	520 SX Racing	99					KN-157*	*Short Filter
520	520 SX Racing	00	KT-5201	KT-5201DK			KN-155*	*Tall Filter
520	520 SX Racing	00	KT-5201	KT-5201DK			KN-157*	*Short Filter
525	525 EXC	05	KT-5201	KT-5201DK			KN-155*	*Tall Filter
525	525 EXC	05	KT-5201	KT-5201DK			KN-157*	*Short Filter
525	525 EXC Racing	03-04	KT-5201	KT-5201DK			KN-155*	*Tall Filter
525	525 EXC Racing	03-04	KT-5201	KT-5201DK			KN-157*	*Short Filter
525	525 EXC Racing	06					KN-155*	*Tall Filter
525	525 EXC Racing	06					KN-157*	*Short Filter

2) Requires Two; 3) Requires Three; 4) Requires Four. The use of custom air filter requires removal of air box. Some custom filters and intakes are not legal for sale or use on any pollution controlled motor vehicle in California or states adopting California emission procedures. See knfilters.com for CARB status on each part for a specific vehicle.



Motorcycle - Application Listing

CC	Model	Year	Air Filter	Air Filter Precharger	Custom	Custom Precharger	Oil Filter	Comments
KTM								
525	525 EXC Racing	07	KT-5201	KT-5201DK			KN-155*	*Tall Filter
525	525 EXC Racing	07	KT-5201	KT-5201DK			KN-157*	*Short Filter
525	525 EXC-G Racing	03-04	KT-5201	KT-5201DK			KN-155*	*Tall Filter
525	525 EXC-G Racing	03-04	KT-5201	KT-5201DK			KN-157*	*Short Filter
525	525 EXC-G Racing	06-07	KT-5201	KT-5201DK			KN-155*	*Tall Filter
525	525 EXC-G Racing	06-07	KT-5201	KT-5201DK			KN-157*	*Short Filter
525	525 MXC	03-05	KT-5201	KT-5201DK			KN-155*	*Tall Filter
525	525 MXC	03-05	KT-5201	KT-5201DK			KN-157*	*Short Filter
525	525 MXC	06-07					KN-155*	*Tall Filter
525	525 MXC	06-07					KN-157*	*Short Filter
525	525 SMR	04-05	KT-5201	KT-5201DK			KN-155*	*Tall Filter
525	525 SMR	04-05	KT-5201	KT-5201DK			KN-157*	*Short Filter
525	525 SMR	06					KN-155*	*Tall Filter
525	525 SMR	06					KN-157*	*Short Filter
525	525 SX	04-06	KT-5201	KT-5201DK			KN-155*	*Tall Filter
525	525 SX	04-06	KT-5201	KT-5201DK			KN-157*	*Short Filter
525	525 SX Racing	03	KT-5201	KT-5201DK			KN-155*	*Tall Filter
525	525 SX Racing	03	KT-5201	KT-5201DK			KN-157*	*Short Filter
525	525 SX Racing	07					KN-155*	*Tall Filter
525	525 SX Racing	07					KN-157*	*Short Filter
525	525 XC	03-06					KN-155*	*Tall Filter
525	525 XC	03-06					KN-157*	*Short Filter
525	525 XC Desert Racing	07	KT-5201	KT-5201DK			KN-155*	*Tall Filter
525	525 XC Desert Racing	07	KT-5201	KT-5201DK			KN-157*	*Short Filter
525	525 XC-G Racing	06-07	KT-5201	KT-5201DK			KN-155*	*Tall Filter
525	525 XC-G Racing	06-07	KT-5201	KT-5201DK			KN-157*	*Short Filter
525	525 XC-W	03-06					KN-155*	*Tall Filter
525	525 XC-W	03-06					KN-157*	*Short Filter
525	525 XC-W	07	KT-5201	KT-5201DK			KN-155*	*Tall Filter
525	525 XC-W	07	KT-5201	KT-5201DK			KN-157*	*Short Filter
530	530 EXC-R	08-11	KT-4511XD	KT-4511DK			KN-652	
530	530 XC-W	08					KN-652	
530	530 XC-W	09-11	KT-4511XD	KT-4511DK			KN-652	
539	540 SXS Racing	01-04	KT-5201	KT-5201DK			KN-155*	*Tall Filter
539	540 SXS Racing	01-04	KT-5201	KT-5201DK			KN-157*	*Short Filter
540	540 SXS	06	KT-5201	KT-5201DK			KN-155*	*Tall Filter
540	540 SXS	06	KT-5201	KT-5201DK			KN-157*	*Short Filter
540	540 SXS Racing	05	KT-5201	KT-5201DK			KN-155*	*Tall Filter
540	540 SXS Racing	05	KT-5201	KT-5201DK			KN-157*	*Short Filter
560	560 SMR	06-07	KT-5201	KT-5201DK			KN-155*	*Tall Filter
560	560 SMR	06-07	KT-5201	KT-5201DK			KN-157*	*Short Filter
560	560 SMR	08					KN-155*	*Tall Filter
560	560 SMR	08					KN-157*	*Short Filter
609	620 Comp Limited	97					KN-155*	*Short Filter
609	620 Comp Limited	97					KN-156*	*Tall Filter
609	620 Duke	94					KN-155*	*Short Filter
609	620 Duke	94					KN-156*	*Tall Filter
609	620 Duke	96-97					KN-155*	*Short Filter
609	620 Duke	96-97					KN-156*	*Tall Filter
609	620 EXC	95					KN-155*	*Short Filter
609	620 EXC	95					KN-156*	*Tall Filter
609	620 LC4 EXC	97					KN-155*	*Short Filter
609	620 LC4 EXC	97					KN-156*	*Tall Filter
609	620 RXC	95					KN-155*	*Short Filter
609	620 RXC	95					KN-156*	*Tall Filter

2) Requires Two; 3) Requires Three; 4) Requires Four. The use of custom air filter requires removal of air box. Some custom filters and intakes are not legal for sale or use on any pollution controlled motor vehicle in California or states adopting California emission procedures. See knfilters.com for CARB status on each part for a specific vehicle.

Motorcycle - Application Listing



CC	Model	Year	Air Filter	Air Filter Precharger	Custom	Custom Precharger	Oil Filter	Comments
KTM								
609	620 RXC	97					KN-155*	*Short Filter
609	620 RXC	97					KN-156*	*Tall Filter
620	620 EGS	94-97					KN-155*	*Short Filter
620	620 EGS	94-97					KN-156*	*Tall Filter
620	620 EGS-E	97					KN-155*	*Short Filter
620	620 EGS-E	97					KN-156*	*Tall Filter
620	620 Enduro	97					KN-155*	*Short Filter
620	620 Enduro	97					KN-156*	*Tall Filter
620	620 LC4 SX	98					KN-155*	*Short Filter
620	620 LC4 SX	98					KN-156*	*Tall Filter
620	620 SC	99					KN-155*	*Short Filter
620	620 SC	99					KN-156*	*Tall Filter
625	625 SC	02					KN-155*	*Tall Filter
625	625 SC	02					KN-157*	*Short Filter
625	625 SC Supermoto	02					KN-155*	*Tall Filter
625	625 SC Supermoto	02					KN-157*	*Short Filter
625	625 SMC	04-06					KN-155*	*Short Filter
625	625 SMC	04-06					KN-156*	*Tall Filter
625	625 SXC	02-06					KN-155*	*Tall Filter
625	625 SXC	02-06					KN-157*	*Short Filter
625	625 SXC	07					KN-155*	*Short Filter
625	625 SXC	07					KN-157*	*Tall Filter
625	640 Adventure	98-04					KN-155*	*Short Filter
625	640 Adventure	98-04					KN-156*	*Tall Filter
625	640 Duke II	99-04					KN-155*	*Short Filter
625	640 Duke II	99-04					KN-156*	*Tall Filter
625	640 Duke-E	98					KN-155*	*Short Filter
625	640 Duke-E	98					KN-156*	*Tall Filter
625	640 Enduro	03-04					KN-155*	*Short Filter
625	640 Enduro	03-04					KN-156*	*Tall Filter
625	640 LC4	98-01					KN-155*	*Short Filter
625	640 LC4	98-01					KN-156*	*Tall Filter
625	640 LC4 Supermoto	01					KN-155*	*Short Filter
625	640 LC4 Supermoto	01					KN-156*	*Tall Filter
625	640 LC4-E	00-02					KN-155*	*Short Filter
625	640 LC4-E	00-02					KN-156*	*Tall Filter
625	640 LC4-E Six Days	00					KN-155*	*Short Filter
625	640 LC4-E Six Days	00					KN-156*	*Tall Filter
625	640 LC4-E Supermoto	01					KN-155*	*Short Filter
625	640 LC4-E Supermoto	01					KN-156*	*Tall Filter
625	640 LC-E	00					KN-155*	*Short Filter
625	640 LC-E	00					KN-156*	*Tall Filter
625	640 Supermoto	99-00					KN-155*	*Short Filter
625	640 Supermoto	99-00					KN-156*	*Tall Filter
625	640 Supermoto	02-04					KN-155*	*Short Filter
625	640 Supermoto	02-04					KN-156*	*Tall Filter
640	640 Adventure	05-08					KN-155*	*Short Filter
640	640 Adventure	05-08					KN-156*	*Tall Filter
640	640 Duke II	05-06					KN-155*	*Short Filter
640	640 Duke II	05-06					KN-156*	*Tall Filter
640	640 Enduro	05					KN-155*	*Short Filter
640	640 Enduro	05					KN-156*	*Tall Filter
640	640 LC4	97					KN-155*	*Short Filter
640	640 LC4	97					KN-156*	*Tall Filter
640	640 Supermoto	05					KN-155*	*Short Filter

2) Requires Two; 3) Requires Three; 4) Requires Four. The use of custom air filter requires removal of air box. Some custom filters and intakes are not legal for sale or use on any pollution controlled motor vehicle in California or states adopting California emission procedures. See knfilters.com for CARB status on each part for a specific vehicle.



Motorcycle - Application Listing

CC	Model	Year	Air Filter	Air Filter Precharger	Custom	Custom Precharger	Oil Filter	Comments
KTM								
640	640 Supermoto	05					KN-156*	*Tall Filter
650	650 LC4 Supermoto	06					KN-155*	*Tall Filter
650	650 LC4 Supermoto	06					KN-157*	*Short Filter
660	660 LC4 Rally	97					KN-155*	*Short Filter
660	660 LC4 Rally	97					KN-156*	*Tall Filter
660	660 Rally	01-02					KN-155*	*Tall Filter
660	660 Rally	01-02					KN-156*	*Spin On
660	660 Rally	01-02					KN-157*	*Short Filter
660	660 Rally	03					KN-155*	*Short Filter
660	660 Rally	03					KN-156*	*Tall Filter
660	660 Rally	04-06					KN-155*	*Tall Filter
660	660 Rally	04-06					KN-156*	*Spin On
660	660 Rally	04-07					KN-157*	*Short Filter
660	660 Rally	07					KN-155*	*Gearbox Filter
660	660 Rally	07					KN-156*	*Tall Filter
660	660 SMC	03-05					KN-155*	*Tall Filter
660	660 SMC	03-05					KN-157*	*Short Filter
660	660 SMS	04					KN-155*	*Tall Filter
660	660 SMS	04					KN-157*	*Short Filter
660	660 Supermoto Factory Replica	02-03					KN-155*	*Tall Filter
660	660 Supermoto Factory Replica	02-03					KN-157*	*Short Filter
690	690 Duke	08-11	KT-6907				KN-155*	*Tall Filter
690	690 Duke	08-11	KT-6907				KN-157*	*Short Filter
690	690 Duke	12	KT-6912				KN-155*	*Short Filter
690	690 Duke	13-17	KT-6912				KN-155*	*Tall Filter
690	690 Duke	13-17	KT-6912				KN-651*	*Short Filter
690	690 Enduro	08	KT-6908				KN-155*	*Tall Filter
690	690 Enduro	08	KT-6908				KN-157*	*Short Filter
690	690 Enduro R	09-11	KT-6908				KN-157*	*Short Filter
690	690 Enduro R	09-16	KT-6908				KN-155*	*Tall Filter
690	690 Enduro R	12-16	KT-6908				KN-651*	*Short Filter
690	690 SMC	08-11	KT-6908				KN-155*	*Tall Filter
690	690 SMC	08-11	KT-6908				KN-157*	*Short Filter
690	690 SMC	12	KT-6908				KN-155*	*Short Filter
690	690 SMC	13-16	KT-6908					
690	690 Supermoto	07	KT-6907				KN-655*	*Tall Filter
690	690 Supermoto	07-08	KT-6907				KN-157*	*Short Filter
690	690 Supermoto	08	KT-6907				KN-155*	*Tall Filter
690	Duke R	13	KT-6912				KN-155*	*Short Filter
690	Duke R	14-15	KT-6912				KN-155	
690	Duke R	16-17	KT-6912					
942	950 Adventure	02					KN-158	
942	950 Adventure	03-06	KT-9504				KN-158	
942	950 Adventure S	03-06	KT-9504				KN-158	
942	950 Super Enduro R	06	KT-9504					
942	950 Super Enduro R	07-09	KT-9504				KN-158	
942	950 Supermoto	06-08	KT-9504				KN-158	
942	950 Supermoto R	07	KT-9504				KN-158	
942	950 Supermoto R	08	KT-9504					
950	950 Super Enduro R	11					KN-158	
950	950 Supermoto	05					KN-158	
999	990 Adventure	07-13	KT-9907				KN-158	
999	990 Adventure	14					KN-158	
999	990 Adventure Dakar Edition	11	KT-9907				KN-158	
999	990 Adventure R	09-12	KT-9907				KN-158	

2) Requires Two; 3) Requires Three; 4) Requires Four. The use of custom air filter requires removal of air box. Some custom filters and intakes are not legal for sale or use on any pollution controlled motor vehicle in California or states adopting California emission procedures. See knfilters.com for CARB status on each part for a specific vehicle.

Motorcycle - Application Listing



CC	Model	Year	Air Filter	Air Filter Precharger	Custom	Custom Precharger	Oil Filter	Comments
KTM								
999	990 Adventure S	07-08	KT-9907					
999	990 SMR	10					KN-158	
999	990 SMT	10-13	KT-9907				KN-158	
999	990 Super Duke	05-06					KN-158	
999	990 Super Duke	07-08	KT-9907				KN-158	
999	990 Super Duke	09-11					KN-158	
999	990 Super Duke R	08-11					KN-158	
999	990 Supermoto	10-11	KT-9907				KN-158	
999	990 Supermoto R	10-11	KT-9907				KN-158	
999	990 Supermoto T	10-11	KT-9907				KN-158	
999	990 Supermoto T	13	KT-9907				KN-158	
1050	1050 Adventure	15-16	KT-1113					
1150	1190 RC8	08-09	KT-1108				KN-158	
1190	1190 Adventure	15	KT-1113				KN-158	
1190	1190 Adventure	16	KT-1113					
1190	1190 RC8	10-11	KT-1108				KN-158	
1190	1190 RC8R	10					KN-158	
1190	1190 RC8R	11-14	KT-1108				KN-158	
1190	1190 RC8R	15					KN-158	
1190	RC8R	14					KN-158	
1195	1190 Adventure	13-14	KT-1113				KN-158	
1195	1190 Adventure R	13-15	KT-1113				KN-158	
1195	1190 Adventure R	16	KT-1113					
1290	1290 Super Duke R	15-16	KT-1113				KN-158	
1301	1290 Super Adventure	15-16					KN-158	
1301	1290 Super Duke R	13	KT-1113					
1301	1290 Super Duke R	14	KT-1113				KN-158	
1301	1290 Super Duke R Special Ed.	16	KT-1113				KN-158	
MOTO GUZZI								
850	850	76	MG-0200					
850	Breva 850	06-07	AL-1001					
949	V1000 California III	90-93	MG-0001					
949	V1000 California III LAPD	93	MG-0001					
1000	Daytona 1000	93-97	CG-9002					
1000	V10 Centauro GT	98	CG-9002					
1000	V10 Centauro Sport	98	CG-9002					
1000	V1000 California II	83-86	MG-0001					
1000	V1000 California III	89	MG-0001					
1000	V1000 California III Classic	94	MG-0001					
1000	V1000 California III LAPD	94	MG-0001					
1000	V1000 G5	81-83	MG-2640					
1000	V1000 LeMans III	83	MG-0001					
1000	V1000 LeMans III	85-88	MG-0001					
1064	California 1100	94-97	CG-9002					
1064	Sport 1100	94-97	CG-9002					
1100	Breva 1100	05-08	AL-1001					
1100	Breva 1200 Sport	08	AL-1001					
1100	California Vintage	06-07	CG-9002					
1200	Norge 1200	07-08	AL-1001					
1200	Stelvio 1200 NTX	15					KN-151	
MV AGUSTA								
1078	Brutale 1078RR	09					KN-204*	*Chrome=KN-204C
1078	F4 R 312	08					KN-204*	*Chrome=KN-204C
1078	F4 RR 312 1078	09					KN-204*	*Chrome=KN-204C

2) Requires Two; 3) Requires Three; 4) Requires Four. The use of custom air filter requires removal of air box. Some custom filters and intakes are not legal for sale or use on any pollution controlled motor vehicle in California or states adopting California emission procedures. See knfilters.com for CARB status on each part for a specific vehicle.



Motorcycle - Application Listing

CC	Model	Year	Air Filter	Air Filter Precharger	Custom	Custom Precharger	Oil Filter	Comments
NORTON								
750	Commando 750	68-74	NO-0100*		R-0990**			*no elect. start/ **no elect. start
850	Commando 850	74	NO-0100*		R-0990**			*no elect. start/ **no elect. start
POLARIS								
2384	Slingshot	15-16	PL-2415					
2384	Slingshot SL	15-16	PL-2415					
2384	Slingshot SL LE	15-16	PL-2415					
SUZUKI								
60	RM60	03	KA-6085					
65	RM65	04-05	KA-8088	22-8088PK				
79	RM80	90-01	SU-8086					
80	RM80	86-89	SU-8086					
85	RM85	02-10	SU-8086					
85	RM85	12-13	SU-8086					
85	RM85L	03-10	SU-8086					
85	RM85L	12-13	SU-8086					
100	DR100	83-89					KN-131	
100	RM100	03	KA-8088	22-8088PK				
100	SP100	83					KN-131	
101	DR100	90					KN-131	
110	DRZ110	03-05	KA-1102				KN-112	
124	DRZ125L	10	KA-1203				KN-132	
124	DRZ125L	12-16	KA-1203				KN-132	
125	CS125 Roadie	83-87					KN-131	
125	DR125	82-85					KN-131	
125	DR125	86-88					KN-132	
125	DR125	97					KN-132	
125	DR125 S	80-84					KN-131	
125	DR125SE	98-00					KN-132	
125	DR125SE Raider	85-96					KN-132	
125	DR125SM	07-09					KN-131	
125	DR125X	98-00					KN-132	
125	DR125Y	98-00					KN-132	
125	DRZ125	03-10	KA-1203				KN-132	
125	DRZ125	12-14	KA-1203				KN-132	
125	DRZ125L	03-09	KA-1203				KN-132	
125	GN125E	82-83					KN-131	
125	GN125E	91-00					KN-131	
125	GS125	79-82					KN-131*	*Drum Brake
125	GS125	83-00					KN-131*	*Disc Brake
125	GZ125 Marauder	99-10					KN-131	
125	RM125	96-00	SU-2596					
125	RM125	06-08	YA-2506XD	YA-4098-1DK				
125	RV125 Van Van	03-12					KN-132	
125	SP125	82-83					KN-131	
125	SP125	86-88					KN-132	
125	TU125XT	99					KN-131	
125	UC125 Epicuro	99-03					KN-131	
125	UX125 Sixteen	08-12					KN-131	
125	VL125LC Intruder	00-06					KN-136	
150	UC150 Epicuro	99-03					KN-131	
150	UX150 Sixteen	08-12					KN-131	
199	DR200S	15-16					KN-132	
200	DR200	86-88					KN-132	
200	DR200S	86-91					KN-132	
200	DR200SE	96-10					KN-132	

2) Requires Two; 3) Requires Three; 4) Requires Four. The use of custom air filter requires removal of air box. Some custom filters and intakes are not legal for sale or use on any pollution controlled motor vehicle in California or states adopting California emission procedures. See knfilters.com for CARB status on each part for a specific vehicle.

Motorcycle - Application Listing



CC	Model	Year	Air Filter	Air Filter Precharger	Custom	Custom Precharger	Oil Filter	Comments
SUZUKI								
200	SP200	86-88					KN-132	
248	GW250	13	SU-2513				KN-138*	*Chrome=KN-138C
248	GW250	14	SU-2513					
248	GW250	15	SU-2513				KN-138*	*Chrome=KN-138C
248	GW250F	15	SU-2513				KN-138*	*Chrome=KN-138C
249	RMZ250	10-16	YA-2506XD	YA-4098-1DK			KN-207	
249	TU250X	09-15	SU-2497				KN-136	
249	TU250X	16	SU-2497				KN-207	
250	DR250	82-83					KN-136	
250	DR250	85					KN-136	
250	DR250S	82-88					KN-136	
250	DR250S	90-93	SU-3590				KN-136	
250	DR250S	94-96					KN-136	
250	DR250SE	93-95	SU-3590				KN-136	
250	DR250SE Off Road	97-99					KN-136	
250	DRZ250	01-07	SU-2501				KN-136	
250	FL125 SDW Address	07-09					KN-207	
250	GN250	82-00					KN-136	
250	GS250	79-81					KN-133	
250	GSF250	92-95					KN-531	
250	GSF250	97					KN-531	
250	GSX250	80-82					KN-133	
250	GSX250	86					KN-531	
250	GSX250	91					KN-531	
250	GSX250 Katana	82-84					KN-133	
250	GSX250S Cobra	89					KN-531	
250	GSXR250	87-89					KN-133	
250	GZ250 Marauder	99-10					KN-136	
250	RM250	99-04	SU-2596					
250	RM250	06-08	YA-2506XD	YA-4098-1DK				
250	RMZ250	04-06	KA-2504				KN-207	
250	RMZ250	07-09	YA-2506XD	YA-4098-1DK			KN-207	
250	SP250	82-85					KN-136	
250	TU250X	98-00					KN-136	
250	VL250LC Intruder	00-04					KN-136	
300	GS300L	82-85					KN-133	
350	DR350	90-99	SU-3590				KN-136	
350	DR350	00					KN-136	
350	DR350 Off Road	90-93					KN-136	
350	DR350 Off Road	97-98					KN-136	
350	DR350S	90-96	SU-3590				KN-136	
350	DR350SE	97-99	SU-3590				KN-136	
350	DR350SE	00					KN-136	
350	SG350	91-92					KN-136	
380	GT380 Sebring	74-77				RC-1070 ³	22-8028PK	
398	DRZ400	00-04	SU-4000	SU-4000PK			KN-139	
398	DRZ400E	00-08	SU-4000	SU-4000PK			KN-139	
398	DRZ400S	00-13	SU-4000	SU-4000PK			KN-139	
398	DRZ400S	14	SU-4000	SU-4000PK				
398	DRZ400S	15-16	SU-4000	SU-4000PK			KN-139	
398	DRZ400SM	05-10	SU-4000	SU-4000PK			KN-139	
398	DRZ400SM	13	SU-4000	SU-4000PK			KN-139	
398	DRZ400SM	14	SU-4000	SU-4000PK				
398	DRZ400SM	15-16	SU-4000	SU-4000PK			KN-139	
399	GSF400 Bandit	90-95					KN-133	

2) Requires Two; 3) Requires Three; 4) Requires Four. The use of custom air filter requires removal of air box. Some custom filters and intakes are not legal for sale or use on any pollution controlled motor vehicle in California or states adopting California emission procedures. See knfilters.com for CARB status on each part for a specific vehicle.



Motorcycle - Application Listing

CC	Model	Year	Air Filter	Air Filter Precharger	Custom	Custom Precharger	Oil Filter	Comments
SUZUKI								
399	GSXR400	90-92					KN-138*	*Chrome=KN-138C
400	DR400	82-83					KN-136	
400	DR400S	80-81					KN-136	
400	GN400	80-82					KN-136	
400	GS400	77-78			RC-0982*	RC-1820DK	KN-133	*Inc. 2 Filters
400	GS400	79					KN-133	
400	GS400	93					KN-133	
400	GSX400	80-90					KN-133	
400	GSX400 X Impulse	86					KN-133	
400	GSXR400	85-89					KN-133	
400	SP400T	79-82					KN-136	
425	GS425	79			RC-0982*	RC-1820DK	KN-133	*Inc. 2 Filters
425	GS425E	80			RC-0982*	RC-1820DK	KN-133	*Inc. 2 Filters
449	RMZ450	10-16	YA-2506XD	YA-4098-1DK			KN-207	
450	GS450E	80-82			RC-1822*	RC-1820DK	KN-133	*Inc. 2 Filters
450	GS450E	83			RC-0982*	RC-1820DK	KN-133	*Inc. 2 Filters
450	GS450E	84-88					KN-133	
450	GS450GA	82			RC-1822*	RC-1820DK	KN-133	*Inc. 2 Filters
450	GS450GA	83			RC-0982*	RC-1820DK	KN-133	*Inc. 2 Filters
450	GS450GA	84					KN-133	
450	GS450GA	85			RC-0982*	RC-1820DK	KN-133	*Inc. 2 Filters
450	GS450L	80-82			RC-1822*	RC-1820DK	KN-133	*Inc. 2 Filters
450	GS450L	83			RC-0982*	RC-1820DK	KN-133	*Inc. 2 Filters
450	GS450L	84					KN-133	
450	GS450L	85-88			RC-0982*	RC-1820DK	KN-133	*Inc. 2 Filters
450	GS450S	80-81			RC-1822*	RC-1820DK	KN-133	*Inc. 2 Filters
450	GS450S	82-83					KN-133	
450	GS450T	80					KN-133	
450	GS450T	81-82			RC-1822*	RC-1820DK	KN-133	*Inc. 2 Filters
450	GS450T	83					KN-133	
450	GS450TX	82			RC-1822*	RC-1820DK	KN-133	*Inc. 2 Filters
450	GS450TX	83			RC-0982*	RC-1820DK	KN-133	*Inc. 2 Filters
450	RMX450Z	10-12					KN-207	
450	RMZ450	05-09	YA-2506XD	YA-4098-1DK			KN-207	
500	DR500	81-84					KN-137	
500	DR500 Off Road	83-84					KN-137	
500	GS500	01-02	SU-5589		RU-2970		KN-133	
500	GS500	03-07	SU-5589				KN-133	
500	GS500E	88					KN-133	
500	GS500E	89-00	SU-5589		RU-2970		KN-133	
500	GS500F	04-09	SU-5589				KN-133	
500	GS500F	10					KN-133	
500	GS500H	07-09					KN-133	
500	SP500	81-83					KN-137	
550	GS550	77-79	SU-5500		RC-2314*	22-8028PK	KN-133	*Inc. 4 Filters
550	GS550 Katana	81					KN-133	
550	GS550 Katana	82	SU-5500		RC-2382*		KN-133	*Inc. 2 Filters
550	GS550D	78-80					KN-133	
550	GS550E	78-79	SU-5500		RC-2314*	22-8028PK	KN-133	*Inc. 4 Filters
550	GS550E	80	SU-5500		RC-2382*		KN-133	*Inc. 2 Filters
550	GS550E	81-82					KN-133	
550	GS550E	83	SU-5503				KN-133	
550	GS550E	85	SU-5503				KN-133	
550	GS550ES	83-86	SU-5503				KN-133	
550	GS550ES3	83	SU-5503				KN-133	

2) Requires Two; 3) Requires Three; 4) Requires Four. The use of custom air filter requires removal of air box. Some custom filters and intakes are not legal for sale or use on any pollution controlled motor vehicle in California or states adopting California emission procedures. See knfilters.com for CARB status on each part for a specific vehicle.

Motorcycle - Application Listing



CC	Model	Year	Air Filter	Air Filter Precharger	Custom	Custom Precharger	Oil Filter	Comments
SUZUKI								
550	GS550L	79	SU-5500		RC-2314*	22-8028PK	KN-133	*Inc. 4 Filters
550	GS550L	80	SU-5500		RC-2382*		KN-133	*Inc. 2 Filters
550	GS550L	81	SU-5500				KN-133	
550	GS550L	82	SU-5500		RC-2382*		KN-133	*Inc. 2 Filters
550	GS550L	83	SU-5503				KN-133	
550	GS550L	85-86	SU-5503				KN-133	
550	GS550M	82	SU-5500		RC-2382*		KN-133	*Inc. 2 Filters
550	GS550T	81	SU-5500		RC-2382*		KN-133	*Inc. 2 Filters
550	GSX550	83-87					KN-133	
550	GT550 Indy	74-77			RC-1070 ³	22-8028PK		
580	RF600R	93					KN-138*	*Chrome=KN-138C
580	RF600R	94-98	SU-9094				KN-138*	*Chrome=KN-138C
599	VS600GL Intruder	95-97					KN-138*	*Chrome=KN-138C
600	DR600	85-91					KN-137	
600	DR600R/L/M	90-91					KN-137	
600	DR600RSE/M	91					KN-137	
600	GSF600 Bandit	95					KN-138*	*Chrome=KN-138C
600	GSF600 Bandit	96-99	SU-7593				KN-138*	*Chrome=KN-138C
600	GSF600 Bandit	00-03	SU-6000				KN-138*	*Chrome=KN-138C
600	GSF600 Bandit	04					KN-138*	*Chrome=KN-138C
600	GSF600 Bandit S	95					KN-138*	*Chrome=KN-138C
600	GSF600 Bandit S	96-99	SU-7593				KN-138*	*Chrome=KN-138C
600	GSF600 Bandit S	00-04	SU-6000				KN-138*	*Chrome=KN-138C
600	GSR600	06-10	SU-6006				KN-138*	*Chrome=KN-138C
600	GSR600	11	SU-6006				KN-138*	*Chrome=KN-138C
600	GSX600F Katana	88-89	SU-7592		RC-1824*	RC-1820DK	KN-138**	*Inc. 4 Filters/ **Chrome=KN-138C
600	GSX600F Katana	90-03	SU-7592		RU-2922*		KN-138**	*Inc. 2 Filters/ **Chrome=KN-138C
600	GSX600F Katana	04-06	SU-7592				KN-138*	*Chrome=KN-138C
600	GSXR600	97-00	SU-7596				KN-138*	*Chrome=KN-138C
600	GSXR600	01-03	SU-7500				KN-138*	*Chrome=KN-138C
600	GSXR600	04-05	SU-7504				KN-138*	*Chrome=KN-138C
600	GSXR600	06-10	SU-7506				KN-138*	*Chrome=KN-138C
600	GSXR600	06-10	SU-7506R*				KN-138**	*Race Specific/ **Chrome=KN-138C
600	GSXR600	11-16	SU-7511				KN-138*	*Chrome=KN-138C
600	GSXR600	11-16	SU-7511R*				KN-138**	*Race Specific/ **Chrome=KN-138C
600	GSXR600W	92-93	SU-7593				KN-138*	*Chrome=KN-138C
600	SP600	85					KN-137	
600	VS600 GLF	98					KN-138*	*Chrome=KN-138C
644	DR650S	15-16	SU-6596	SU-6596DK			KN-137	
644	DR650SE	10-14	SU-6596	SU-6596DK			KN-137	
645	DL650 V-Strom	04-12	SU-1002				KN-138*	*Chrome=KN-138C
645	DL650A V-Strom ABS	07-09	SU-1002				KN-138*	*Chrome=KN-138C
645	DL650A V-Strom ABS	11-13	SU-1002				KN-138*	*Chrome=KN-138C
645	DL650A V-Strom ABS	14	SU-1002				KN-138*	*Chrome=KN-138C
645	DL650A V-Strom ABS	15-16	SU-1002				KN-138*	*Chrome=KN-138C
645	DL650A V-Strom ABS Adventure	12-13	SU-1002				KN-138*	*Chrome=KN-138C
645	DL650A V-Strom ABS Adventure	14	SU-1002				KN-138*	*Chrome=KN-138C
645	DL650A V-Strom ABS Adventure	15	SU-1002				KN-138*	*Chrome=KN-138C
645	DL650A V-Strom XT ABS	15-16	SU-1002				KN-138*	*Chrome=KN-138C
645	SFV650	13-14	SU-6509				KN-138*	*Chrome=KN-138C
645	SFV650	15	SU-6509				KN-138*	*Chrome=KN-138C
645	SV650	15	SU-6509				KN-138*	*Chrome=KN-138C
645	SV650	16	SU-6509				KN-207	

2) Requires Two; 3) Requires Three; 4) Requires Four. The use of custom air filter requires removal of air box. Some custom filters and intakes are not legal for sale or use on any pollution controlled motor vehicle in California or states adopting California emission procedures. See knfilters.com for CARB status on each part for a specific vehicle.



Motorcycle - Application Listing

CC	Model	Year	Air Filter	Air Filter Precharger	Custom	Custom Precharger	Oil Filter	Comments
SUZUKI								
650	Boulevard S40	05-09	SU-6595				KN-137	
650	DR650S	90-95	SU-6590	SU-6590PY			KN-137	
650	DR650SE	96-09	SU-6596	SU-6596DK			KN-137	
650	DS650	92-93					KN-137	
650	GR650	83-85					KN-133	
650	GR650 Tempter	83					KN-133	
650	GR650X Tempter	83					KN-133	
650	GS650E	81-82	SU-5500		RC-2382*		KN-133	*Inc. 2 Filters
650	GS650G	81-84					KN-133	
650	GS650GL	81-84					KN-133	
650	GS650M Katana	83					KN-133	
650	GSF650 Bandit	05-10	SU-6505				KN-138*	*Chrome=KN-138C
650	GSF650 Bandit	11-12					KN-138*	*Chrome=KN-138C
650	GSF650 Bandit S	05-09	SU-6505				KN-138*	*Chrome=KN-138C
650	G SX650F	08-09	SU-6505				KN-138*	*Chrome=KN-138C
650	LS650 Boulevard	05-11					KN-137	
650	LS650 Savage	86-09	SU-6595				KN-137	
650	LS650 Savage	10-15	SU-6595					
650	SV650	99-02	SU-6599				KN-138*	*Chrome=KN-138C
650	SV650	03-09	SU-6503				KN-138*	*Chrome=KN-138C
650	SV650 SA	10					KN-138*	*Chrome=KN-138C
650	SV650A ABS	07	SU-6503					
650	SV650S	99-02	SU-6599				KN-138*	*Chrome=KN-138C
650	SV650S	03-09	SU-6503				KN-138*	*Chrome=KN-138C
650	SV650S	10					KN-138*	*Chrome=KN-138C
650	SV650SF	09	SU-6503				KN-138*	*Chrome=KN-138C
650	XF650 Freewind	97-02					KN-137	
650	XN85 D Turbo	83-86					KN-133	
652	Boulevard S40	11-14	SU-6595					
652	Boulevard S40	15	SU-6595				KN-137	
652	Boulevard S40	16	SU-6595					
652	SFV650	09-12	SU-6509				KN-138*	*Chrome=KN-138C
656	G SX650F	10-13	SU-6505				KN-138*	*Chrome=KN-138C
700	GS700	85	SU-7503		RC-0984*	RC-1820DK	KN-133	*Inc. 4 Filters
700	GS700	86	SU-7503		RC-0984*	RC-1820DK		*Inc. 4 Filters
700	GS700E	85	SU-7503		RC-0984*	RC-1820DK		*Inc. 4 Filters
700	GS700ES	85	SU-7503		RC-0984*	RC-1820DK		*Inc. 4 Filters
700	GV700 Madura	85	SU-5589				KN-134	
700	GV700 Madura	86					KN-134	
700	VS700 Intruder	86	SU-7086				KN-134	
700	VS700 Intruder	87	SU-7086				KN-138*	*Chrome=KN-138C
700	VS700 Intruder	88					KN-138*	*Chrome=KN-138C
749	GSXS750	15-16	SU-6006				KN-138*	*Chrome=KN-138C
749	GSXS750Z	15	SU-6006				KN-138*	*Chrome=KN-138C
750	DR750	88-89					KN-137	
750	GS750	77-79	SU-1200		RC-2454*	RC-1820DK	KN-133	*Inc. 4 Filters
750	GS750	80-82	SU-1250		RC-0984*	RC-1820DK	KN-133	*Inc. 4 Filters
750	GS750	84-85	SU-1250		RC-0984*	RC-1820DK	KN-133	*Inc. 4 Filters
750	GS750E	83	SU-7503		RC-0984*	RC-1820DK	KN-133	*Inc. 4 Filters
750	GS750ES	83	SU-7503		RC-0984*	RC-1820DK	KN-133	*Inc. 4 Filters
750	GS750S Katana	83	SU-1250		RC-0984*	RC-1820DK	KN-133	*Inc. 4 Filters
750	GSR750	11-16	SU-6006				KN-138*	*Chrome=KN-138C
750	G SX750	79					KN-133	
750	G SX750	80-85	SU-1250				KN-133	
750	G SX750	86-89					KN-133	

2) Requires Two; 3) Requires Three; 4) Requires Four. The use of custom air filter requires removal of air box. Some custom filters and intakes are not legal for sale or use on any pollution controlled motor vehicle in California or states adopting California emission procedures. See knfilters.com for CARB status on each part for a specific vehicle.

Motorcycle - Application Listing



CC	Model	Year	Air Filter	Air Filter Precharger	Custom	Custom Precharger	Oil Filter	Comments
SUZUKI								
750	GSX750	01-02					KN-137	
750	GSX750 Katana	84-86					KN-133	
750	GSX750 Retro	98-99	SU-5589				KN-138*	*Chrome=KN-138C
750	GSX750 Retro	00-02					KN-138*	*Chrome=KN-138C
750	GSX750F Katana	89-02	SU-7592		RU-2922*		KN-138**	*Inc. 2 Filters/ **Chrome=KN-138C
750	GSX750F Katana	03-06	SU-7592				KN-138*	*Chrome=KN-138C
750	GSXR750	86-87			RC-1824*	RC-1820DK	KN-134	*Inc. 4 Filters
750	GSXR750	88-92	SU-7588		RU-2922*		KN-138**	*Inc. 2 Filters/ **Chrome=KN-138C
750	GSXR750	96-99	SU-7596				KN-138*	*Chrome=KN-138C
750	GSXR750	00-03	SU-7500				KN-138*	*Chrome=KN-138C
750	GSXR750	04-05	SU-7504				KN-138*	*Chrome=KN-138C
750	GSXR750	06-10	SU-7506				KN-138*	*Chrome=KN-138C
750	GSXR750	06-10	SU-7506R*				KN-138**	*Race Specific/ **Chrome=KN-138C
750	GSXR750	11-16	SU-7511				KN-138*	*Chrome=KN-138C
750	GSXR750	11-16	SU-7511R*				KN-138**	*Race Specific/ **Chrome=KN-138C
750	GSXR750 50th Ann. Edition	14	SU-7511				KN-138*	*Chrome=KN-138C
750	GSXR750 50th Ann. Edition	14	SU-7511R*				KN-138**	*Race Specific/ **Chrome=KN-138C
750	GSXR750 Sling Shot	88-91					KN-138*	*Chrome=KN-138C
750	GSXR750F	85-87					KN-134	
750	GSXR750G	85-87					KN-134	
750	GSXR750H	85-87					KN-134	
750	GSXR750HG	85-87					KN-134	
750	GSXR750R	86			RC-1824*	RC-1820DK	KN-134	*Inc. 4 Filters
750	GSXR750R	87					KN-134	
750	GSXR750W	93-95	SU-7593				KN-138*	*Chrome=KN-138C
750	GSXR750XH	85-87					KN-134	
750	GT750 LeMans	73-77			RC-0500 ³	RU-0500PK		
750	VS750	85-86					KN-134	
750	VS750 Intruder	87					KN-138*	*Chrome=KN-138C
750	VS750 Intruder	88-91	SU-7086				KN-138*	*Chrome=KN-138C
778	DR800	90-94					KN-137	
778	DR800	95-97	SU-0006				KN-137	
778	DR800	98-99					KN-137	
800	Boulevard S50	05-09	SU-7086				KN-138*	*Chrome=KN-138C
800	DR800	88-89					KN-137	
800	DR800	00					KN-137	
800	M800 Intruder	05-09					KN-138*	*Chrome=KN-138C
800	M800 Intruder	11					KN-138*	*Chrome=KN-138C
800	VL800LC Intruder Volusia	01-04	SU-8001				KN-138*	*Chrome=KN-138C
800	VS800 Intruder	92-04	SU-7086				KN-138*	*Chrome=KN-138C
800	VS800 Intruder	05-09					KN-138*	*Chrome=KN-138C
800	VX800	97					KN-138*	*Chrome=KN-138C
800	VZ800 Intruder M800	05-08	SU-8005				KN-138*	*Chrome=KN-138C
800	VZ800 Intruder M800	09	SU-8009				KN-138*	*Chrome=KN-138C
800	VZ800 Marauder	97-04	SU-5589*				KN-138**	*Jet kit required, purchase separately/ **Chrome=KN-138C
800	VZ800 Marauder	05-06	SU-8005					
800	VZ800 Marauder	07-08	SU-8005				KN-138*	*Chrome=KN-138C
801	VX800	90-96					KN-138*	*Chrome=KN-138C
805	Boulevard C50	05-08	SU-8001				KN-138*	*Chrome=KN-138C
805	Boulevard C50	09-13	SU-8009				KN-138*	*Chrome=KN-138C

2) Requires Two; 3) Requires Three; 4) Requires Four. The use of custom air filter requires removal of air box. Some custom filters and intakes are not legal for sale or use on any pollution controlled motor vehicle in California or states adopting California emission procedures. See knfilters.com for CARB status on each part for a specific vehicle.



Motorcycle - Application Listing

CC	Model	Year	Air Filter	Air Filter Precharger	Custom	Custom Precharger	Oil Filter	Comments
SUZUKI								
805	Boulevard C50	15	SU-8009				KN-138*	*Chrome=KN-138C
805	Boulevard C50 Black	05-07	SU-8001				KN-138*	*Chrome=KN-138C
805	Boulevard C50 BOSS	14	SU-8009				KN-138*	*Chrome=KN-138C
805	Boulevard C50 Custom Volusia	08					KN-138*	*Chrome=KN-138C
805	Boulevard C50 Limited Edition	07-08	SU-8001				KN-138*	*Chrome=KN-138C
805	Boulevard C50 Special Edition	09	SU-8009				KN-138*	*Chrome=KN-138C
805	Boulevard C50 Special Edition	13	SU-8009				KN-138*	*Chrome=KN-138C
805	Boulevard C50 Volusia	07-08					KN-138*	*Chrome=KN-138C
805	Boulevard C50T	05-08	SU-8001				KN-138*	*Chrome=KN-138C
805	Boulevard C50T	09	SU-8009				KN-138*	*Chrome=KN-138C
805	Boulevard C50T	14-15	SU-8009				KN-138*	*Chrome=KN-138C
805	Boulevard M50	05-08	SU-8005				KN-138*	*Chrome=KN-138C
805	Boulevard M50	09-12	SU-8009				KN-138*	*Chrome=KN-138C
805	Boulevard M50	13	SU-8009					
805	Boulevard M50	15					KN-138*	*Chrome=KN-138C
805	Boulevard M50 Black	05-06	SU-8005				KN-138*	*Chrome=KN-138C
805	Boulevard M50 Limited	07	SU-8005				KN-138*	*Chrome=KN-138C
805	Boulevard M50 Special Edition	09					KN-138*	*Chrome=KN-138C
805	VL800 Intruder C800	05-06					KN-138*	*Chrome=KN-138C
805	VL800 Intruder C800	07-08	SU-8001				KN-138*	*Chrome=KN-138C
805	VL800 Intruder C800	09-13	SU-8009				KN-138*	*Chrome=KN-138C
805	VZ800 Marauder	09	SU-8009				KN-138*	*Chrome=KN-138C
850	GS850G	79-83	SU-1200		RC-0984*	RC-1820DK	KN-133	*Inc. 4 Filters
850	GS850G	84-85					KN-133	
850	GS850GL	79					KN-133	
850	GS850GL	80-83	SU-1200		RC-0984*	RC-1820DK	KN-133	*Inc. 4 Filters
850	GS850GL	84-85					KN-133	
900	RF900	00					KN-138*	*Chrome=KN-138C
938	RF900	98-99					KN-138*	*Chrome=KN-138C
938	RF900R	94-97	SU-9094				KN-138*	*Chrome=KN-138C
996	DL1000 V-Strom	02-10	SU-1002				KN-138*	*Chrome=KN-138C
996	DL1000 V-Strom	12-13	SU-1002				KN-138*	*Chrome=KN-138C
996	DL1000 V-Strom Adventure	12	SU-1002				KN-138*	*Chrome=KN-138C
996	DL1000 V-Strom GT	04	SU-1002				KN-138*	*Chrome=KN-138C
996	DL1000 V-Strom Touring	07	SU-1002				KN-138*	*Chrome=KN-138C
999	GSXR1000	01-04	SU-7500				KN-138*	*Chrome=KN-138C
999	GSXR1000	05-08	SU-1005				KN-138*	*Chrome=KN-138C
999	GSXR1000	05-08	SU-1005R*				KN-138**	*Race Specific/ **Chrome=KN-138C
999	GSXR1000	09-16	SU-1009				KN-138*	*Chrome=KN-138C
999	GSXR1000	09-16	SU-1009R*				KN-138**	*Race Specific/ **Chrome=KN-138C
999	GSXR1000	17	SU-1017					
999	GSXR1000 1 Million C.E.	13	SU-1009				KN-138*	*Chrome=KN-138C
999	GSXR1000 1 Million C.E.	13	SU-1009R*				KN-138**	*Race Specific/ **Chrome=KN-138C
999	GSXR1000 Commemorative Edition	16	SU-1009				KN-138*	*Chrome=KN-138C
999	GSXR1000 Commemorative Edition	16	SU-1009R*				KN-138**	*Race Specific/ **Chrome=KN-138C
999	GSXR1000 SE	14	SU-1009				KN-138*	*Chrome=KN-138C
999	GSXR1000 SE	14	SU-1009R*				KN-138**	*Race Specific/ **Chrome=KN-138C
999	GSXR1000R	17	SU-1017					
999	GSXS1000	16	SU-9915				KN-138*	*Chrome=KN-138C
999	GSXS1000 ABS	16	SU-9915				KN-138*	*Chrome=KN-138C
999	GSXS1000F ABS	16	SU-9915				KN-138*	*Chrome=KN-138C
1000	GS1000	78-79	SU-1250		RC-2454*	RC-1820DK	KN-133	*Inc. 4 Filters

2) Requires Two; 3) Requires Three; 4) Requires Four. The use of custom air filter requires removal of air box. Some custom filters and intakes are not legal for sale or use on any pollution controlled motor vehicle in California or states adopting California emission procedures. See knfilters.com for CARB status on each part for a specific vehicle.

Motorcycle - Application Listing



CC	Model	Year	Air Filter	Air Filter Precharger	Custom	Custom Precharger	Oil Filter	Comments
SUZUKI								
1000	GS1000	80-84					KN-133	
1000	GS1000E	78-80	SU-1250		RC-2454*	RC-1820DK	KN-133	*Inc. 4 Filters
1000	GS1000G	80-81	SU-1200		RC-0984*	RC-1820DK	KN-133	*Inc. 4 Filters
1000	GS1000G	82-83					KN-133	
1000	GS1000GL	80-81	SU-1200		RC-0984*	RC-1820DK	KN-133	*Inc. 4 Filters
1000	GS1000GL	82-83					KN-133	
1000	GS1000L	79	SU-1250		RC-2454*	RC-1820DK	KN-133	*Inc. 4 Filters
1000	GS1000S	79	SU-1250		RC-2454*	RC-1820DK	KN-133	*Inc. 4 Filters
1000	GS1000S	80	SU-1250		RC-0984*	RC-1820DK	KN-133	*Inc. 4 Filters
1000	GS1000S	81					KN-133	
1000	GS1000S	82	SU-1250		RC-0984*	RC-1820DK	KN-133	*Inc. 4 Filters
1000	GS1000S	83					KN-133	
1000	GSX1000 Katana	82-84					KN-138*	*Chrome=KN-138C
1000	SV1000	03-04	SU-6503				KN-138*	*Chrome=KN-138C
1000	SV1000	05-07					KN-138*	*Chrome=KN-138C
1000	SV1000S	03-07	SU-6503				KN-138*	*Chrome=KN-138C
1000	TL1000R	98-03	SU-0015				KN-138*	*Chrome=KN-138C
1000	TL1000S	97-01	SU-0007-A				KN-138*	*Chrome=KN-138C
1037	DL1000 V-Strom ABS	14-16	SU-1014				KN-138*	*Chrome=KN-138C
1037	DL1000 V-Strom ABS Adventure	14-16	SU-1014				KN-138*	*Chrome=KN-138C
1052	GSXR1100	86-88			RC-1824*	RC-1820DK	KN-138**	*Inc. 4 Filters/ **Chrome=KN-138C
1052	GSXR1100	89-92	SU-7588		RU-2922*		KN-138**	*Inc. 2 Filters/ **Chrome=KN-138C
1052	GSXR1100	94-98	SU-7593				KN-138*	*Chrome=KN-138C
1074	GSXR1100	93	SU-7593		RU-2922*		KN-138**	*Inc. 2 Filters/ **Chrome=KN-138C
1100	GS1100E	80-83	SU-1250		RC-0984*	RC-1820DK	KN-133	*Inc. 4 Filters
1100	GS1100G	82-83	SU-1200		RC-0984*	RC-1820DK	KN-133	*Inc. 4 Filters
1100	GS1100GK	82-84	SU-1200		RC-0984*	RC-1820DK	KN-133	*Inc. 4 Filters
1100	GS1100GK	85-86					KN-133	
1100	GS1100GL	81					KN-133	
1100	GS1100GL	82-83	SU-1200		RC-0984*	RC-1820DK	KN-133	*Inc. 4 Filters
1100	GS1100L	80	SU-1250		RC-0984*	RC-1820DK	KN-133	*Inc. 4 Filters
1100	GS1100L	81					KN-133	
1100	GS1100S	83	SU-1250		RC-0984*	RC-1820DK	KN-133	*Inc. 4 Filters
1100	GSX1100E	83	SU-1250				KN-133	
1100	GSX1100E	84-85	SU-1284				KN-133	
1100	GSX1100F Katana	87-94	SU-7592		RC-1824*	RC-1820DK	KN-138**	*Inc. 4 Filters/ **Chrome=KN-138C
1100	GSX1100F Katana	95-96					KN-138*	*Chrome=KN-138C
1100	GSX1100S Katana	81-84					KN-133	
1118	GSX1100G	91-96	SU-1191				KN-138*	*Chrome=KN-138C
1150	GS1150E	83-86	SU-1284		RC-0984*	RC-1820DK	KN-133	*Inc. 4 Filters
1150	GS1150ES	85	SU-1284		RC-0984*	RC-1820DK	KN-133	*Inc. 4 Filters
1200	GSF1200 Bandit	00					KN-138*	*Chrome=KN-138C
1200	GSF1200 Bandit	01-03	SU-6000				KN-138*	*Chrome=KN-138C
1200	GSF1200 Bandit	04-05					KN-138*	*Chrome=KN-138C
1200	GSF1200 Bandit	06	SU-6505				KN-138*	*Chrome=KN-138C
1200	GSF1200 Bandit S	96-00	SU-7593		RU-2922*		KN-138**	*Inc. 2 Filters/ **Chrome=KN-138C
1200	GSF1200 Bandit S	01-05	SU-6000				KN-138*	*Chrome=KN-138C
1200	GSF1200 Bandit S	06	SU-6505				KN-138*	*Chrome=KN-138C
1200	GSX1200 Inazuma	99-00					KN-138*	*Chrome=KN-138C
1200	GV1200 Madura	85-86	SU-5589				KN-134	
1250	GSF1250 Bandit	09-13	SU-6505				KN-138*	*Chrome=KN-138C
1250	GSF1250 Bandit	14	SU-6505					

2) Requires Two; 3) Requires Three; 4) Requires Four. The use of custom air filter requires removal of air box. Some custom filters and intakes are not legal for sale or use on any pollution controlled motor vehicle in California or states adopting California emission procedures. See knfilters.com for CARB status on each part for a specific vehicle.



Motorcycle - Application Listing

CC	Model	Year	Air Filter	Air Filter Precharger	Custom	Custom Precharger	Oil Filter	Comments
SUZUKI								
1250	GSF1250 Bandit	15	SU-6505				KN-138*	*Chrome=KN-138C
1250	GSF1250 Bandit S	07-12	SU-6505				KN-138*	*Chrome=KN-138C
1250	GSX1250FA	11	SU-6505				KN-138*	*Chrome=KN-138C
1250	GSX1250FA	12-14	SU-6505					
1250	GSX1250FA	15-16	SU-6505				KN-138*	*Chrome=KN-138C
1255	GSF1250 Bandit	16	SU-6505				KN-138*	*Chrome=KN-138C
1300	GSX1300R Hayabusa	99-07	SU-1399				KN-138*	*Chrome=KN-138C
1300	GSX1300R Hayabusa Limited Edition	06	SU-1399				KN-138*	*Chrome=KN-138C
1340	GSX1300BK B-King	07-12	SU-1348				KN-138*	*Chrome=KN-138C
1340	GSX1300R Hayabusa	08-16	SU-1308				KN-138*	*Chrome=KN-138C
1340	GSX1300R Hayabusa	08-16	SU-1308R*				KN-138**	*Race Specific/ **Chrome=KN-138C
1340	GSX1300R Hayabusa 50th Ann. Edition	14	SU-1308				KN-138*	*Chrome=KN-138C
1340	GSX1300R Hayabusa 50th Ann. Edition	14	SU-1308R*				KN-138**	*Race Specific/ **Chrome=KN-138C
1340	GSX1300R Hayabusa Limited Edition	13	SU-1308				KN-138*	*Chrome=KN-138C
1340	GSX1300R Hayabusa Limited Edition	13	SU-1308R*				KN-138**	*Race Specific/ **Chrome=KN-138C
1400	Boulevard S83	05-09	SU-1487				KN-138*	*Chrome=KN-138C
1400	GSX1400	01-07	SU-1402				KN-138*	*Chrome=KN-138C
1400	GV1400 Cavalcade	86					KN-134	
1400	GV1400 Cavalcade	87-89					KN-138*	*Chrome=KN-138C
1400	VS1400 Intruder	87-95	SU-1487				KN-138*	*Chrome=KN-138C
1400	VS1400GLP Intruder	96-04	SU-1487				KN-138*	*Chrome=KN-138C
1400	VS1400GLP Intruder	05-09					KN-138*	*Chrome=KN-138C
1462	Boulevard C90 BOSS	15					KN-138*	*Chrome=KN-138C
1462	Boulevard C90T	15					KN-138*	*Chrome=KN-138C
1462	Boulevard M90	15					KN-138*	*Chrome=KN-138C
1500	Boulevard C90	05-09	SU-1598				KN-138*	*Chrome=KN-138C
1500	Boulevard C90 Black	05-08	SU-1598				KN-138*	*Chrome=KN-138C
1500	Boulevard C90T	05-09	SU-1598				KN-138*	*Chrome=KN-138C
1500	Boulevard M90	09					KN-138*	*Chrome=KN-138C
1500	VL1500LC Intruder	98-05	SU-1598				KN-138*	*Chrome=KN-138C
1500	VL1500LC Intruder	06					KN-138*	*Chrome=KN-138C
1500	VL1500LC Intruder	07-08	SU-1598				KN-138*	*Chrome=KN-138C
1500	VL1500LC Intruder	09					KN-138*	*Chrome=KN-138C
1500	VZ1500 Boulevard	09					KN-138*	*Chrome=KN-138C
1500	VZ1500 Intruder M1500	09-10					KN-138*	*Chrome=KN-138C
1600	Boulevard M95	05	KA-1596				KN-204*	*Chrome=KN-204C
1600	VZ1600 Marauder	04-05	KA-1596				KN-204*	*Chrome=KN-204C
1773	Boulevard M109R	06-09	SU-1806				KN-138*	*Chrome=KN-138C
1773	Boulevard M109R	11	SU-1806				KN-138*	*Chrome=KN-138C
1773	Boulevard M109R Ltd. Ed.	07-09	SU-1806				KN-138*	*Chrome=KN-138C
1773	Boulevard M109R Ltd. Ed.	11	SU-1806				KN-138*	*Chrome=KN-138C
1773	Boulevard M109R Ltd. Ed.	13	SU-1806				KN-138*	*Chrome=KN-138C
1773	Boulevard M109R2	08-09	SU-1806				KN-138*	*Chrome=KN-138C
1783	Boulevard M109R	12-14	SU-1806				KN-138*	*Chrome=KN-138C
1783	Boulevard M109R BOSS	14-15	SU-1806				KN-138*	*Chrome=KN-138C
1783	Boulevard M109R BOSS	16	SU-1806					
1783	Boulevard M109R Ltd. Ed.	12	SU-1806				KN-138*	*Chrome=KN-138C
1783	Boulevard M109RZ Limited	11	SU-1806				KN-138*	*Chrome=KN-138C
1783	Boulevard M109RZ Limited	14	SU-1806				KN-138*	*Chrome=KN-138C
1800	Boulevard C109R	08-09					KN-138*	*Chrome=KN-138C
1800	Boulevard C109RT	08-09					KN-138*	*Chrome=KN-138C
1800	Boulevard C109T	08					KN-138*	*Chrome=KN-138C
1800	VLR1800 C109 Boulevard	08-10					KN-138*	*Chrome=KN-138C

2) Requires Two; 3) Requires Three; 4) Requires Four. The use of custom air filter requires removal of air box. Some custom filters and intakes are not legal for sale or use on any pollution controlled motor vehicle in California or states adopting California emission procedures. See knfilters.com for CARB status on each part for a specific vehicle.

Motorcycle - Application Listing



CC	Model	Year	Air Filter	Air Filter Precharger	Custom	Custom Precharger	Oil Filter	Comments
SUZUKI								
1800	VLR1800 C1800R Intruder	08-12	SU-1806*				KN-138**	*OEM 1378048G00/ **Chrome=KN-138C
1800	VLR1800 C1800RT Intruder	09	SU-1806*				KN-138**	*OEM 1378048G00/ **Chrome=KN-138C
1800	VLR1800 C1800RT Intruder	11	SU-1806*				KN-138**	*OEM 1378048G00/ **Chrome=KN-138C
1800	VZR1800 Intruder	06-10	SU-1806				KN-138*	*Chrome=KN-138C
TRIUMPH								
596	Speed Four	04	TB-6000				KN-191	
596	Speed Four	05-06	TB-6000				KN-204*	*Chrome=KN-204C
596	TT600	00-05	TB-6000				KN-191	
600	Daytona 600	03					KN-191	
600	Daytona 600	04	TB-6000				KN-204*	*Chrome=KN-204C
600	Speed Four	03	TB-6000				KN-191	
650	Daytona 650	05	TB-6000				KN-204*	*Chrome=KN-204C
671	Daytona 675	06-12	TB-6706				KN-204*	*Chrome=KN-204C
671	Daytona 675 SE	08-09	TB-6706				KN-204*	*Chrome=KN-204C
671	Daytona 675R	11-12	TB-6706				KN-204*	*Chrome=KN-204C
671	Street Triple	07	TB-6706					
671	Street Triple	08-10	TB-6706				KN-204*	*Chrome=KN-204C
671	Street Triple R	09-10	TB-6706				KN-204*	*Chrome=KN-204C
675	Daytona 675	13-14	TB-6713				KN-204*	*Chrome=KN-204C
675	Daytona 675	16	TB-6713				KN-204*	*Chrome=KN-204C
675	Daytona 675 ABS	15	TB-6713				KN-204*	*Chrome=KN-204C
675	Daytona 675R	13-14	TB-6713				KN-204*	*Chrome=KN-204C
675	Daytona 675R	16	TB-6713				KN-204*	*Chrome=KN-204C
675	Daytona 675R ABS	15	TB-6713				KN-204*	*Chrome=KN-204C
675	Street Triple	11-12	TB-6706				KN-204*	*Chrome=KN-204C
675	Street Triple	13	TB-6713				KN-204*	*Chrome=KN-204C
675	Street Triple ABS	14	TB-6713				KN-204*	*Chrome=KN-204C
675	Street Triple ABS	15	TB-6713					
675	Street Triple ABS	16	TB-6713				KN-204*	*Chrome=KN-204C
675	Street Triple R	11-12	TB-6706				KN-204*	*Chrome=KN-204C
675	Street Triple R	13	TB-6713				KN-204*	*Chrome=KN-204C
675	Street Triple R ABS	14	TB-6713				KN-204*	*Chrome=KN-204C
675	Street Triple R ABS	15	TB-6713					
675	Street Triple R ABS	16	TB-6713				KN-204*	*Chrome=KN-204C
675	Street Triple Rx	16					KN-204*	*Chrome=KN-204C
675	Street Triple Rx ABS	16	TB-6713				KN-204*	*Chrome=KN-204C
749	Trident 750	93-97	TB-9091				KN-192	
749	Trident 750	98					KN-192	
750	Daytona 750	91-95	TB-9091				KN-192	
750	Speed Triple 750	97					KN-192	
750	Thunderbird	95					KN-192	
750	Thunderbird	95					KN-401	
750	Trident 750	91					KN-192	
750	Trident 750	92	TB-9091				KN-192	
799	Tiger 800	11	TB-8011				KN-204*	*Chrome=KN-204C
799	Tiger 800 ABS	11-14	TB-8011				KN-204*	*Chrome=KN-204C
799	Tiger 800 XC	11	TB-8011				KN-204*	*Chrome=KN-204C
799	Tiger 800 XC	14-16	TB-8011				KN-204*	*Chrome=KN-204C
799	Tiger 800 XC ABS	11-13	TB-8011				KN-204*	*Chrome=KN-204C
799	Tiger 800 XC ABS	15-16	TB-8011				KN-204*	*Chrome=KN-204C
799	Tiger 800 XCca	16	TB-8011				KN-204*	*Chrome=KN-204C
799	Tiger 800 XCx	15-16	TB-8011				KN-204*	*Chrome=KN-204C
799	Tiger 800 XCx Low	16	TB-8011				KN-204*	*Chrome=KN-204C

2) Requires Two; 3) Requires Three; 4) Requires Four. The use of custom air filter requires removal of air box. Some custom filters and intakes are not legal for sale or use on any pollution controlled motor vehicle in California or states adopting California emission procedures. See knfilters.com for CARB status on each part for a specific vehicle.



Motorcycle - Application Listing

CC	Model	Year	Air Filter	Air Filter Precharger	Custom	Custom Precharger	Oil Filter	Comments
TRIUMPH								
799	Tiger 800 XR	15-16	TB-8011				KN-204*	*Chrome=KN-204C
799	Tiger 800 XRt	16	TB-8011				KN-204*	*Chrome=KN-204C
799	Tiger 800 XRx	15-16	TB-8011				KN-204*	*Chrome=KN-204C
799	Tiger 800 XRx Low	16	TB-8011				KN-204*	*Chrome=KN-204C
800	Bonneville	01-04	TB-9004				KN-191	
800	Bonneville	05	TB-9004				KN-204*	*Chrome=KN-204C
800	Bonneville T100	02-04	TB-9004				KN-191	
865	America	02					KN-191	
865	America	03	TB-8002				KN-191	
865	America	04-16	TB-8002				KN-204*	*Chrome=KN-204C
865	America Classic	11	TB-8002				KN-204*	*Chrome=KN-204C
865	America LT	14-16	TB-8002				KN-204*	*Chrome=KN-204C
865	Bonneville	06-15	TB-9004				KN-204*	*Chrome=KN-204C
865	Bonneville Newchurch SE	14	TB-9004				KN-204*	*Chrome=KN-204C
865	Bonneville SE	09-13	TB-9004				KN-204*	*Chrome=KN-204C
865	Bonneville Steve McQueen SE	12	TB-9004				KN-204*	*Chrome=KN-204C
865	Bonneville T100	05-15	TB-9004				KN-204*	*Chrome=KN-204C
865	Bonneville T100	16					KN-204*	*Chrome=KN-204C
865	Bonneville T100 110th Anniversary LE	12	TB-9004				KN-204*	*Chrome=KN-204C
865	Bonneville T100 Black	14-15	TB-9004				KN-204*	*Chrome=KN-204C
865	Bonneville T100 Black	16					KN-204*	*Chrome=KN-204C
865	Bonneville T100 Jet Black	11	TB-9004				KN-204*	*Chrome=KN-204C
865	Bonneville T214 SE	15					KN-204*	*Chrome=KN-204C
865	Scrambler	06-16	TB-9004				KN-204*	*Chrome=KN-204C
865	Speedmaster	03-16	TB-8002				KN-204*	*Chrome=KN-204C
865	Thruyton	04-15	TB-9004				KN-204*	*Chrome=KN-204C
865	Thruyton	16					KN-204*	*Chrome=KN-204C
865	Thruyton Ace SE	15	TB-9004				KN-204*	*Chrome=KN-204C
865	Thruyton SE	11	TB-9004				KN-204*	*Chrome=KN-204C
885	Adventurer 900	95					KN-192	
885	Adventurer 900	96-98	TB-9095				KN-192	
885	Adventurer 900	99-00	TB-9095				KN-204*	*Chrome=KN-204C
885	Adventurer 900	01	TB-9095				KN-192	
885	Daytona 900	94-96	TB-9091				KN-192	
885	Daytona 900	97					KN-192	
885	Legend TT	99-00	TB-9095				KN-204*	*Chrome=KN-204C
885	Legend TT	01	TB-9095				KN-192	
885	Speed Triple	94-96	TB-9091				KN-192	
885	Speed Triple	97	TB-9091				KN-192	
885	Speed Triple T509	97-98	TB-9097				KN-191	
885	Sprint	95-98	TB-9091				KN-192	
885	Thunderbird	95-98	TB-9095				KN-192	
885	Thunderbird	99-00	TB-9095				KN-204*	*Chrome=KN-204C
885	Thunderbird	01-03	TB-9095				KN-192	
885	Thunderbird Sport	98	TB-9095				KN-192	
885	Thunderbird Sport	99	TB-9095				KN-204*	*Chrome=KN-204C
885	Thunderbird Sport	00	TB-9095				KN-192	
885	Tiger	92-98	TB-9091				KN-192	
885	Tiger	99-00	TB-9097				KN-204*	*Chrome=KN-204C
885	Trident 900	91-98	TB-9091				KN-192	
885	Trophy 900	92-98	TB-9091				KN-192	
885	Trophy 900	99-00	TB-9091				KN-204*	*Chrome=KN-204C
885	Trophy 900	01	TB-9091				KN-192	
900	Daytona Super III	94-97	TB-9091				KN-192	
900	Sprint Sport	95-98					KN-401	

2) Requires Two; 3) Requires Three; 4) Requires Four. The use of custom air filter requires removal of air box. Some custom filters and intakes are not legal for sale or use on any pollution controlled motor vehicle in California or states adopting California emission procedures. See knfilters.com for CARB status on each part for a specific vehicle.

Motorcycle - Application Listing



CC	Model	Year	Air Filter	Air Filter Precharger	Custom	Custom Precharger	Oil Filter	Comments
TRIUMPH								
900	Thunderbird Sport	95-97	TB-9095				KN-192	
900	Thunderbird Sport	01-03	TB-9095				KN-192	
900	Thunderbolt	96					KN-192	
900	Tiger	91	TB-9091				KN-192	
900	Trophy 900	91	TB-9091				KN-192	
955	Daytona 955i	06	TB-9002				KN-204*	*Chrome=KN-204C
955	Daytona T595	97-98	TB-9097				KN-191	
955	Daytona T595	99-00	TB-9097					
955	Speed Triple 955i	05					KN-204*	*Chrome=KN-204C
955	Speed Triple T509	99-01	TB-9097					
955	Speed Triple T509	02	TB-9002					
955	Sprint ST	99-00	TB-9097					
955	Sprint ST	01	TB-9097				KN-204*	*Chrome=KN-204C
955	Sprint ST	02-04	TB-9002				KN-204*	*Chrome=KN-204C
956	Daytona 955i	99-00	TB-9097				KN-191	
956	Daytona 955i	01	TB-9097				KN-204*	*Chrome=KN-204C
956	Daytona 955i	02-05	TB-9002				KN-204*	*Chrome=KN-204C
956	Daytona 955i CE	02	TB-9002				KN-204*	*Chrome=KN-204C
956	Speed Triple	98	TB-9091					
956	Speed Triple	99-00	TB-9097				KN-191	
956	Speed Triple	01	TB-9097				KN-204*	*Chrome=KN-204C
956	Speed Triple	02-04	TB-9002				KN-204*	*Chrome=KN-204C
956	Sprint RS	99-00	TB-9097					
956	Sprint RS	01	TB-9097				KN-204*	*Chrome=KN-204C
956	Sprint RS	02-04	TB-9002				KN-204*	*Chrome=KN-204C
956	Tiger	01-06	TB-9097				KN-204*	*Chrome=KN-204C
1000	Daytona 1000	91-95	TB-9091				KN-192	
1050	Speed Triple	05-10	TB-1005				KN-204*	*Chrome=KN-204C
1050	Speed Triple	11-12	TB-1011				KN-204*	*Chrome=KN-204C
1050	Speed Triple ABS	11-15	TB-1011				KN-204*	*Chrome=KN-204C
1050	Speed Triple R	16	TB-1016				KN-204*	*Chrome=KN-204C
1050	Speed Triple R ABS	12-15	TB-1011				KN-204*	*Chrome=KN-204C
1050	Speed Triple S	16	TB-1016				KN-204*	*Chrome=KN-204C
1050	Speed Triple SE	13-14	TB-1011				KN-204*	*Chrome=KN-204C
1050	Sprint GT	11-12	TB-1005				KN-204*	*Chrome=KN-204C
1050	Sprint GT	13					KN-204*	*Chrome=KN-204C
1050	Sprint ST	05-11	TB-1005				KN-204*	*Chrome=KN-204C
1050	Tiger	07-11	TB-1005				KN-204*	*Chrome=KN-204C
1050	Tiger 1050	13	TB-1005				KN-204*	*Chrome=KN-204C
1050	Tiger 1050 ABS	10-11	TB-1005				KN-204*	*Chrome=KN-204C
1050	Tiger 1050 ABS SE	12	TB-1005				KN-204*	*Chrome=KN-204C
1050	Tiger 1050 SE	10-11	TB-1005				KN-204*	*Chrome=KN-204C
1050	Tiger 1050 SE	13	TB-1005				KN-204*	*Chrome=KN-204C
1050	Tiger Sport 1050	13	TB-1005				KN-204*	*Chrome=KN-204C
1179	Daytona 1200	93-97	TB-9091				KN-192	
1179	Trophy 1200	92-03	TB-9091				KN-192	
1200	Thruxton R	16					KN-204*	*Chrome=KN-204C
1200	Trophy 1200	91	TB-9091				KN-192	
1215	Tiger Explorer	12-14	TB-1212				KN-204*	*Chrome=KN-204C
1215	Tiger Explorer	16					KN-204*	*Chrome=KN-204C
1215	Tiger Explorer ABS	15	TB-1212				KN-204*	*Chrome=KN-204C
1215	Tiger Explorer XC	13-14	TB-1212				KN-204*	*Chrome=KN-204C
1215	Tiger Explorer XC	16					KN-204*	*Chrome=KN-204C
1215	Tiger Explorer XC ABS	15	TB-1212				KN-204*	*Chrome=KN-204C
1215	Tiger Explorer XCa	16	TB-1212				KN-204*	*Chrome=KN-204C

2) Requires Two; 3) Requires Three; 4) Requires Four. The use of custom air filter requires removal of air box. Some custom filters and intakes are not legal for sale or use on any pollution controlled motor vehicle in California or states adopting California emission procedures. See knfilters.com for CARB status on each part for a specific vehicle.



Motorcycle - Application Listing

CC	Model	Year	Air Filter	Air Filter Precharger	Custom	Custom Precharger	Oil Filter	Comments
TRIUMPH								
1215	Tiger Explorer XCx	16	TB-1212				KN-204*	*Chrome=KN-204C
1215	Tiger Explorer XR	16	TB-1212				KN-204*	*Chrome=KN-204C
1215	Tiger Explorer XRt	16	TB-1212				KN-204*	*Chrome=KN-204C
1215	Tiger Explorer XRx	16	TB-1212				KN-204*	*Chrome=KN-204C
1215	Trophy SE	13-16	TB-1213				KN-204*	*Chrome=KN-204C
1597	Thunderbird	10-14	TB-1610				KN-204*	*Chrome=KN-204C
1597	Thunderbird ABS	10-13	TB-1610				KN-204*	*Chrome=KN-204C
1597	Thunderbird SE	11	TB-1610				KN-204*	*Chrome=KN-204C
1597	Thunderbird Storm	11	TB-1610				KN-204*	*Chrome=KN-204C
1699	Thunderbird Comander	14					KN-204*	*Chrome=KN-204C
1699	Thunderbird Comander	16					KN-204*	*Chrome=KN-204C
1699	Thunderbird Comander ABS	15					KN-204*	*Chrome=KN-204C
1699	Thunderbird LT	14-16					KN-204*	*Chrome=KN-204C
1699	Thunderbird Storm	12-14	TB-1610				KN-204*	*Chrome=KN-204C
1699	Thunderbird Storm	16	TB-1610				KN-204*	*Chrome=KN-204C
1699	Thunderbird Storm ABS	12-13	TB-1610				KN-204*	*Chrome=KN-204C
1699	Thunderbird Storm ABS	15	TB-1610				KN-204*	*Chrome=KN-204C
1700	Thunderbird 1700	11	TB-1610				KN-204*	*Chrome=KN-204C
2294	Rocket III	04-10	TB-2204				KN-204*	*Chrome=KN-204C
2294	Rocket III Classic	06-10	TB-2204				KN-204*	*Chrome=KN-204C
2294	Rocket III Classic Tourer	07-11	TB-2204				KN-204*	*Chrome=KN-204C
2294	Rocket III Roadster	10-14	TB-2204				KN-204*	*Chrome=KN-204C
2294	Rocket III Roadster	16	TB-2204				KN-204*	*Chrome=KN-204C
2294	Rocket III Roadster ABS	15	TB-2204				KN-204*	*Chrome=KN-204C
2294	Rocket III Touring	12-14	TB-2204				KN-204*	*Chrome=KN-204C
2294	Rocket III Touring	16	TB-2204				KN-204*	*Chrome=KN-204C
2294	Rocket III Touring ABS	15	TB-2204				KN-204*	*Chrome=KN-204C
VICTORY								
1507	Kingpin	04-05	PL-1500				KN-198	
1507	Kingpin Ness Signature Series	05	PL-1500				KN-198	
1507	Standard Cruiser	02	PL-1500				KN-198	
1507	V92C Deluxe	01	PL-1500				KN-303*	*Chrome=KN-303C
1507	V92SC	00-01	PL-1500				KN-303*	*Chrome=KN-303C
1507	Vegas	03-05	PL-1500				KN-198	
1507	Vegas 8-Ball	05	PL-1500				KN-198	
1507	Vegas Ness Signature Series	05	PL-1500				KN-198	
1508	Classic Cruiser	03	PL-1500				KN-198	
1508	Deluxe Cruiser	02	PL-1500				KN-198	
1508	Deluxe Touring Cruiser	02	PL-1500				KN-198	
1508	Touring Cruiser	02-06	PL-1500				KN-198	
1508	V92C	98	PL-1598					
1508	V92C	99	PL-1598				KN-303*	*Chrome=KN-303C
1508	V92C	00-01	PL-1500				KN-303*	*Chrome=KN-303C
1508	V92C Special Edition	00	PL-1500				KN-303*	*Chrome=KN-303C
1634	Hammer	05-07	PL-1500				KN-198	
1634	Hammer	08	PL-1608				KN-198	
1634	Hammer S	07	PL-1500				KN-198	
1634	Hammer S	08	PL-1608				KN-198	
1634	Jackpot Arlen Ness	08	PL-1608				KN-198	
1634	Jackpot Cory Ness	08	PL-1608				KN-198	
1634	Jackpot Ness Signature Series	06-07	PL-1500				KN-198	
1634	Jackpot Ness Signature Series	08					KN-198	
1634	Kingpin	03					KN-198	
1634	Kingpin	06-07	PL-1500				KN-198	
1634	Kingpin	08-10	PL-1608				KN-198	

2) Requires Two; 3) Requires Three; 4) Requires Four. The use of custom air filter requires removal of air box. Some custom filters and intakes are not legal for sale or use on any pollution controlled motor vehicle in California or states adopting California emission procedures. See knfilters.com for CARB status on each part for a specific vehicle.

Motorcycle - Application Listing



CC	Model	Year	Air Filter	Air Filter Precharger	Custom	Custom Precharger	Oil Filter	Comments
VICTORY								
1634	Kingpin 8-Ball	08	PL-1608					
1634	Kingpin 8-Ball	09-10	PL-1608				KN-198	
1634	Kingpin Low	09	PL-1608				KN-198	
1634	Kingpin Low	10	PL-1608					
1634	Kingpin Tour	07	PL-1500					
1634	Kingpin Tour	08	PL-1608					
1634	Kingpin Tour	09	PL-1608				KN-198	
1634	Kingpin Tour	10	PL-1608					
1634	Vegas	06-07	PL-1500				KN-198	
1634	Vegas	08-10	PL-1608				KN-198	
1634	Vegas 8-Ball	06-07	PL-1500				KN-198	
1634	Vegas 8-Ball	08-10	PL-1608				KN-198	
1634	Vegas Jackpot	06-07	PL-1500				KN-198	
1634	Vegas Jackpot	08	PL-1608				KN-198	
1634	Vegas Low	08	PL-1608					
1634	Vegas Low	09	PL-1608				KN-198	
1634	Vegas Low	10	PL-1608					
1731	Arlen Ness Victory Vision	10					KN-198	
1731	Arlen Ness Vision	09					KN-198	
1731	Arlen Ness Vision	12-13					KN-198	
1731	Boardwalk	13-14	PL-1608				KN-198	
1731	Cross Country	10-16					KN-198	
1731	Cross Country 8-Ball	14-16					KN-198	
1731	Cross Country Cory Ness	11-13					KN-198	
1731	Cross Country Tour	12-16					KN-198	
1731	Cross Country Tour 15th Anniversary LE	14					KN-198	
1731	Cross Country Zach Ness	13					KN-198	
1731	Cross Roads	10-12					KN-198	
1731	Cross Roads 8-Ball	14					KN-198	
1731	Cross Roads Classic	13-14					KN-198	
1731	Gunner	15-16	PL-1608				KN-198	
1731	Hammer	09-11	PL-1608				KN-198	
1731	Hammer 8-Ball	10-15	PL-1608				KN-198	
1731	Hammer S	09-12	PL-1608				KN-198	
1731	Hammer S	16	PL-1608				KN-198	
1731	Hard-Ball	12-13					KN-198	
1731	High-Ball	11-16	PL-1608				KN-198	
1731	Jackpot	14	PL-1608				KN-198	
1731	Jackpot Cory Ness	09-10	PL-1608				KN-198	
1731	Judge	13-15	PL-1608				KN-198	
1731	Kingpin	11-12	PL-1608				KN-198	
1731	Kingpin 8-Ball	11	PL-1608				KN-198	
1731	Magnum	15-16					KN-198	
1731	Magnum X-1	15					KN-198	
1731	Magnum X-1 Stealth Edition	16					KN-198	
1731	Ness Cross Country	14					KN-198	
1731	Ness Magnum	15					KN-198	
1731	Vegas	11-12	PL-1608				KN-198	
1731	Vegas	16	PL-1608				KN-198	
1731	Vegas 8-Ball	11-16	PL-1608				KN-198	
1731	Vegas Jackpot	09-13	PL-1608				KN-198	
1731	Vegas Zach Ness	11-12	PL-1608				KN-198	
1731	Victory Vision Arlen Ness	09					KN-198	
1731	Victory Vision Arlen Ness	11					KN-198	
1731	Vision	16					KN-198	

2) Requires Two; 3) Requires Three; 4) Requires Four. The use of custom air filter requires removal of air box. Some custom filters and intakes are not legal for sale or use on any pollution controlled motor vehicle in California or states adopting California emission procedures. See knfilters.com for CARB status on each part for a specific vehicle.



Motorcycle - Application Listing

CC	Model	Year	Air Filter	Air Filter Precharger	Custom	Custom Precharger	Oil Filter	Comments
VICTORY								
1731	Vision 8-Ball	10-11					KN-198	
1731	Vision Street	08-09					KN-198	
1731	Vision Street Premium	09					KN-198	
1731	Vision Tour	08-15					KN-198	
1731	Vision Tour 10th Anniversary	09					KN-198	
YAMAHA								
49	YSR50	90			YA-0587			
50	YSR50	87-89			YA-0587			
50	YSR50	91-92			YA-0587			
80	PW80	83-08	YA-8083					
80	YZ80	81-82	R-1390					
80	YZ80	93-01	YA-8096	22-8088PK				
85	YZ85	03-17	YA-8502					
90	HT	70-73			RU-0310			
90	TTR90	00-04	YA-9001					
90	TTR90E	03-07	YA-9001					
100	RS100	02-03	YA-0102					
124	TTR125LE	11-17	YA-1201					
124	XT125	90-91					KN-143	
124	YBR125	05-15	YA-1213					
124	YBR125 Custom	08-15	YA-1213					
125	AT125	70-73			RU-0310			
125	DT125	78-79	YA-1078					
125	MT125	15	YA-1208				KN-140	
125	SR125	00-02					KN-143	
125	SR125SE	80-99					KN-143	
125	TTR125	00-04	YA-1201					
125	TTR125E	03-09	YA-1201					
125	TTR125L	00-09	YA-1201					
125	TTR125L	11	YA-1201					
125	TTR125LE	03-09	YA-1201					
125	TTR125LW	07	YA-1201					
125	TW125	99-04					KN-143	
125	WR125R	09-15	YA-1208				KN-141	
125	WR125X	09-15	YA-1208				KN-141	
125	XT125	82-89					KN-143	
125	XT125	92-96					KN-143	
125	XV125S Virago	97-01					KN-145	
125	XVS125 DragStar	00-04					KN-145	
125	YZ125	91-92	YA-2506XD	YA-4098-1DK				
125	YZ125	97-15	YA-2506XD	YA-4098-1DK				
125	YZ125	16	YA-2506XD	YA-4098-1DK			KN-140	
125	YZ125	17	YA-2506XD	YA-4098-1DK				
125	YZF R125	08-15	YA-1208				KN-141	
150	YZF R15	08-10	YA-1208					
150	YZF R15	11	YA-1208*					*to 9/11
153	FZ150 Fazer	09-11	YA-1611					
153	FZ16	08-11	YA-1611					
175	CT1	70-71			RU-0310			
175	CT2	72			RU-0310			
175	CT3	73			RU-0310			
175	DT175	78-79	YA-1078					
175	MX175	79-81	YA-1078					
185	SR185	81-82					KN-143	
194	AG200	90-92					KN-143	

2) Requires Two; 3) Requires Three; 4) Requires Four. The use of custom air filter requires removal of air box. Some custom filters and intakes are not legal for sale or use on any pollution controlled motor vehicle in California or states adopting California emission procedures. See knfilters.com for CARB status on each part for a specific vehicle.

Motorcycle - Application Listing



CC	Model	Year	Air Filter	Air Filter Precharger	Custom	Custom Precharger	Oil Filter	Comments
YAMAHA								
196	BW200	85-88					KN-143	
200	TW200	87-17	YA-2002				KN-143	
200	XT200	82-83					KN-143	
223	TTR230	05-16	YA-2305				KN-143	
223	TTR230	17	YA-2305					
225	TT225	86-87	YA-2292				KN-143	
225	TTR225	00-04	YA-2292				KN-143	
225	XT225	01-07	YA-2292				KN-143	
225	XT225 Serow	92-00	YA-2292				KN-143	
236	SR250	92-95					KN-145	
246	FZR250	93-94					KN-303*	*Chrome=KN-303C
247	XT250	90-92					KN-145	
250	DT250	74-77	YA-4074					
250	FZR250	89-90					KN-145*	*EXUP, MK1, MK2
250	FZR250	91-92					KN-303*	*Chrome=KN-303C
250	FZR250 Genesis	89					KN-145	
250	MX250	75			RU-1320			
250	RD250	73	YA-0700					
250	RD250	74-75	YA-0700		RC-1072*	22-8028PK		*Inc. 2 Filters
250	SR250	79-91					KN-145	
250	SR250	96					KN-145	
250	SR250T	81					KN-145	
250	SRX250	87					KN-143	
250	TT250	80-82					KN-145	
250	TTR250	00-06	YA-3586				KN-142	
250	WR250F	01-02	YA-2506XD	YA-4098-1DK			KN-142	
250	WR250F	03-08	YA-4503	YA-4503DK			KN-141	
250	WR250F	09	YA-4503	YA-4503DK			KN-140	
250	WR250F	11-13	YA-4503	YA-4503DK			KN-140	
250	WR250F	15-16	YA-4514XD	YA-4514DK			KN-140	
250	WR250F	17	YA-4514XD	YA-4514DK				
250	WR250R	07-08	YA-3586				KN-141	
250	WR250R	09-16	YA-3586				KN-140	
250	WR250R	17	YA-3586					
250	WR250X	07-08	YA-3586				KN-141	
250	WR250X	09-12	YA-3586				KN-140	
250	WR250X	13-14	YA-3586					
250	WR250X	15	YA-3586				KN-140	
250	XG250 Tricker	04-08					KN-141	
250	XS250	78-82					KN-144	
250	XT250	80-89					KN-145	
250	XT250	06					KN-141	
250	XT250	08	YA-2509				KN-141	
250	XT250	09-17	YA-2509				KN-140	
250	XT250L	84					KN-143	
250	XT250X	06					KN-141	
250	XT250X	08	YA-2509				KN-141	
250	XV250	88-95					KN-145	
250	XV250 Route 66	88-90	YA-2588				KN-145	
250	XV250 Route 66	95-97					KN-145	
250	XV250 Virago	91-94	YA-2588					
250	XV250 Virago	95-07	YA-2588				KN-145	
250	XV250 Virago	08-09					KN-145	
250	XV250 V-Star	08-16	YA-2588				KN-145	
250	XV250 V-Star	17	YA-2588					

2) Requires Two; 3) Requires Three; 4) Requires Four. The use of custom air filter requires removal of air box. Some custom filters and intakes are not legal for sale or use on any pollution controlled motor vehicle in California or states adopting California emission procedures. See knfilters.com for CARB status on each part for a specific vehicle.



Motorcycle - Application Listing

CC	Model	Year	Air Filter	Air Filter Precharger	Custom	Custom Precharger	Oil Filter	Comments
YAMAHA								
250	XV250S Virago	95-06					KN-145	
250	XVS250 DragStar	01-07					KN-145	
250	YBR250	08-12					KN-140	
250	YZ250	91-92	YA-2506XD	YA-4098-1DK				
250	YZ250	97-02	YA-2506XD	YA-4098-1DK				
250	YZ250	03-08	YA-2506XD	YA-4098-1DK			KN-141	
250	YZ250	09-14	YA-2506XD	YA-4098-1DK				
250	YZ250	15-17	YA-2506XD	YA-4098-1DK			KN-140	
250	YZ250F	01-02	YA-2506XD	YA-4098-1DK			KN-142	
250	YZ250F	03-08	YA-2506XD	YA-4098-1DK			KN-141	
250	YZ250F	09-13	YA-2506XD	YA-4098-1DK			KN-140	
250	YZ250F	14-16	YA-4514XD	YA-4514DK			KN-140	
250	YZ250F	17	YA-2506XD	YA-4098-1DK			KN-140	
250	YZ250FX	15-17	YA-4514XD	YA-4514DK			KN-140	
250	YZ250X	16-17	YA-2506XD	YA-4098-1DK			KN-140	
321	MT03	16	YA-3215				KN-204*	*Chrome=KN-204C
321	YZF R3	15	YA-3215				KN-204*	*Chrome=KN-204C
321	YZF R3	16	YA-3215					
343	TT350	90					KN-143	
348	BW350	87					KN-145	
348	BW350	88					KN-143	
350	R5	70-72	YA-0700					
350	RD350	73	YA-0700					
350	RD350	74-75	YA-0700		RC-1072*	22-8028PK		*Inc. 2 Filters
350	RZ350	84-85			RC-2452*	RC-1820DK		*Inc. 2 Filters
350	TT350	86-87	YA-3586				KN-143	
350	TT350	88-89					KN-143	
350	TT350	91-92					KN-143	
350	XT350	85-01					KN-143	
360	DT360	74	YA-4074					
394	FZ400	97-00					KN-144	
394	FZR400	90	YA-4085		RC-1824*	RC-1820DK	KN-144	*Inc. 4 Filters
394	XJR400	92-94					KN-303*	*Chrome=KN-303C
399	YZ400F	98	YA-2506XD	YA-4098-1DK			KN-142	
400	DT400	74-77	YA-4074					
400	FZR400	88-89	YA-4085		RC-1824*	RC-1820DK	KN-144	*Inc. 4 Filters
400	FZR400R	87					KN-144	
400	FZR400RR EXUP	90-94					KN-303*	*Chrome=KN-303C
400	RD400	76-79			RC-1082*	RC-1200PK		*Inc. 2 Filters
400	SR400	92-08	YA-4092				KN-145	
400	SR400	14	YA-5008					
400	SR400	15-16	YA-5008				KN-145	
400	SR400	17	YA-5008					
400	WR400F	98-02	YA-2506XD	YA-4098-1DK			KN-142	
400	XJ400	81	YA-1600		RC-2372*			*Inc. 2 Filters
400	XJ400	82	YA-1600		RC-2372*		KN-144	*Inc. 2 Filters
400	XJR400	95-97					KN-303*	*Chrome=KN-303C
400	XJR400R	98-07					KN-303*	*Chrome=KN-303C
400	XS400	77-83					KN-144	
400	XS400-2	78-79					KN-144	
400	XS400S	80-81					KN-144	
400	XT400	81-82					KN-145	
400	XT400	83-84					KN-145*	*4v
400	XVS400 DragStar	96-07	YA-6598				KN-145	
400	YZ400F	99	YA-2506XD	YA-4098-1DK			KN-142	

2) Requires Two; 3) Requires Three; 4) Requires Four. The use of custom air filter requires removal of air box. Some custom filters and intakes are not legal for sale or use on any pollution controlled motor vehicle in California or states adopting California emission procedures. See knfilters.com for CARB status on each part for a specific vehicle.

Motorcycle - Application Listing



CC	Model	Year	Air Filter	Air Filter Precharger	Custom	Custom Precharger	Oil Filter	Comments
YAMAHA								
426	WR426F	01-02	YA-2506XD	YA-4098-1DK			KN-142	
426	YZ426F	00-02	YA-2506XD	YA-4098-1DK			KN-142	
449	YFZ450R SE	08	YA-4504	YA-4504PK	YA-4504-T	YA-4504-TDK	KN-140	
449	YFZ450R SE	09-10	YA-4504	YA-4504PK			KN-140	
449	YFZ450X	10-11	YA-4504	YA-4504PK			KN-140	
449	YFZ450X Bill Ballance	10	YA-4504	YA-4504PK			KN-140	
450	WR450F	03-08	YA-4503	YA-4503DK			KN-141	
450	WR450F	09	YA-4503	YA-4503DK			KN-140	
450	WR450F	11-15	YA-4503	YA-4503DK			KN-140	
450	WR450F	16					KN-140	
450	YFZ450 Bill Ballance Edition	07					KN-140	
450	YZ450F	03-08	YA-2506XD	YA-4098-1DK			KN-141	
450	YZ450F	09	YA-2506XD	YA-4098-1DK			KN-140	
450	YZ450F	10-13	YA-4510	YA-4510DK			KN-140	
450	YZ450F	14-17	YA-4514XD	YA-4514DK			KN-140	
450	YZ450FX	16-17	YA-4514XD	YA-4514DK			KN-140	
500	SR500	78-81	YA-1050				KN-145	
500	SR500	82-00					KN-145	
500	TT500	76	YA-1100				KN-145	
500	TT500	77-81	YA-1100		RU-1060	25-1770	KN-145	
500	TT500	77-81	YA-1100		RU-1060	RU-0510PK	KN-145	
500	TT500	77-81	YA-1100		RU-1060	RU-0510PL	KN-145	
500	TT500	77-81	YA-1100		RU-1060	RU-0510PR	KN-145	
500	TT500	77-81	YA-1100		RU-1060	RU-0510PY	KN-145	
500	XS500	76-78			RC-1202*	22-8029PK		*Inc. 2 Filters
500	XS500	76-78			RC-1202*	RC-1200PK		*Inc. 2 Filters
500	XT500	76-81			RU-1060	25-1770	KN-145	
500	XT500	76-81			RU-1060	RU-0510PK	KN-145	
500	XT500	76-81			RU-1060	RU-0510PL	KN-145	
500	XT500	76-81			RU-1060	RU-0510PR	KN-145	
500	XT500	76-81			RU-1060	RU-0510PY	KN-145	
500	XT500	82-83					KN-145	
500	XT500	85					KN-145	
500	XV500 Virago	83-84					KN-145	
535	XV535	82					KN-145	
535	XV535 Virago	87-02					KN-145	
550	XJ550	84-85					KN-144	
550	XJ550 Maxim	81-83	YA-1600		RC-2372*		KN-144	*Inc. 2 Filters
550	XJ550 Seca	81-83	YA-1600		RC-2372*		KN-144	*Inc. 2 Filters
550	XT550	82-83	YA-1874				KN-145	
550	XZ550 Vision	82-83					KN-145	
581	XJ600 Seca II	95-99	YA-6092		RC-1824*	RC-1820DK	KN-303**	*Inc. 4 Filters/ **Chrome=KN-303C
592	YX600 Radian	90	YA-1600		RC-1824*	RC-1820DK	KN-144	*Inc. 4 Filters
595	TT600	90					KN-145	
599	YZF R6	99-05	YA-6001				KN-303*	*Chrome=KN-303C
599	YZF R6	06-07	YA-6006				KN-204*	*Chrome=KN-204C
599	YZF R6	08-16	YA-6008				KN-204*	*Chrome=KN-204C
599	YZF R6	08-16	YA-6008R*				KN-204**	*Race Specific/ **Chrome=KN-204C
599	YZF R6S	06-09	YA-6001				KN-303*	*Chrome=KN-303C
599	YZF R6S	10	YA-6008				KN-303*	*Chrome=KN-303C
599	YZF R6S	10	YA-6008R*				KN-303**	*Race Specific/ **Chrome=KN-303C
600	FJ600	84-86	YA-1684		RC-1824*	RC-1820DK	KN-144	*Inc. 4 Filters
600	FJ600	90-93	YA-1684		RC-1824*	RC-1820DK	KN-144	*Inc. 4 Filters

2) Requires Two; 3) Requires Three; 4) Requires Four. The use of custom air filter requires removal of air box. Some custom filters and intakes are not legal for sale or use on any pollution controlled motor vehicle in California or states adopting California emission procedures. See knfilters.com for CARB status on each part for a specific vehicle.



Motorcycle - Application Listing

CC	Model	Year	Air Filter	Air Filter Precharger	Custom	Custom Precharger	Oil Filter	Comments
YAMAHA								
600	FZ6	04-06	YA-6004				KN-303*	*Chrome=KN-303C
600	FZ6	07-09	YA-6004				KN-204*	*Chrome=KN-204C
600	FZ6 Fazer	04-06	YA-6004				KN-303*	*Chrome=KN-303C
600	FZ6 Fazer	07	YA-6004				KN-204*	*Chrome=KN-204C
600	FZ6 Fazer S2	07-09	YA-6004				KN-204*	*Chrome=KN-204C
600	FZ6 S2	07-09	YA-6004				KN-204*	*Chrome=KN-204C
600	FZ600	86-88	YA-1686		RC-1824*	RC-1820DK	KN-144	*Inc. 4 Filters
600	FZ600	89					KN-144	
600	FZ6N	08	YA-6004				KN-204*	*Chrome=KN-204C
600	FZ6R	09-16	YA-6009				KN-204*	*Chrome=KN-204C
600	FZ6R	17	YA-6009					
600	FZ6S	08	YA-6004				KN-204*	*Chrome=KN-204C
600	FZR600	89-90	YA-6089		RU-2852*		KN-144	*Inc. 2 Filters
600	FZR600	91-93	YA-6089		RU-2852*		KN-303**	*Inc. 2 Filters/ **Chrome=KN-303C
600	FZR600R	90	YA-6089		RU-2852*		KN-144	*Inc. 2 Filters
600	FZR600R	91-93	YA-6089		RU-2852*		KN-303**	*Inc. 2 Filters/ **Chrome=KN-303C
600	FZR600R	94-95	YA-6089*		RU-2852**		KN-303***	*US/ **US, Inc. 2 Filters/ ***Chrome=KN-303C
600	FZR600R	94-95	YA-6094*		RU-2852**		KN-303***	*Non-US/ **US, Inc. 2 Filters/ ***Chrome=KN-303C
600	FZR600R	96-99	YA-6089		RU-2852*		KN-303**	*Inc. 2 Filters/ **Chrome=KN-303C
600	FZS600 Fazer	98-03	YA-6098				KN-147	
600	SRX600	86	YA-6050		RC-1820*	RC-1820DK	KN-145	*Req Both Filters, 2 Inch. Flange
600	SRX600	86	YA-6050		RC-2450*	RC-1820DK	KN-145	*Req Both Filters, 1-3/4 Inch. Flange
600	SRX600	87-89					KN-145	
600	TT600	83-89	YA-6003				KN-145	
600	TT600	91-92					KN-145	
600	TT600	97					KN-143	
600	TT600E	99-00					KN-143	
600	TT600R	97-00					KN-143	
600	TT600R	01-03					KN-145	
600	TT600RE	04					KN-145	
600	XJ6	09-15	YA-6009				KN-204*	*Chrome=KN-204C
600	XJ6 Diversion	09-15	YA-6009				KN-204*	*Chrome=KN-204C
600	XJ600	84-86	YA-1684		RC-1824*	RC-1820DK	KN-144	*Inc. 4 Filters
600	XJ600	87-89					KN-144	
600	XJ600	90-93	YA-1684		RC-1824*	RC-1820DK	KN-144	*Inc. 4 Filters
600	XJ600	92	YA-1684		RC-1824*	RC-1820DK	KN-303**	*Inc. 4 Filters/ **Chrome=KN-303C
600	XJ600 Diversion	92-03	YA-6092		RC-1824*	RC-1820DK	KN-303**	*Inc. 4 Filters/ **Chrome=KN-303C
600	XJ600 Seca II	92-94	YA-6092		RC-1824*	RC-1820DK	KN-303**	*Inc. 4 Filters/ **Chrome=KN-303C
600	XJ600N Diversion	97-03					KN-303*	*Chrome=KN-303C
600	XS600	92					KN-303*	*Chrome=KN-303C
600	XS600	95					KN-303*	*Chrome=KN-303C
600	XT600	84-89	YA-6084				KN-145	
600	XT600	90	YA-6090				KN-145	
600	XT600	91-95					KN-145	
600	XT600 Tenere	83-87					KN-145	
600	XT600E	91-99	YA-6090				KN-145	
600	XT600E	00-03					KN-145	
600	XT600Z Tenere	88-89					KN-145	

2) Requires Two; 3) Requires Three; 4) Requires Four. The use of custom air filter requires removal of air box. Some custom filters and intakes are not legal for sale or use on any pollution controlled motor vehicle in California or states adopting California emission procedures. See knfilters.com for CARB status on each part for a specific vehicle.

Motorcycle - Application Listing



CC	Model	Year	Air Filter	Air Filter Precharger	Custom	Custom Precharger	Oil Filter	Comments
YAMAHA								
600	XT600Z Tenere	91					KN-145	
600	YX600 Radian	86-89	YA-1600		RC-1824*	RC-1820DK	KN-144	*Inc. 4 Filters
600	YX600 Radian	91	YA-1600				KN-144	
600	YZF R46	05					KN-303*	*Chrome=KN-303C
600	YZF600R	94-95	YA-6094				KN-303*	*Chrome=KN-303C
600	YZF600R	96-07	YA-6096				KN-303*	*Chrome=KN-303C
608	SRX600	90-94					KN-145	
650	XJ650 Maxim	80-83	YA-1650		RC-1824*	RC-1820DK	KN-144	*Inc. 4 Filters
650	XJ650 Maxim	84					KN-144	
650	XJ650 Midnight Special	81	YA-1650		RC-1824*	RC-1820DK	KN-144	*Inc. 4 Filters
650	XJ650 Seca	82	YA-1650				KN-144	
650	XJ650 Seca	83					KN-144	
650	XJ650 Seca Turbo	82	YA-1650				KN-144	
650	XJ650 Seca Turbo	83-85					KN-144	
650	XS650	70-75			RC-0982*	RC-1820DK		*Inc. 2 Filters
650	XS650	76-79	YA-1152		RC-0982*	RC-1820DK		*Inc. 2 Filters
650	XS650	80-83	YA-1892		RC-0982*	RC-1820DK		*Inc. 2 Filters
650	XS650-2	79	YA-1152		RC-0982*	RC-1820DK		*Inc. 2 Filters
650	XS650S	78-79	YA-1152		RC-0982*	RC-1820DK		*Inc. 2 Filters
650	XS650S	80-81	YA-1892		RC-0982*	RC-1820DK		*Inc. 2 Filters
650	XVS650 DragStar	96-02	YA-6598		RC-1090	22-8028PK	KN-145	
650	XVS650 DragStar	03-04	YA-6598				KN-145	
650	XVS650 V-Star	13-16	YA-6598				KN-145	
650	XVS650 V-Star Classic	98-10	YA-6598				KN-145	
650	XVS650 V-Star Custom	98-11	YA-6598				KN-145	
650	XVS650 V-Star Midnight Custom	06-10	YA-6598				KN-145	
650	XVS650 V-Star Silverado	02-11	YA-6598				KN-145	
650	XVS650A DragStar Classic	98-06	YA-6598				KN-145	
660	MT03	06-11	YA-6604				KN-145	
660	SZR660	96-97	YA-0086		RC-1820*	RC-1820DK	KN-145	*Req Both Filters
660	SZR660	96-97	YA-0086		RC-2450*	RC-1820DK	KN-145	*Req Both Filters
660	SZR660	98	YA-0086				KN-145	
660	XT660	08	YA-6604				KN-145	
660	XT660R	04-15	YA-6604				KN-145	
660	XT660X	10-11	YA-6604				KN-145	
660	XT660X	12-14	YA-6604				KN-145	
660	XT660X	15	YA-6604				KN-145	
660	XT660X Super Motard	04-10	YA-6604				KN-145	
660	XT660Z Tenere	08-13	YA-6608				KN-145	
660	XT660Z Tenere	14	YA-6608				KN-145	
660	XTZ660 Tenere	91-92					KN-145	
660	XTZ660 Tenere	93-98	YA-6090				KN-145	
660	XTZ660 Tenere	99					KN-145	
689	FZ-07	15-16	YA-6814				KN-204*	*Chrome=KN-204C
689	MT-07	14	YA-6814				KN-204*	*Chrome=KN-204C
689	MT-07	15	YA-6814				KN-204*	*Chrome=KN-204C
689	MT-07	16	YA-6814				KN-204*	*Chrome=KN-204C
689	XSR700	16	YA-6814				KN-204*	*Chrome=KN-204C
700	FZ700 Genesis	86-87	YA-7585		RU-2754*		KN-144	*Inc. 4 Filters
700	FZX700 Fazer	86-87	YA-7086		RC-1824*	RC-1820DK	KN-401	*Inc. 4 Filters
700	XJ700 Maxim	85-86	YA-7080		RC-1824*	RC-1820DK	KN-144	*Inc. 4 Filters
700	XJ700X Maxim X	85-86	YA-7080		RC-1824*	RC-1820DK	KN-144	*Inc. 4 Filters
700	XV700 Virago	84-87	YA-1186				KN-145	
741	FZ750 Genesis	90					KN-401	
741	YZF750 SP	93-98	YA-7593				KN-303*	*Chrome=KN-303C

2) Requires Two; 3) Requires Three; 4) Requires Four. The use of custom air filter requires removal of air box. Some custom filters and intakes are not legal for sale or use on any pollution controlled motor vehicle in California or states adopting California emission procedures. See knfilters.com for CARB status on each part for a specific vehicle.



Motorcycle - Application Listing

CC	Model	Year	Air Filter	Air Filter Precharger	Custom	Custom Precharger	Oil Filter	Comments
YAMAHA								
741	YZF750R	93					KN-303*	*Chrome=KN-303C
741	YZF750R	94-98	YA-7593		RU-3092*		KN-303**	*Inc. 2 Filters/ **Chrome=KN-303C
747	XV750 Virago	90-97	YA-1186				KN-145	
747	XV750 Virago	98-99					KN-145	
750	FZ750	85-86	YA-7585		RU-2754*		KN-401	*Inc. 4 Filters
750	FZ750	87					KN-401	
750	FZ750	88	YA-7585		RU-2754*		KN-401	*Inc. 4 Filters
750	FZ750 Genesis	87-89					KN-401	
750	FZ750 Genesis	91-94					KN-401	
750	FZR750	87-88	YA-7585		RU-2754*		KN-401	*Inc. 4 Filters
750	FZR750R	87-88	YA-7585		RU-2754*		KN-401	*Inc. 4 Filters
750	FZR750R	89-92					KN-401	
750	FZR750R - OWO1	87-88			RU-2922*		KN-401	*Inc. 2 Filters
750	FZR750R - OWO1	89					KN-401	
750	FZR750R - OWO1	90-92					KN-303*	*Chrome=KN-303C
750	FZX750	98					KN-401	
750	FZX750 Fazer	86-90					KN-401	
750	XJ750	81-84					KN-144	
750	XJ750 Maxim	82-83	YA-1650		RC-1824*	RC-1820DK	KN-144	*Inc. 4 Filters
750	XJ750M Midnight Maxim	83	YA-1650		RC-1824*	RC-1820DK	KN-144	*Inc. 4 Filters
750	XJ750R Seca	81-83	YA-1650		RC-1824*	RC-1820DK	KN-144	*Inc. 4 Filters
750	XJ750X Maxim X	85-86	YA-7080		RC-1824*	RC-1820DK	KN-144	*Inc. 4 Filters
750	XS750	76-77			RC-1203*	22-8029PK	KN-146	*Inc. 3 Filters
750	XS750	76-77			RC-1203*	RC-1200PK	KN-146	*Inc. 3 Filters
750	XS750	78-79	YA-1300		RC-1203*	22-8029PK	KN-146	*Inc. 3 Filters
750	XS750	78-79	YA-1300		RC-1203*	RC-1200PK	KN-146	*Inc. 3 Filters
750	XS750	80					KN-146	
750	XS750S	78-79	YA-1300		RC-1203*	22-8029PK	KN-146	*Inc. 3 Filters
750	XS750S	78-79	YA-1300		RC-1203*	RC-1200PK	KN-146	*Inc. 3 Filters
750	XV750 Virago	81-83	YA-1550				KN-145	
750	XV750 Virago	88-89	YA-1186				KN-145	
750	XV750M Midnight Virago	83	YA-1550				KN-145	
750	YZF R7	99-01					KN-303*	*Chrome=KN-303C
754	XTZ750 Super Tenere	89-97	YA-0075 ²				KN-145	
800	FZ8	10-15	YA-1006				KN-204*	*Chrome=KN-204C
847	FJ-09	15-16	YA-8514				KN-204*	*Chrome=KN-204C
847	FZ-09	14-16	YA-8514				KN-204*	*Chrome=KN-204C
847	MT09	14-15	YA-8514					
847	MT09	16	YA-8514				KN-204*	*Chrome=KN-204C
850	TDM850	91					KN-145	
850	TDM850	92-96	YA-7585		RU-2780	RU-2780DK	KN-145	
850	TDM850	97-98	YA-7585		RU-0810	25-1770	KN-145	
850	TDM850	97-98	YA-7585		RU-0810	RU-0510PK	KN-145	
850	TDM850	97-98	YA-7585		RU-0810	RU-0510PL	KN-145	
850	TDM850	97-98	YA-7585		RU-0810	RU-0510PR	KN-145	
850	TDM850	97-98	YA-7585		RU-0810	RU-0510PY	KN-145	
850	TDM850	99-02	YA-7585				KN-145	
850	TRX850	96-99	YA-8596				KN-145	
850	TRX850	00					KN-145	
850	XS850	80-81	YA-1300		RC-0983*	RC-1820DK	KN-146	*Inc. 3 Filters
850	XS850L	80-81	YA-1300		RC-0983*	RC-1820DK	KN-146	*Inc. 3 Filters
850	XS850S	80-81	YA-1300		RC-0983*	RC-1820DK	KN-146	*Inc. 3 Filters
850	XSR900	16-17	YA-8514					
897	TDM900	02-14	YA-9002				KN-145	
897	TDM900A	07-14	YA-9002				KN-145	

2) Requires Two; 3) Requires Three; 4) Requires Four. The use of custom air filter requires removal of air box. Some custom filters and intakes are not legal for sale or use on any pollution controlled motor vehicle in California or states adopting California emission procedures. See knfilters.com for CARB status on each part for a specific vehicle.

Motorcycle - Application Listing



CC	Model	Year	Air Filter	Air Filter Precharger	Custom	Custom Precharger	Oil Filter	Comments
YAMAHA								
900	XJ900F	84-90					KN-144	
900	XJ900R Seca	83	YA-9083		RC-1824*	RC-1820DK	KN-144	*Inc. 4 Filters
900	XJ900RK Seca	82					KN-144	
900	XJ900RK Seca	83	YA-9083		RC-1824*	RC-1820DK	KN-144	*Inc. 4 Filters
900	XJ900S Diversion	98-00					KN-303*	*Chrome=KN-303C
900	XJ900S Diversion	01	YA-7585				KN-303*	*Chrome=KN-303C
900	XJ900S Diversion	02-03					KN-303*	*Chrome=KN-303C
900	XJR900R Seca	84	YA-9083		RC-1824*	RC-1820DK	KN-144	*Inc. 4 Filters
903	XJ900F	91	YA-9083		RC-1824*	RC-1820DK	KN-144	*Inc. 4 Filters
903	XJ900F	92-93	YA-9083				KN-144	
903	XJ900S Diversion	94-97					KN-303*	*Chrome=KN-303C
920	XV920 Virago	81-86	YA-1550				KN-145	
920	XV920M Midnight Virago	83	YA-1550				KN-145	
942	SCR950	17	YA-9514					
942	XV950	14	YA-9514					
942	XV950	15	YA-9514				KN-204*	*Chrome=KN-204C
942	XV950	16	YA-9514					
942	XV950R	14	YA-9514					
942	XV950R	15	YA-9514				KN-204*	*Chrome=KN-204C
942	XV950R	16	YA-9514					
942	XVS950 Bolt	14-16	YA-9514		RK-3940		KN-204*	*Chrome=KN-204C
942	XVS950 Bolt	17	YA-9514					
942	XVS950 Bolt C-Spec	15	YA-9514				KN-204*	*Chrome=KN-204C
942	XVS950 Bolt C-Spec	16	YA-9514		RK-3940		KN-204*	*Chrome=KN-204C
942	XVS950 Bolt R-Spec	14-16	YA-9514		RK-3940		KN-204*	*Chrome=KN-204C
942	XVS950 Bolt R-Spec	17	YA-9514					
942	XVS950 Midnight Star	09-13	YA-1307				KN-204*	*Chrome=KN-204C
942	XVS950 V-Star	09-16	YA-1307				KN-204*	*Chrome=KN-204C
942	XVS950 V-Star	17	YA-1307					
942	XVS950 V-Star Tourer	09-15	YA-1307				KN-204*	*Chrome=KN-204C
990	FZR1000	90	YA-1089		RU-3092*		KN-401	*Inc. 2 Filters
990	FZR1000	91-95	YA-1089		RU-3092*		KN-303**	*Inc. 2 Filters/ **Chrome=KN-303C
990	GTS1000	93-97					KN-303*	*Chrome=KN-303C
998	FZ1 Fazer	06-13	YA-1006				KN-204*	*Chrome=KN-204C
998	FZ1 Fazer	14-15	YA-1006					
998	FZ-10	17					KN-204*	*Chrome=KN-204C
998	MT10	16	YA-1015					
998	MT10	16	YA-1015R*					*Race Specific
998	YZF R1	98-01	YA-1098				KN-303*	*Chrome=KN-303C
998	YZF R1	02-03	YA-1002				KN-303*	*Chrome=KN-303C
998	YZF R1	04-06	YA-1004				KN-303*	*Chrome=KN-303C
998	YZF R1	07-08	YA-1007				KN-204*	*Chrome=KN-204C
998	YZF R1	09-14	YA-1009				KN-204*	*Chrome=KN-204C
998	YZF R1	09-14	YA-1009R*				KN-204**	*Race Specific/ **Chrome=KN-204C
998	YZF R1	15-16	YA-1015				KN-204*	*Chrome=KN-204C
998	YZF R1	15-16	YA-1015R*				KN-204**	*Race Specific/ **Chrome=KN-204C
998	YZF R1 LE	06	YA-1004				KN-303*	*Chrome=KN-303C
998	YZF R1 LE	10	YA-1009				KN-204*	*Chrome=KN-204C
998	YZF R1 LE	10	YA-1009R*				KN-204**	*Race Specific/ **Chrome=KN-204C
998	YZF R1 SP	06	YA-1004				KN-303*	*Chrome=KN-303C
998	YZF R1M	15-16	YA-1015				KN-204*	*Chrome=KN-204C
998	YZF R1M	15-16	YA-1015R*				KN-204**	*Race Specific/ **Chrome=KN-204C

2) Requires Two; 3) Requires Three; 4) Requires Four. The use of custom air filter requires removal of air box. Some custom filters and intakes are not legal for sale or use on any pollution controlled motor vehicle in California or states adopting California emission procedures. See knfilters.com for CARB status on each part for a specific vehicle.



Motorcycle - Application Listing

CC	Model	Year	Air Filter	Air Filter Precharger	Custom	Custom Precharger	Oil Filter	Comments
YAMAHA								
998	YZF R1S	16	YA-1015				KN-204*	*Chrome=KN-204C
998	YZF R1S	16	YA-1015R*				KN-204**	*Race Specific/ **Chrome=KN-204C
1000	FZ1	01-05	YA-1001				KN-303*	*Chrome=KN-303C
1000	FZ1	06-15	YA-1006				KN-204*	*Chrome=KN-204C
1000	FZ1N	06	YA-1006				KN-204*	*Chrome=KN-204C
1000	FZ1N	08	YA-1006				KN-204*	*Chrome=KN-204C
1000	FZ1S	06	YA-1006				KN-204*	*Chrome=KN-204C
1000	FZ1S	08	YA-1006				KN-204*	*Chrome=KN-204C
1000	FZR1000	87-88	YA-7585		RC-2814*		KN-401	*Inc. 4 Filters
1000	FZR1000	89	YA-1089		RU-3092*		KN-401	*Inc. 2 Filters
1000	FZS1000 Fazer	01-05	YA-1001				KN-303*	*Chrome=KN-303C
1000	GTS1000	98-00					KN-303*	*Chrome=KN-303C
1000	MT01	10-11	YA-1605				KN-303*	*Chrome=KN-303C
1000	XV1000 SE	88-89					KN-145	
1000	XV1000 Virago	81-83					KN-145	
1000	XV1000 Virago	84-85	YA-1186				KN-145	
1000	YZF1000R	97	YA-1089		RU-3092*		KN-303**	*Inc. 2 Filters/ **Chrome=KN-303C
1000	YZF1000R Thunderace	96	YA-1089				KN-303*	*Chrome=KN-303C
1000	YZF1000R Thunderace	98-02	YA-1089				KN-303*	*Chrome=KN-303C
1063	BT1100 Bulldog	02-06	YA-7585				KN-145	
1100	FJ1100	84-85	YA-1184		RC-2814*		KN-401	*Inc. 4 Filters
1100	FJ1100	86					KN-401	
1100	XJ1100 Maxim	82					KN-146	
1100	XS1100	78-83	YA-1400		RC-0984*	RC-1820DK	KN-146	*Inc. 4 Filters
1100	XS1100	84					KN-146	
1100	XS1100L	80-81	YA-1400		RC-0984*	RC-1820DK	KN-146	*Inc. 4 Filters
1100	XS1100S	79-81	YA-1400		RC-0984*	RC-1820DK	KN-146	*Inc. 4 Filters
1100	XV1100 Virago	86-99	YA-1186				KN-145	
1100	XV1100 Virago	00					KN-145	
1100	XVS1100 DragStar	99-04	YA-1199				KN-145	
1100	XVS1100 DragStar	05					KN-145	
1100	XVS1100 V-Star	99	YA-1199				KN-145	
1100	XVS1100 V-Star Classic	99					KN-145	
1100	XVS1100 V-Star Classic	00-09	YA-1199				KN-145	
1100	XVS1100 V-Star Custom	00-09	YA-1199				KN-145	
1100	XVS1100 V-Star Midnight Custom	06-09	YA-1199				KN-145	
1100	XVS1100 V-Star Silverado	02-09	YA-1199				KN-145	
1100	XVS1100A DragStar Classic	99-07	YA-1199				KN-145	
1173	FJ1200	90-93	YA-1184		RC-2814*		KN-401	*Inc. 4 Filters
1173	FJ1200	94-95					KN-401	
1173	XJR1200	95	YA-1295		RC-0984*	RC-1820DK	KN-401	*Inc. 4 Filters
1173	XJR1200	96	YA-1295				KN-401	
1173	XJR1200	97-99	YA-1295		RC-0984*	RC-1820DK	KN-401	*Inc. 4 Filters
1173	XJR1200	00	YA-1295				KN-401	
1199	XTZ1200 Super Tenere	10-16	YA-1210				KN-204*	*Chrome=KN-204C
1199	XTZ1200 Super Tenere	17	YA-1210					
1199	XTZ1200 Super Tenere ES	14-16	YA-1210				KN-204*	*Chrome=KN-204C
1199	XTZ1200 Super Tenere ES	17	YA-1210					
1200	FJ1200	86-89	YA-1184		RC-2814*		KN-401	*Inc. 4 Filters
1200	FJ1200 - Legend Car	86-93			RC-2814*		KN-401	*Inc. 4 Filters
1200	FJ1200 - Legend Car	86-93			RC-3510 ²		KN-401	
1200	VMX1200 V-Max	85-95	YA-1285		RU-2989*		KN-146	*Jet kit required, purchase separately

2) Requires Two; 3) Requires Three; 4) Requires Four. The use of custom air filter requires removal of air box. Some custom filters and intakes are not legal for sale or use on any pollution controlled motor vehicle in California or states adopting California emission procedures. See knfilters.com for CARB status on each part for a specific vehicle.

Motorcycle - Application Listing



CC	Model	Year	Air Filter	Air Filter Precharger	Custom	Custom Precharger	Oil Filter	Comments
YAMAHA								
1200	VMX1200 V-Max	96-07	YA-1285		RU-2989*		KN-303**	*Jet kit required, purchase separately/ **Chrome=KN-303C
1200	XJR1200	01	YA-1295					
1200	XVZ1200 Venture Royale	83-85	YA-1283				KN-146	
1200	XVZ1200 Venture Royale	86					KN-146	
1235	XJR1300	00	YA-1295		RC-0984*	RC-1820DK	KN-401	*Inc. 4 Filters
1235	XJR1300	01-05	YA-1295				KN-401	
1251	XJR1300	07-15	YA-1308				KN-401	
1300	FJR1300	01-06	YA-1301				KN-148	
1300	FJR1300	13	YA-1301				KN-204*	*Chrome=KN-204C
1300	FJR1300A	03-09	YA-1301				KN-148	
1300	FJR1300A	10-16	YA-1301				KN-204*	*Chrome=KN-204C
1300	FJR1300AE	05-06	YA-1301				KN-148	
1300	FJR1300AE	07					KN-148	
1300	FJR1300AE	08-09	YA-1301				KN-148	
1300	FJR1300AE	14-16	YA-1301				KN-204*	*Chrome=KN-204C
1300	FJR1300AS	06-09	YA-1301				KN-148	
1300	FJR1300AS	10-11	YA-1301				KN-204*	*Chrome=KN-204C
1300	FJR1300AS	14-16	YA-1301				KN-204*	*Chrome=KN-204C
1300	FJR1300ES	14-16	YA-1301				KN-204*	*Chrome=KN-204C
1300	FJR1300ES	17	YA-1301					
1300	XJR1300	95-97	YA-1295					
1300	XJR1300	98-99	YA-1295				KN-401	
1300	XVS13 Stryker Bullet Cowl	15-16	YA-1307				KN-204*	*Chrome=KN-204C
1300	XVS1300 V-Star	07-09	YA-1307				KN-147	
1300	XVS1300 V-Star	11-17	YA-1307				KN-204*	*Chrome=KN-204C
1300	XVS1300 V-Star Deluxe	13-16	YA-1307				KN-204*	*Chrome=KN-204C
1300	XVS1300 V-Star Tourer	07-09	YA-1307				KN-147	
1300	XVS1300 V-Star Tourer	10-16	YA-1307				KN-204*	*Chrome=KN-204C
1300	XVS1300 V-Star Tourer	17	YA-1307					
1300	XVS13CA Stryker	11-16	YA-1307				KN-204*	*Chrome=KN-204C
1300	XVS13CA Stryker	17	YA-1307					
1300	XVZ13	85-88					KN-146	
1300	XVZ1300 Royal Star	96-98	YA-1595				KN-303*	*Chrome=KN-303C
1300	XVZ1300 Royal Star	99-02					KN-303*	*Chrome=KN-303C
1300	XVZ1300 Royal Star Boulevard	99-01	YA-1595				KN-303*	*Chrome=KN-303C
1300	XVZ1300 Royal Star Midnight Tour Deluxe	06-07	YA-1399				KN-303*	*Chrome=KN-303C
1300	XVZ1300 Royal Star Midnight Venture	02-07	YA-1399				KN-303*	*Chrome=KN-303C
1300	XVZ1300 Royal Star MM Ltd.	00	YA-1399				KN-303*	*Chrome=KN-303C
1300	XVZ1300 Royal Star Tour Classic	97					KN-303*	*Chrome=KN-303C
1300	XVZ1300 Royal Star Tour Classic	98-00	YA-1595				KN-303*	*Chrome=KN-303C
1300	XVZ1300 Royal Star Tour Deluxe	97-01	YA-1595				KN-303*	*Chrome=KN-303C
1300	XVZ1300 Royal Star Tour Deluxe	05-10	YA-1399				KN-303*	*Chrome=KN-303C
1300	XVZ1300 Royal Star Tour Deluxe S	08-09	YA-1399				KN-303*	*Chrome=KN-303C
1300	XVZ1300 Royal Star Venture	99-10	YA-1399				KN-303*	*Chrome=KN-303C
1300	XVZ1300 Royal Star Venture S	08-13	YA-1399				KN-303*	*Chrome=KN-303C
1300	XVZ1300 Venture Royale	86-93	YA-1283				KN-146	
1304	XVS1300A Midnight Star	07-12	YA-1307				KN-147	
1304	XVS1300A Midnight Star	13	YA-1307				KN-204*	*Chrome=KN-204C
1600	XV1600 Road Star	99-03	YA-1699		RK-3905-1*	E-3495PK	KN-303**	*Mirrored/ **Chrome=KN-303C
1600	XV1600 Road Star	99-03	YA-1699		RK-3915-1*	E-3495PK	KN-303**	*Grooved/ **Chrome=KN-303C
1600	XV1600 Road Star	99-03	YA-1699		RK-3925-1*	E-3495PK	KN-303**	*Flamed/ **Chrome=KN-303C
1600	XV1600 Road Star Ltd. Edition	03	YA-1699		RK-3905-1*	E-3495PK	KN-303**	*Mirrored/ **Chrome=KN-303C
1600	XV1600 Road Star Ltd. Edition	03	YA-1699		RK-3915-1*	E-3495PK	KN-303**	*Grooved/ **Chrome=KN-303C
1600	XV1600 Road Star Ltd. Edition	03	YA-1699		RK-3925-1*	E-3495PK	KN-303**	*Flamed/ **Chrome=KN-303C

2) Requires Two; 3) Requires Three; 4) Requires Four. The use of custom air filter requires removal of air box. Some custom filters and intakes are not legal for sale or use on any pollution controlled motor vehicle in California or states adopting California emission procedures. See knfilters.com for CARB status on each part for a specific vehicle.



Motorcycle - Application Listing

CC	Model	Year	Air Filter	Air Filter Precharger	Custom	Custom Precharger	Oil Filter	Comments
YAMAHA								
1600	XV1600 Road Star Midnight	00-03	YA-1699		RK-3905-1*	E-3495PK	KN-303**	*Mirrored/ **Chrome=KN-303C
1600	XV1600 Road Star Midnight	00-03	YA-1699		RK-3915-1*	E-3495PK	KN-303**	*Grooved/ **Chrome=KN-303C
1600	XV1600 Road Star Midnight	00-03	YA-1699		RK-3925-1*	E-3495PK	KN-303**	*Flamed/ **Chrome=KN-303C
1600	XV1600 Road Star Silverado	99-03	YA-1699		RK-3905-1*	E-3495PK	KN-303**	*Mirrored/ **Chrome=KN-303C
1600	XV1600 Road Star Silverado	99-03	YA-1699		RK-3915-1*	E-3495PK	KN-303**	*Grooved/ **Chrome=KN-303C
1600	XV1600 Road Star Silverado	99-03	YA-1699		RK-3925-1*	E-3495PK	KN-303**	*Flamed/ **Chrome=KN-303C
1600	XV1600 Road Star Silverado Ltd. Edition	03	YA-1699		RK-3905-1*	E-3495PK	KN-303**	*Mirrored/ **Chrome=KN-303C
1600	XV1600 Road Star Silverado Ltd. Edition	03	YA-1699		RK-3915-1*	E-3495PK	KN-303**	*Grooved/ **Chrome=KN-303C
1600	XV1600 Road Star Silverado Ltd. Edition	03	YA-1699		RK-3925-1*	E-3495PK	KN-303**	*Flamed/ **Chrome=KN-303C
1600	XV1600 Wild Star	99-04	YA-1699		RK-3905-1*	E-3495PK	KN-303**	*Mirrored/ **Chrome=KN-303C
1600	XV1600 Wild Star	99-04	YA-1699		RK-3915-1*	E-3495PK	KN-303**	*Grooved/ **Chrome=KN-303C
1600	XV1600 Wild Star	99-04	YA-1699		RK-3925-1*	E-3495PK	KN-303**	*Flamed/ **Chrome=KN-303C
1670	XV1700 Road Star Warrior	02-05	YA-1602		YA-1602-U*		KN-303**	*1 Filter for Speedstar Assy./ **Chrome=KN-303C
1670	XV1700 Road Star Warrior	06-09	YA-1602				KN-303*	*Chrome=KN-303C
1700	MT01	05-09	YA-1605				KN-303*	*Chrome=KN-303C
1700	VMX1700 V-Max	09-17	YA-1709				KN-303*	*Chrome=KN-303C
1700	XV1700 Road Star	04-09	YA-1704		RK-3905-1*	E-3495PK	KN-303**	*Mirrored/ **Chrome=KN-303C
1700	XV1700 Road Star	04-09	YA-1704		RK-3915-1*	E-3495PK	KN-303**	*Grooved/ **Chrome=KN-303C
1700	XV1700 Road Star	04-09	YA-1704		RK-3925-1*	E-3495PK	KN-303**	*Flamed/ **Chrome=KN-303C
1700	XV1700 Road Star Cast Wheels	05-06	YA-1704				KN-303*	*Chrome=KN-303C
1700	XV1700 Road Star Midnight	04-07	YA-1704		RK-3905-1*	E-3495PK	KN-303**	*Mirrored/ **Chrome=KN-303C
1700	XV1700 Road Star Midnight	04-07	YA-1704		RK-3915-1*	E-3495PK	KN-303**	*Grooved/ **Chrome=KN-303C
1700	XV1700 Road Star Midnight	04-07	YA-1704		RK-3925-1*	E-3495PK	KN-303**	*Flamed/ **Chrome=KN-303C
1700	XV1700 Road Star Midnight Silverado	04	YA-1704		RK-3905-1*	E-3495PK	KN-303**	*Mirrored/ **Chrome=KN-303C
1700	XV1700 Road Star Midnight Silverado	04	YA-1704		RK-3915-1*	E-3495PK	KN-303**	*Grooved/ **Chrome=KN-303C
1700	XV1700 Road Star Midnight Silverado	04	YA-1704		RK-3925-1*	E-3495PK	KN-303**	*Flamed/ **Chrome=KN-303C
1700	XV1700 Road Star Midnight Silverado	06-07	YA-1704		RK-3905-1*	E-3495PK	KN-303**	*Mirrored/ **Chrome=KN-303C
1700	XV1700 Road Star Midnight Silverado	06-07	YA-1704		RK-3915-1*	E-3495PK	KN-303**	*Grooved/ **Chrome=KN-303C
1700	XV1700 Road Star Midnight Silverado	06-07	YA-1704		RK-3925-1*	E-3495PK	KN-303**	*Flamed/ **Chrome=KN-303C
1700	XV1700 Road Star Midnight Warrior	07-09	YA-1602				KN-303*	*Chrome=KN-303C
1700	XV1700 Road Star S	08-12	YA-1704		RK-3905-1*	E-3495PK	KN-303**	*Mirrored/ **Chrome=KN-303C
1700	XV1700 Road Star S	08-12	YA-1704		RK-3915-1*	E-3495PK	KN-303**	*Grooved/ **Chrome=KN-303C
1700	XV1700 Road Star S	08-12	YA-1704		RK-3925-1*	E-3495PK	KN-303**	*Flamed/ **Chrome=KN-303C
1700	XV1700 Road Star S	13-14	YA-1704				KN-303*	*Chrome=KN-303C
1700	XV1700 Road Star Silverado	04-10	YA-1704		RK-3905-1*	E-3495PK	KN-303**	*Mirrored/ **Chrome=KN-303C
1700	XV1700 Road Star Silverado	04-10	YA-1704		RK-3915-1*	E-3495PK	KN-303**	*Grooved/ **Chrome=KN-303C
1700	XV1700 Road Star Silverado	04-10	YA-1704		RK-3925-1*	E-3495PK	KN-303**	*Flamed/ **Chrome=KN-303C
1700	XV1700 Road Star Silverado S	08-12	YA-1704		RK-3905-1*	E-3495PK	KN-303**	*Mirrored/ **Chrome=KN-303C
1700	XV1700 Road Star Silverado S	08-12	YA-1704		RK-3915-1*	E-3495PK	KN-303**	*Grooved/ **Chrome=KN-303C
1700	XV1700 Road Star Silverado S	08-12	YA-1704		RK-3925-1*	E-3495PK	KN-303**	*Flamed/ **Chrome=KN-303C
1700	XV1700 Road Star Silverado S	13-14	YA-1704				KN-303*	*Chrome=KN-303C
1700	XV1700PCM Road Star Midnight Warrior	05-06	YA-1704		RK-3905-1*	E-3495PK	KN-303**	*Mirrored/ **Chrome=KN-303C
1700	XV1700PCM Road Star Midnight Warrior	05-06	YA-1704		RK-3915-1*	E-3495PK	KN-303**	*Grooved/ **Chrome=KN-303C
1700	XV1700PCM Road Star Midnight Warrior	05-06	YA-1704		RK-3925-1*	E-3495PK	KN-303**	*Flamed/ **Chrome=KN-303C
1854	XV1900 Midnight Star	10-13	YA-1906				KN-303*	*Chrome=KN-303C
1854	XV1900 Raider	10	YA-1906				KN-303*	*Chrome=KN-303C
1854	XV1900 Raider	11-15	YA-1906				KN-204*	*Chrome=KN-204C
1854	XV1900 Raider S	10	YA-1906				KN-303*	*Chrome=KN-303C
1854	XV1900 Raider S	11-15	YA-1906				KN-204*	*Chrome=KN-204C
1854	XV1900 Roadliner	12-13	YA-1906				KN-204*	*Chrome=KN-204C
1854	XV1900 Roadliner S	14	YA-1906				KN-204*	*Chrome=KN-204C
1854	XV1900 Stratoliner	13	YA-1906				KN-204*	*Chrome=KN-204C
1854	XV1900 Stratoliner Deluxe	12	YA-1906				KN-204*	*Chrome=KN-204C
1854	XV1900 Stratoliner Deluxe	14	YA-1906				KN-204*	*Chrome=KN-204C
1854	XV1900 Stratoliner S	12	YA-1906				KN-204*	*Chrome=KN-204C

2) Requires Two; 3) Requires Three; 4) Requires Four. The use of custom air filter requires removal of air box. Some custom filters and intakes are not legal for sale or use on any pollution controlled motor vehicle in California or states adopting California emission procedures. See knfilters.com for CARB status on each part for a specific vehicle.

Motorcycle - Application Listing



CC	Model	Year	Air Filter	Air Filter Precharger	Custom	Custom Precharger	Oil Filter	Comments
YAMAHA								
1854	XV1900 Stratoliner S	14	YA-1906				KN-204*	*Chrome=KN-204C
1854	XV19C Raider	15-16	YA-1906				KN-204*	*Chrome=KN-204C
1854	XV19C Raider	17	YA-1906					
1854	XV19C Raider Bullet Cowl	15	YA-1906				KN-204*	*Chrome=KN-204C
1854	XV19C Raider SCL	12-13					KN-204*	*Chrome=KN-204C
1854	XV19C Raider SCL	14	YA-1906				KN-204*	*Chrome=KN-204C
1854	XV19CS Raider S	15	YA-1906				KN-204*	*Chrome=KN-204C
1900	XV1900 Midnight Star	06-09	YA-1906				KN-303*	*Chrome=KN-303C
1900	XV1900 Raider	08-09	YA-1906				KN-303*	*Chrome=KN-303C
1900	XV1900 Raider S	08-09	YA-1906				KN-303*	*Chrome=KN-303C
1900	XV1900 Roadliner	06-07	YA-1906				KN-303*	*Chrome=KN-303C
1900	XV1900 Roadliner	10	YA-1906				KN-303*	*Chrome=KN-303C
1900	XV1900 Roadliner Midnight	06-09	YA-1906				KN-303*	*Chrome=KN-303C
1900	XV1900 Roadliner S	06-11	YA-1906				KN-303*	*Chrome=KN-303C
1900	XV1900 Stratoliner	06-07	YA-1906				KN-303*	*Chrome=KN-303C
1900	XV1900 Stratoliner	09-10	YA-1906				KN-303*	*Chrome=KN-303C
1900	XV1900 Stratoliner Deluxe	10-11	YA-1906				KN-303*	*Chrome=KN-303C
1900	XV1900 Stratoliner Midnight	06-08	YA-1906				KN-303*	*Chrome=KN-303C
1900	XV1900 Stratoliner S	06-11	YA-1906				KN-303*	*Chrome=KN-303C

2) Requires Two; 3) Requires Three; 4) Requires Four. The use of custom air filter requires removal of air box. Some custom filters and intakes are not legal for sale or use on any pollution controlled motor vehicle in California or states adopting California emission procedures. See knfilters.com for CARB status on each part for a specific vehicle.



ATV - Application Listing

CC	Model	Year	Air Filter	Air Filter Precharger	Custom	Custom Precharger	Oil Filter	Comments
ARCTIC CAT								
249	250 2x4	99-05	AC-3098	AC-3098PK			KN-132	
249	250 2x4	06-09	KY-2504	SU-2504PK				
250	DVX250	06-08	KY-2504	SU-2504PK				
280	300	10	KY-2504	SU-2504PK				
280	300 2x4	98-03	AC-3098	AC-3098PK			KN-132	
280	300 4x4	98-05	AC-3098	AC-3098PK			KN-132	
280	300 4x4 MRP	04	AC-3098	AC-3098PK			KN-132	
280	300 DVX	10	KY-2504	SU-2504PK				
300	DVX300	09	KY-2504	SU-2504PK				
366	366 4x4 Auto	08-09					KN-621	
366	400	15					KN-621	
371	400	98-02	AC-4096-1	AC-4096PK			KN-138*	*Chrome=KN-138C
376	375 2x4	02	AC-4096-1	AC-4096PK			KN-138*	*Chrome=KN-138C
376	400	03-04	AC-4096-1	AC-4096PK			KN-138*	*Chrome=KN-138C
400	400 4x4	01-05	AC-4096-1	AC-4096PK			KN-138*	*Chrome=KN-138C
400	400 4x4	06-07	AC-4004				KN-138*	*Chrome=KN-138C
400	400 4x4 ACT	03-04	AC-4096-1	AC-4096PK			KN-138*	*Chrome=KN-138C
400	400 4x4 Auto	03-05	AC-4096-1	AC-4096PK			KN-138*	*Chrome=KN-138C
400	400 4x4 Auto	06-08	AC-4004				KN-138*	*Chrome=KN-138C
400	400 4x4 Auto ACT	03-04	AC-4096-1	AC-4096PK			KN-138*	*Chrome=KN-138C
400	400 4x4 Auto LE	05	AC-4096-1	AC-4096PK			KN-138*	*Chrome=KN-138C
400	400 4x4 Auto LE	06-07	AC-4004				KN-138*	*Chrome=KN-138C
400	400 4x4 Auto MRP	03	AC-4096-1	AC-4096PK			KN-138*	*Chrome=KN-138C
400	400 4x4 Auto TBX	04-05	AC-4096-1	AC-4096PK			KN-138*	*Chrome=KN-138C
400	400 4x4 Auto TBX	06	AC-4004				KN-138*	*Chrome=KN-138C
400	400 4x4 Auto TRV	06	AC-4004				KN-138*	*Chrome=KN-138C
400	400 4x4 Auto TRV	09	AC-4004				KN-138*	*Chrome=KN-138C
400	400 4x4 Auto TRV Plus	07	AC-4004				KN-138*	*Chrome=KN-138C
400	400 4x4 Auto VP	05-06	AC-4096-1	AC-4096PK			KN-138*	*Chrome=KN-138C
400	400 4x4 VP	05-06	AC-4096-1	AC-4096PK			KN-138*	*Chrome=KN-138C
400	DVX400	04-08	SU-4002	SU-4002PK	SU-4002-T	SU-4002-TDK	KN-139	
400	DVX400 TS	06-07	SU-4002	SU-4002PK	SU-4002-T	SU-4002-TDK	KN-139	
400	TRV400	09-10					KN-621	
443	450	15					KN-621	
443	500	15-16					KN-621	
443	Prowler HDX 500	14					KN-621	
443	Prowler HDX 500	15	AC-7009				KN-621	
443	Prowler HDX 500 Limited	14					KN-621	
443	Prowler HDX 500 XT	14					KN-621	
443	TRV500	15					KN-621	
443	XC450	16					KN-621	
443	XR500	15					KN-621	
454	454 2x4	96-98	AC-4096-1	AC-4096PK			KN-138*	*Chrome=KN-138C
454	454 4x4	96-98	AC-4096-1	AC-4096PK			KN-138*	*Chrome=KN-138C
487	500 4x4	98-02	AC-4096-1	AC-4096PK			KN-138*	*Chrome=KN-138C
500	500 4x4	03-04					KN-138*	*Chrome=KN-138C
500	500 4x4	05-08	AC-4004				KN-138*	*Chrome=KN-138C
500	500 4x4	09	AC-4004				KN-621	
500	500 4x4 Auto	00-02	AC-4096-1	AC-4096PK			KN-138*	*Chrome=KN-138C
500	500 4x4 Auto	03-04					KN-138*	*Chrome=KN-138C
500	500 4x4 Auto	05-07	AC-4004				KN-138*	*Chrome=KN-138C
500	500 4x4 Auto	08-09	AC-4004				KN-621	
500	500 4x4 Auto LE	05-06	AC-4004				KN-138*	*Chrome=KN-138C
500	500 4x4 Auto M4	08	AC-4004				KN-621	
500	500 4x4 Auto MRP	03-04					KN-138*	*Chrome=KN-138C

2) Requires Two; 3) Requires Three; 4) Requires Four. The use of custom air filter requires removal of air box. Some custom filters and intakes are not legal for sale or use on any pollution controlled motor vehicle in California or states adopting California emission procedures. See knfilters.com for CARB status on each part for a specific vehicle.

ATV - Application Listing



CC	Model	Year	Air Filter	Air Filter Precharger	Custom	Custom Precharger	Oil Filter	Comments
ARCTIC CAT								
500	500 4x4 Auto TBX	02	AC-4096-1	AC-4096PK			KN-138*	*Chrome=KN-138C
500	500 4x4 Auto TBX	03-04					KN-138*	*Chrome=KN-138C
500	500 4x4 Auto TBX	05-06	AC-4004				KN-138*	*Chrome=KN-138C
500	500 4x4 Auto TRV	04-05					KN-138*	*Chrome=KN-138C
500	500 4x4 Auto TRV	06	AC-4004				KN-138*	*Chrome=KN-138C
500	500 4x4 Auto TRV	08	AC-4004				KN-621	
500	500 4x4 MRP	03-04					KN-138*	*Chrome=KN-138C
545	550	14	AC-7009				KN-621	
545	550 4x4 Auto	10-11	AC-7009				KN-621	
545	550 4x4 Auto	12-13					KN-621	
545	550 4x4 Auto LE	10	AC-7009				KN-621	
545	550 Core	13	AC-7009				KN-621	
545	550 H1 EFI	09-11	AC-7009				KN-621	
545	550 LTD	11	AC-7009					
545	550 LTD	14	AC-7009				KN-621	
545	550 XT	13-14	AC-7009				KN-621	
545	550i LTD	12-13	AC-7009				KN-621	
545	Alterra 550	16					KN-621	
545	Alterra 550XT	16					KN-621	
545	Prowler 550 H1 EFI	09	AC-7009				KN-621	
545	Prowler XT 550	10-11	AC-7009				KN-621	
545	Prowler XT 550	14	AC-7009				KN-621	
545	Prowler XT 550i	12-13	AC-7009				KN-621	
545	TRV550 H1 EFI	09-11	AC-7009				KN-621	
545	TRV550 LTD	13-15	AC-7009				KN-621	
545	TRV550 XT	13-15	AC-7009				KN-621	
545	TRV550 XT	16					KN-621	
545	TRV550i GT EFI	12	AC-7009				KN-621	
545	XR550	15					KN-621	
545	XR550 LTD	15					KN-621	
545	XR550 XT	15					KN-621	
550	550i	12	AC-7009				KN-621	
550	550i GT	12	AC-7009				KN-621	
550	TRV550i Cruiser EFI	12	AC-7009				KN-621	
641	650 H1 4x4 Auto	05	AC-4004				KN-138*	*Chrome=KN-138C
641	650 H1 4x4 Auto	07	AC-4004				KN-621	
641	650 H1 4x4 Auto	08-09	AC-7009				KN-621	
641	650 H1 4x4 Auto	10	AC-4004				KN-621	
641	650 H1 4x4 Auto	11	AC-4004					
641	650 H1 4x4 Auto LE	07	AC-4004				KN-621	
641	650 H1 4x4 Auto TBX	07	AC-4004				KN-621	
641	650 H1 4x4 Auto TBX	09	AC-7009					
641	650 H1 4x4 Auto TRV	08	AC-7009				KN-621	
641	650 H1 4x4 Auto TRV Plus	07	AC-4004				KN-621	
641	650 Mudpro 4x4	10-11	AC-7009					
641	MudPro 650	11	AC-7009					
641	Prowler 650 H1	07	AC-4004				KN-621	
641	Prowler 650 H1	08-09	AC-7009					
641	TRV650 H1	08	AC-7009					
641	TRV650 H1	09	AC-7009				KN-621	
650	650 4x4 Auto	04	AC-6504				KN-204*	*Chrome=KN-204C
650	650 4x4 Auto LE	04	AC-6504				KN-204*	*Chrome=KN-204C
650	650 H1 4x4 SE	06	AC-6504				KN-621	
650	650 H1 4x4 TRV Plus LE	07	AC-4004				KN-621	
650	650 V2 4x4	06	AC-6504				KN-204*	*Chrome=KN-204C

2) Requires Two; 3) Requires Three; 4) Requires Four. The use of custom air filter requires removal of air box. Some custom filters and intakes are not legal for sale or use on any pollution controlled motor vehicle in California or states adopting California emission procedures. See knfilters.com for CARB status on each part for a specific vehicle.



ATV - Application Listing

CC	Model	Year	Air Filter	Air Filter Precharger	Custom	Custom Precharger	Oil Filter	Comments
ARCTIC CAT								
650	650 V2 4x4 Auto	04					KN-204*	*Chrome=KN-204C
650	650 V2 4x4 Auto	05	AC-6504				KN-204*	*Chrome=KN-204C
650	650 V2 4x4 Auto LE	04					KN-204*	*Chrome=KN-204C
650	650 V2 4x4 Auto LE	05	AC-6504				KN-204*	*Chrome=KN-204C
650	650 V2 4x4 LE TS	06	AC-6504				KN-204*	*Chrome=KN-204C
650	Prowler 650 4x4 Auto	08	AC-7009				KN-621	
650	Prowler XT 650 4x4 Auto	08					KN-621	
650	Prowler XT 650 4x4 Auto M4	08-09	AC-7009				KN-621	
650	Prowler XT 650 H1	06-07	AC-4004				KN-621	
650	Prowler XT 650 H1	08					KN-621	
650	Prowler XT 650 H1	09	AC-7009				KN-621	
650	TBX650	09	AC-7009				KN-621	
695	700	14	AC-7009				KN-621	
695	700 Core	13	AC-7009				KN-621	
695	700 H1 EFI	08-12	AC-7009				KN-621	
695	700 H1 EFI 4x4 Auto SE	08					KN-621	
695	700 H1 EFI LE	09	AC-7009				KN-621	
695	700 H1 EFI Mudpro	09-11	AC-7009				KN-621	
695	700 H1 EFI SE	09	AC-7009				KN-621	
695	700 XT	13-14	AC-7009				KN-621	
695	700 XT	15	AC-7009					
695	700i LTD	13-14	AC-7009				KN-621	
695	700i LTD	15	AC-7009					
695	700S	10-11	AC-7009				KN-621	
695	Alterra 700	16					KN-621	
695	Alterra 700XT	16					KN-621	
695	HDX 700 SE Hunter Edition	16					KN-621	
695	HDX 700XT	16					KN-621	
695	MudPro 700	11	AC-7009				KN-621	
695	MudPro 700 LTD	12-14	AC-7009				KN-621	
695	MudPro 700 LTD	15-16					KN-621	
695	MudPro 700i	12	AC-7009				KN-621	
695	Prowler 700	08	AC-7009					
695	Prowler 700	10	AC-7009				KN-621	
695	Prowler HDX 700	11	AC-7009				KN-621	
695	Prowler HDX 700 Limited	14					KN-621	
695	Prowler HDX 700 XT	15	AC-7009				KN-621	
695	Prowler HDX 700i	13	AC-7009				KN-621	
695	Prowler XT 700	15-16					KN-621	
695	Prowler XT 700 H1 EFI	09	AC-7009				KN-621	
695	Prowler XTX 700	10-11	AC-7009				KN-621	
695	Prowler XTX 700	14					KN-621	
695	Prowler XTX 700 H1 EFI	10-11	AC-7009				KN-621	
695	Prowler XTX 700i	13	AC-7009				KN-621	
695	TBX700	14-15	AC-7009				KN-621	
695	TBX700	16					KN-621	
695	TBX700 LTD	11	AC-7009					
695	TBX700 SE	16					KN-621	
695	TBX700 XT	13	AC-7009				KN-621	
695	TRV700 H1 EFI	09-12	AC-7009				KN-621	
695	TRV700 LTD	13-15	AC-7009				KN-621	
695	TRV700 S	10-11	AC-7009				KN-621	
695	TRV700 SE	16					KN-621	
695	TRV700 T3S	16					KN-621	
695	TRV700 XT	13-15	AC-7009				KN-621	

2) Requires Two; 3) Requires Three; 4) Requires Four. The use of custom air filter requires removal of air box. Some custom filters and intakes are not legal for sale or use on any pollution controlled motor vehicle in California or states adopting California emission procedures. See knfilters.com for CARB status on each part for a specific vehicle.

ATV - Application Listing



CC	Model	Year	Air Filter	Air Filter Precharger	Custom	Custom Precharger	Oil Filter	Comments
ARCTIC CAT								
695	TRV700i GT	12	AC-7009				KN-621	
695	XR700	15					KN-621	
695	XR700 LTD	15					KN-621	
695	XR700 XT	15					KN-621	
700	700 EFI 4x4 Auto	07-08					KN-621	
700	700 EFI 4x4 Auto LE	07					KN-621	
700	700 EFI 4x4 Auto M4	08					KN-621	
700	700 EFI 4x4 Auto TRV LE	08					KN-621	
700	700i	12	AC-7009				KN-621	
700	700i GT	12	AC-7009				KN-621	
700	700i LTD	12	AC-7009				KN-621	
700	Prowler XTX 700 H1 EFI	09					KN-621	
700	Prowler XTX 700 H1 EFI LE	09					KN-621	
700	TBX700i GT	12	AC-7009				KN-621	
700	Wildcat Sport	15-16	AC-7014				KN-621	
700	Wildcat Sport LTD	15-16					KN-621	
700	Wildcat Sport XT	15-16					KN-621	
700	Wildcat Trail	14	AC-7014					
700	Wildcat Trail	15-16	AC-7014				KN-621	
700	Wildcat Trail LTD	15-16					KN-621	
700	Wildcat Trail SE	16	AC-7014				KN-621	
700	Wildcat Trail XT	14	AC-7014					
700	Wildcat Trail XT	15	AC-7014				KN-621	
700	Wildcat Trail XT	16					KN-621	
700	XTX700i Prowler 4X4	12	AC-7009				KN-621	
700	XTX700i Prowler 4X4 HDX	12	AC-7009				KN-621	
951	1000 LTD	11	AC-1009					
951	1000 MudPro EFI H2 4x4 Auto	10-11	AC-1009					
951	1000 XT	13-14	AC-1009				KN-621	
951	1000 XT	15-16					KN-621	
951	1000i GT	12	AC-1009					
951	1000S	11	AC-1009					
951	MudPro 1000	11	AC-1009					
951	MudPro 1000 LTD	12-14	AC-1009				KN-621	
951	MudPro 1000 LTD	15					KN-621	
951	MudPro 1000 SE	16					KN-621	
951	Prowler XTZ 1000	14	AC-7009				KN-621	
951	Prowler XTZ 1000 H2 EFI	09-11	AC-7009				KN-621	
951	Prowler XTZ 1000i	13	AC-7009				KN-621	
951	Thundercat	09	AC-1009				KN-621	
951	TRV1000	12	AC-1009				KN-621	
951	TRV1000 EFI Cruiser	11	AC-1009				KN-621	
951	TRV1000 H2 EFI	10	AC-1009				KN-621	
951	TRV1000 H2 EFI Cruiser	09	AC-1009				KN-621	
951	TRV1000 LTD	13-14	AC-1009				KN-621	
951	TRV1000 LTD	15					KN-621	
951	TRV1000 XT	15					KN-621	
951	TRV1000 XT L7e	16					KN-621	
951	Wildcat 4X	14	AC-1012	AC-1012DK			KN-621	
951	Wildcat 4X	15-16					KN-621	
951	Wildcat 4X LTD	14	AC-1012	AC-1012DK			KN-621	
951	Wildcat 4X LTD	15					KN-621	
951	Wildcat X	16	AC-1012	AC-1012DK			KN-621	
951	Wildcat X 1000	13-15	AC-1012	AC-1012DK			KN-621	
951	Wildcat X LTD	14-16	AC-1012	AC-1012DK			KN-621	

2) Requires Two; 3) Requires Three; 4) Requires Four. The use of custom air filter requires removal of air box. Some custom filters and intakes are not legal for sale or use on any pollution controlled motor vehicle in California or states adopting California emission procedures. See knfilters.com for CARB status on each part for a specific vehicle.



ATV - Application Listing

CC	Model	Year	Air Filter	Air Filter Precharger	Custom	Custom Precharger	Oil Filter	Comments
ARCTIC CAT								
951	Wildcat X SE	16	AC-1012	AC-1012DK			KN-621	
951	Wildcat X Special Edition	16	AC-1012	AC-1012DK			KN-621	
951	XTZ1000i Prowler	12	AC-7009					
952	Prowler XT 1000	16					KN-621	
1000	Thundercat	08	AC-1009				KN-621	
1000	Thundercat 1000 H2	10	AC-1009				KN-621	
1000	Wildcat 1000	12	AC-1012	AC-1012DK				
1000	Wildcat 1000	13-14	AC-1012	AC-1012DK			KN-621	
1000	Wildcat 1000	15					KN-621	
1000	Wildcat 1000 LTD	13-14	AC-1012	AC-1012DK			KN-621	
1000	Wildcat 4 1000	13-14	AC-1012	AC-1012DK			KN-621	
1000	Wildcat 4 LTD	14	AC-1012	AC-1012DK			KN-621	
BOMBARDIER								
330	Outlander 330 HO 2x4	03-05	BD-3303	RU-0510PK			KN-152	
330	Outlander 330 HO 2x4	06					KN-152	
330	Outlander 330 HO 4x4	03-05	BD-3303	RU-0510PK			KN-152	
330	Outlander 330 HO 4x4	06					KN-152	
400	Outlander 400 HO 2x4	03-04	BD-3303	RU-0510PK			KN-152	
400	Outlander 400 HO 4x4	03-06	BD-3303	RU-0510PK			KN-152	
400	Outlander 400 HO 4x4 XT	03-06	BD-3303	RU-0510PK			KN-152	
400	Outlander Max 400 HO	06	BD-3303	RU-0510PK			KN-152	
400	Outlander Max 400 HO XT	04-06	BD-3303	RU-0510PK			KN-152	
403	Outlander Max 400 HO	04-05	BD-3303	RU-0510PK			KN-152	
495	Quest 500	03					KN-556	
495	Quest 500	04	BD-6502	22-8013PK			KN-556	
498	Traxter 500	99-00					KN-557	
498	Traxter 500 Auto	04	BD-6502	22-8013PK			KN-557	
498	Traxter 500 Auto CVT	05	BD-6502	22-8013PK			KN-556	
498	Traxter 500 Autoshift	02-03	BD-6502	22-8013PK			KN-557	
498	Traxter 500 XL	00-01					KN-557	
498	Traxter 500 XL	03-04	BD-6502	22-8013PK			KN-557	
498	Traxter Max 500	03-04	BD-6502	22-8013PK			KN-557	
500	Traxter 500	03-04					KN-557	
500	Traxter 500 5 Speed	05	BD-6502	22-8013PK			KN-557	
500	Traxter 500 Auto XT	04	BD-6502	22-8013PK			KN-557	
500	Traxter 500 Autoshift	01	BD-6502	22-8013PK			KN-557	
500	Traxter 500 Autoshift XT	03	BD-6502	22-8013PK			KN-557	
500	Traxter 500 Footshift	01	BD-6502	22-8013PK			KN-557	
500	Traxter 500 XL	99					KN-557	
500	Traxter 500 XL	02					KN-557	
500	Traxter 500 XL	05	BD-6502	22-8013PK			KN-557	
500	Traxter 500 XT	99-00					KN-557	
500	Traxter 500 XT	01-02	BD-6502	22-8013PK			KN-557	
500	Traxter 500 XT	03-04					KN-557	
500	Traxter 500 XT	05	BD-6502	22-8013PK			KN-557	
500	Traxter Max 500	05	BD-6502	22-8013PK			KN-557	
500	Traxter Max 500 XT	04-05	BD-6502	22-8013PK			KN-557	
644	DS650	00	BD-6500	YA-3502DK			KN-151	
644	DS650	01-03	BD-6500	YA-3502DK			KN-152	
644	DS650 Baja	02-03	BD-6500	YA-3502DK			KN-152	
644	DS650 Racer	00	BD-6500	YA-3502DK			KN-151	
644	DS650 Racer	01-03	BD-6500	YA-3502DK			KN-152	
644	DS650X	05-06	BD-6500	YA-3502DK			KN-152	
644	Quest 650	02-04	BD-6502	22-8013PK			KN-556	
650	DS650	04-05	BD-6500	YA-3502DK			KN-152	

2) Requires Two; 3) Requires Three; 4) Requires Four. The use of custom air filter requires removal of air box. Some custom filters and intakes are not legal for sale or use on any pollution controlled motor vehicle in California or states adopting California emission procedures. See knfilters.com for CARB status on each part for a specific vehicle.

ATV - Application Listing



CC	Model	Year	Air Filter	Air Filter Precharger	Custom	Custom Precharger	Oil Filter	Comments
BOMBARDIER								
650	DS650	06					KN-152	
650	DS650 Baja	04	BD-6500	YA-3502DK			KN-152	
650	DS650 Baja X	04	BD-6500	YA-3502DK			KN-152	
650	Outlander 650 HO 4x4 EFI XT	06	BD-6506	22-8016PK			KN-152	
650	Outlander 650 HO EFI 4x4	06	BD-6506	22-8016PK			KN-152	
650	Outlander Max 650 HO EFI 4x4	06	BD-6506	22-8016PK			KN-152	
650	Outlander Max 650 HO EFI 4x4 XT	06	BD-6506	22-8016PK			KN-152	
650	Outlander Max 650 HO EFI XT	06	BD-6506	22-8016PK			KN-152	
650	Quest 650 Max	04	BD-6502	22-8013PK			KN-556	
650	Quest 650 XT	02-03					KN-556	
650	Traxter 650 Auto CVT	05	BD-6502	22-8013PK			KN-556	
650	Traxter 650 Auto CVT XT	05	BD-6502	22-8013PK			KN-556	
650	Traxter Max 650 Auto CVT	05	BD-6502	22-8013PK			KN-556	
650	Traxter Max 650 Auto CVT XT	05	BD-6502	22-8013PK			KN-556	
800	Outlander 800 HO 4x4 EFI	06	BD-6506	22-8016PK			KN-152	
800	Outlander 800 HO 4x4 EFI XT	06	BD-6506	22-8016PK			KN-152	
800	Outlander Max 800 HO EFI 4x4	06	BD-6506	22-8016PK			KN-152	
800	Outlander Max 800 HO EFI 4x4 XT	06	BD-6506	22-8016PK			KN-152	
CAN-AM								
400	Outlander 400 EFI	11-12					KN-152	
400	Outlander 400 EFI	14					KN-152	
400	Outlander 400 EFI XT	11-12					KN-152	
400	Outlander 400 EFI XT	14					KN-152	
400	Outlander 400 HO	07-08	BD-3303	RU-0510PK			KN-152	
400	Outlander 400 HO EFI	08-10					KN-152	
400	Outlander 400 HO EFI XT	08-10					KN-152	
400	Outlander 400 HO XT	07-08	BD-3303	RU-0510PK			KN-152	
400	Outlander Max 400 EFI	09-12					KN-152	
400	Outlander Max 400 EFI	14					KN-152	
400	Outlander Max 400 EFI XT	09-12					KN-152	
400	Outlander Max 400 EFI XT	14					KN-152	
400	Outlander Max 400 HO	07-08	BD-3303	RU-0510PK			KN-152	
400	Outlander Max 400 HO EFI	08					KN-152	
400	Outlander Max 400 HO EFI XT	08					KN-152	
400	Outlander Max 400 HO XT	07-08	BD-3303	RU-0510PK			KN-152	
450	DS450	08-09	CM-4508	CM-4508DK			KN-560	
450	DS450	14	CM-4508	CM-4508DK			KN-560	
450	DS450 EFI	09-12	CM-4508	CM-4508DK			KN-560	
450	DS450 EFI X mx	09-13	CM-4508	CM-4508DK			KN-560	
450	DS450 EFI X xc	09-12	CM-4508	CM-4508DK			KN-560	
450	DS450 X mx	14-15	CM-4508	CM-4508DK			KN-560	
450	DS450 X xc	14-15	CM-4508	CM-4508DK			KN-560	
450	DS450X	08	CM-4508	CM-4508DK			KN-560	
450	Outlander L 450	15-16	CM-8012				KN-152	
450	Outlander L 450 DPS	15-16	CM-8012				KN-152	
450	Outlander L Max 450	15-16	CM-8012				KN-152	
450	Outlander L Max 450 DPS	15-16	CM-8012				KN-152	
500	Outlander 500 EFI	10-12	BD-6506	22-8016PK			KN-152	
500	Outlander 500 EFI	13-14	CM-8012				KN-152	
500	Outlander 500 EFI DPS	13-15	CM-8012				KN-152	
500	Outlander 500 EFI XT	10-12	BD-6506	22-8016PK			KN-152	
500	Outlander 500 EFI XT	13-15	CM-8012				KN-152	
500	Outlander 500 HO 4x4 EFI	07-09	BD-6506	22-8016PK			KN-152	
500	Outlander 500 HO 4x4 EFI XT	07-09	BD-6506	22-8016PK			KN-152	
500	Outlander L 500	15	CM-8012				KN-152	

2) Requires Two; 3) Requires Three; 4) Requires Four. The use of custom air filter requires removal of air box. Some custom filters and intakes are not legal for sale or use on any pollution controlled motor vehicle in California or states adopting California emission procedures. See knfilters.com for CARB status on each part for a specific vehicle.



ATV - Application Listing

CC	Model	Year	Air Filter	Air Filter Precharger	Custom	Custom Precharger	Oil Filter	Comments
CAN-AM								
500	Outlander L 500 DPS	15	CM-8012				KN-152	
500	Outlander L Max 500	15	CM-8012				KN-152	
500	Outlander L Max 500 DPS	15	CM-8012				KN-152	
500	Outlander Max 500 EFI	09	BD-6506	22-8016PK			KN-152	
500	Outlander Max 500 EFI	11-12	BD-6506	22-8016PK			KN-152	
500	Outlander Max 500 EFI	13-14	CM-8012				KN-152	
500	Outlander Max 500 EFI DPS	13-15	CM-8012				KN-152	
500	Outlander Max 500 EFI XT	09-12	BD-6506	22-8016PK			KN-152	
500	Outlander Max 500 EFI XT	13-15	CM-8012				KN-152	
500	Outlander Max 500 HO EFI	07-08	BD-6506	22-8016PK			KN-152	
500	Outlander Max 500 HO EFI	10	BD-6506	22-8016PK			KN-152	
500	Outlander Max 500 HO EFI LTD	10	BD-6506	22-8016PK			KN-152	
500	Outlander Max 500 HO EFI XT	07-08	BD-6506	22-8016PK			KN-152	
500	Renegade 500	08-12	BD-6506	22-8016PK			KN-152	
500	Renegade 500	13-15	CM-8012				KN-152	
570	Outlander 570 DPS	16	CM-8012				KN-152	
570	Outlander 570 XT	16	CM-8012				KN-152	
570	Outlander L 500 DPS	16					KN-152	
570	Outlander L 570	16	CM-8012				KN-152	
570	Outlander L 570 DPS	16	CM-8012				KN-152	
570	Outlander L 570 LE	16	CM-8012				KN-152	
570	Outlander L 570 Mossy Oak Hunting Edition	16	CM-8012				KN-152	
570	Outlander L 570 X mr	16					KN-152	
570	Outlander L Max 570	16	CM-8012				KN-152	
570	Outlander L Max 570 DPS	16	CM-8012				KN-152	
570	Outlander LX MR 570	16	CM-8012				KN-152	
570	Outlander Max 570 DPS	16	CM-8012				KN-152	
570	Outlander Max 570 XT	16	CM-8012				KN-152	
570	Outlander Mossy Oak Hunting 570	16					KN-152	
570	Renegade 570	16	CM-8012				KN-152	
650	DS650X	07	BD-6500	YA-3502DK			KN-152	
650	Outlander 650 6x6 XT	15-16	CM-8012				KN-152	
650	Outlander 650 EFI	09	BD-6506	22-8016PK			KN-152	
650	Outlander 650 EFI	10-12					KN-152	
650	Outlander 650 EFI	13-16	CM-8012				KN-152	
650	Outlander 650 EFI DPS	13-16	CM-8012				KN-152	
650	Outlander 650 EFI XT	09	BD-6506	22-8016PK			KN-152	
650	Outlander 650 EFI XT	11-12					KN-152	
650	Outlander 650 EFI XT	13-16	CM-8012				KN-152	
650	Outlander 650 EFI XT-P	11					KN-152	
650	Outlander 650 HO 4x4 EFI XT	07-08	BD-6506	22-8016PK			KN-152	
650	Outlander 650 HO EFI 4x4	07-08	BD-6506	22-8016PK			KN-152	
650	Outlander 650 X mr	13-16	CM-8012				KN-152	
650	Outlander Max 650 EFI	09	BD-6506	22-8016PK			KN-152	
650	Outlander Max 650 EFI	10-12					KN-152	
650	Outlander Max 650 EFI	13-15	CM-8012				KN-152	
650	Outlander Max 650 EFI DPS	13-16	CM-8012				KN-152	
650	Outlander Max 650 EFI XT	09	BD-6506	22-8016PK			KN-152	
650	Outlander Max 650 EFI XT	10-12					KN-152	
650	Outlander Max 650 EFI XT	13-16	CM-8012				KN-152	
650	Outlander Max 650 EFI XT-P	11-12					KN-152	
650	Outlander Max 650 HO EFI	07-08	BD-6506	22-8016PK			KN-152	
650	Outlander Max 650 HO EFI XT	07-08	BD-6506	22-8016PK			KN-152	
800	Commander 800R	11-16	CM-8011				KN-152	
800	Commander 800R	17	CM-8011					

2) Requires Two; 3) Requires Three; 4) Requires Four. The use of custom air filter requires removal of air box. Some custom filters and intakes are not legal for sale or use on any pollution controlled motor vehicle in California or states adopting California emission procedures. See knfilters.com for CARB status on each part for a specific vehicle.

ATV - Application Listing



CC	Model	Year	Air Filter	Air Filter Precharger	Custom	Custom Precharger	Oil Filter	Comments
CAN-AM								
800	Commander 800R DPS	14-16	CM-8011				KN-152	
800	Commander 800R DPS	17	CM-8011					
800	Commander 800R XT	11-16	CM-8011				KN-152	
800	Commander 800R XT	17	CM-8011					
800	Commander Max 800R DPS	16					KN-152	
800	Defender DPS HD8	16	CM-8016				KN-152	
800	Defender DPS HD8	17	CM-8016					
800	Defender HD8	16	CM-8016				KN-152	
800	Defender HD8	17	CM-8016					
800	Defender Max HD8 DPS	17	CM-8016					
800	Defender Max HD8 XT	17	CM-8016					
800	Defender XT HD8	16	CM-8016				KN-152	
800	Defender XT HD8	17	CM-8016					
800	Outlander 800 HO 4x4 EFI	07-08	BD-6506	22-8016PK			KN-152	
800	Outlander 800 HO 4x4 EFI XT	07-08	BD-6506	22-8016PK			KN-152	
800	Outlander 800R EFI	09-11					KN-152	
800	Outlander 800R EFI	12-15	CM-8012				KN-152	
800	Outlander 800R EFI DPS	13-15	CM-8012				KN-152	
800	Outlander 800R EFI X mr	12					KN-152	
800	Outlander 800R EFI X mr	13	CM-8012				KN-152	
800	Outlander 800R EFI X mr	15	CM-8012				KN-152	
800	Outlander 800R EFI XT	09-11					KN-152	
800	Outlander 800R EFI XT	12-15	CM-8012				KN-152	
800	Outlander 800R EFI XT-P	11					KN-152	
800	Outlander 800R EFI XT-P	13-15	CM-8012				KN-152	
800	Outlander Max 800 HO EFI	07-08	BD-6506	22-8016PK			KN-152	
800	Outlander Max 800 HO EFI LTD	07-08	BD-6506	22-8016PK			KN-152	
800	Outlander Max 800 HO EFI XT	07-08	BD-6506	22-8016PK			KN-152	
800	Outlander Max 800R EFI	09-12					KN-152	
800	Outlander Max 800R EFI DPS	13-15	CM-8012				KN-152	
800	Outlander Max 800R EFI LTD	09					KN-152	
800	Outlander Max 800R EFI LTD	11-12					KN-152	
800	Outlander Max 800R EFI XT	09-12					KN-152	
800	Outlander Max 800R EFI XT	13-15	CM-8012				KN-152	
800	Outlander Max 800R EFI XT-P	11-12					KN-152	
800	Outlander Max 800R EFI XT-P	13-15	CM-8012				KN-152	
800	Renegade 800	07-08	BD-6506	22-8016PK			KN-152	
800	Renegade 800	09-10					KN-152	
800	Renegade 800 X	08	BD-6506	22-8016PK			KN-152	
800	Renegade 800 X	09-10					KN-152	
800	Renegade 800 X xc	10-11					KN-152	
800	Renegade 800R	10-11					KN-152	
800	Renegade 800R	12-15	CM-8012				KN-152	
800	Renegade 800R EFI X xc	12	CM-8012				KN-152	
800	Renegade 800R X xc	10-11					KN-152	
800	Renegade 800R X xc	12-15	CM-8012				KN-152	
850	Outlander Max 850 XT	16	CM-8012				KN-152	
850	Outlander Max 850 XT-P	16	CM-8012				KN-152	
850	Renegade 850	16	CM-8012				KN-152	
850	Renegade 850 X xc	16	CM-8012				KN-152	
854	Outlander 850 DPS	16	CM-8012				KN-152	
854	Outlander 850 X mr	16	CM-8012				KN-152	
854	Outlander 850 XT	16	CM-8012				KN-152	
854	Outlander 850 XT-P	16	CM-8012				KN-152	
976	Commander 1000	11-12	CM-8011				KN-152	

2) Requires Two; 3) Requires Three; 4) Requires Four. The use of custom air filter requires removal of air box. Some custom filters and intakes are not legal for sale or use on any pollution controlled motor vehicle in California or states adopting California emission procedures. See knfilters.com for CARB status on each part for a specific vehicle.



ATV - Application Listing

CC	Model	Year	Air Filter	Air Filter Precharger	Custom	Custom Precharger	Oil Filter	Comments
CAN-AM								
976	Commander 1000	13	CM-8011				KN-152	
976	Commander 1000	14	CM-8011				KN-152	
976	Commander 1000 DPS	13-16	CM-8011				KN-152	
976	Commander 1000 DPS	17	CM-8011					
976	Commander 1000 LTD	12-16	CM-8011				KN-152	
976	Commander 1000 LTD	17	CM-8011					
976	Commander 1000 Mossy Oak Hunting Edition	16	CM-8011				KN-152	
976	Commander 1000 Mossy Oak Hunting Edition	17	CM-8011					
976	Commander 1000 X	11-13	CM-8011				KN-152	
976	Commander 1000 XT	11-16	CM-8011				KN-152	
976	Commander 1000 XT	17	CM-8011					
976	Commander 1000 XT-P	13-16	CM-8011				KN-152	
976	Commander 1000 XT-P	17	CM-8011					
976	Commander Max 1000 DPS	14-16	CM-8011				KN-152	
976	Commander Max 1000 LTD	15	CM-8011					
976	Commander Max 1000 LTD	16	CM-8011				KN-152	
976	Commander Max 1000 XT	14-16	CM-8011				KN-152	
976	Defender DPS HD10	16	CM-8016				KN-152	
976	Defender DPS HD10	17	CM-8016					
976	Defender HD10	16	CM-8016				KN-152	
976	Defender HD10	17	CM-8016					
976	Defender HD10 Mossy Oak Hunting Ed.	17	CM-8016					
976	Defender Max HD10 DPS	17	CM-8016					
976	Defender Max HD10 XT	17	CM-8016					
976	Defender XT Cab HD10	16	CM-8016				KN-152	
976	Defender XT Cab HD10	17	CM-8016					
976	Defender XT HD10	16	CM-8016				KN-152	
976	Defender XT HD10	17	CM-8016					
976	Defender XT HD100	17	CM-8016					
976	Maverick 1000R	13	CM-8011					
976	Maverick 1000R	14	CM-8011				KN-152	
976	Maverick 1000R	15-16	CM-8011		63-1135		KN-152	
976	Maverick 1000R DPS	16	CM-8011		63-1135		KN-152	
976	Maverick 1000R DPS	17	CM-8011					
976	Maverick 1000R Turbo	16	CM-9715				KN-152	
976	Maverick 1000R Turbo	17	CM-9715		63-1140			
976	Maverick 1000R Turbo X ds	15-16	CM-9715		63-1140		KN-152	
976	Maverick 1000R Turbo X ds	17	CM-9715		63-1140			
976	Maverick 1000R Turbo X rs	16	CM-9715		63-1140		KN-152	
976	Maverick 1000R Turbo X rs	17	CM-9715		63-1140			
976	Maverick 1000R X ds	15	CM-8011*		63-1135		KN-152	*Exc. Turbo
976	Maverick 1000R X ds	16	CM-8011		63-1135		KN-152	
976	Maverick 1000R X mr DPS	15-16	CM-8011		63-1135		KN-152	
976	Maverick 1000R X rs DPS	15	CM-8011		63-1135		KN-152	
976	Maverick 1000R X xc	17	CM-8011					
976	Maverick 1000R X xc DPS	15-16	CM-8011		63-1135		KN-152	
976	Maverick 1000R XC	16	CM-8011		63-1135		KN-152	
976	Maverick 1000R XC	17	CM-8011					
976	Maverick Max 1000R	14	CM-8011				KN-152	
976	Maverick Max 1000R	15-16	CM-8011		63-1135		KN-152	
976	Maverick Max 1000R DPS	16	CM-8011		63-1135		KN-152	
976	Maverick Max 1000R DPS	17	CM-8011					
976	Maverick Max 1000R Turbo	16	CM-9715				KN-152	
976	Maverick Max 1000R Turbo	17	CM-9715					
976	Maverick Max 1000R Turbo X ds	15	CM-9715		63-1140		KN-152	

2) Requires Two; 3) Requires Three; 4) Requires Four. The use of custom air filter requires removal of air box. Some custom filters and intakes are not legal for sale or use on any pollution controlled motor vehicle in California or states adopting California emission procedures. See knfilters.com for CARB status on each part for a specific vehicle.

ATV - Application Listing



CC	Model	Year	Air Filter	Air Filter Precharger	Custom	Custom Precharger	Oil Filter	Comments
CAN-AM								
976	Maverick Max 1000R Turbo X ds	16	CM-9715				KN-152	
976	Maverick Max 1000R Turbo X ds	17	CM-9715					
976	Maverick Max 1000R Turbo X rs	16	CM-9715				KN-152	
976	Maverick Max 1000R Turbo X rs	17	CM-9715					
976	Maverick Max 1000R X ds	15	CM-8011*		63-1135		KN-152	*Exc. Turbo
976	Maverick Max 1000R X ds	16	CM-8011		63-1135		KN-152	
976	Maverick Max 1000R X mr	17	CM-8011					
976	Maverick Max 1000R X rs DPS	15	CM-8011		63-1135		KN-152	
976	Maverick Max X rs DPS 1000R	14	CM-8011				KN-152	
976	Maverick X mr 1000R	14	CM-8011				KN-152	
976	Maverick X rs 1000R	13	CM-8011					
976	Maverick X rs 1000R	14	CM-8011				KN-152	
976	Maverick X rs DPS 1000R	14	CM-8011				KN-152	
976	Maverick X xc DPS 1000R	14	CM-8011				KN-152	
976	Renegade 1000	12-16	CM-8012				KN-152	
976	Renegade 1000 EFI X xc	12	CM-8012				KN-152	
976	Renegade 1000 X mr	16	CM-8012				KN-152	
976	Renegade 1000 X xc	13-16	CM-8012				KN-152	
1000	Outlander 1000 6x6 XT	15-16	CM-8012				KN-152	
1000	Outlander 1000 EFI	12	CM-8012				KN-152	
1000	Outlander 1000 EFI DPS	13-16	CM-8012				KN-152	
1000	Outlander 1000 EFI XT	12-16	CM-8012				KN-152	
1000	Outlander 1000 EFI XT-P	13-16	CM-8012				KN-152	
1000	Outlander 1000 X mr	13-15	CM-8012				KN-152	
1000	Outlander 1000 X mr	16					KN-152	
1000	Outlander Max 1000 EFI DPS	13-15	CM-8012				KN-152	
1000	Outlander Max 1000 EFI LTD	13-16	CM-8012				KN-152	
1000	Outlander Max 1000 EFI X mr	15	CM-8012				KN-152	
1000	Outlander Max 1000 EFI XT	13-16	CM-8012				KN-152	
1000	Outlander Max 1000 EFI XT-P	13-16	CM-8012				KN-152	
CANNONDALE								
440	440	02	CD-4402					
GAS GAS								
450	Wild HP 450	04-05					KN-112	
GILERA								
250	Oregon	07-08					KN-183	
HONDA								
90	ATC90	73-78			R-1100	22-8048PK		
90	TRX90	93-06	HA-1088	22-8008PK				
90	TRX90EX	07-08	HA-1088	22-8008PK				
90	TRX90X	09	HA-1088	22-8008PK				
90	TRX90X	12-16	HA-1088	22-8008PK				
110	ATC110	82			R-1100	22-8048PK		
110	ATC110	83-85	HA-0510	RU-0510PK				
110	ATC110	83-85	HA-0510	RU-0510PL				
110	ATC110	83-85	HA-0510	RU-0510PR				
110	ATC110	83-85	HA-0510	RU-0510PY				
125	ATC125M	84-85	HA-0510	RU-0510PK				
125	ATC125M	84-85	HA-0510	RU-0510PL				
125	ATC125M	84-85	HA-0510	RU-0510PR				
125	ATC125M	84-85	HA-0510	RU-0510PY				
125	ATC125M	86-87					KN-566	
125	TRX125	85-86	HA-0510	RU-0510PK				
125	TRX125	85-86	HA-0510	RU-0510PL				
125	TRX125	85-86	HA-0510	RU-0510PR				

2) Requires Two; 3) Requires Three; 4) Requires Four. The use of custom air filter requires removal of air box. Some custom filters and intakes are not legal for sale or use on any pollution controlled motor vehicle in California or states adopting California emission procedures. See knfilters.com for CARB status on each part for a specific vehicle.



ATV - Application Listing

CC	Model	Year	Air Filter	Air Filter Precharger	Custom	Custom Precharger	Oil Filter	Comments
HONDA								
125	TRX125	85-86	HA-0510	RU-0510PY				
125	TRX125	87-88	HA-0510	RU-0510PK			KN-566	
125	TRX125	87-88	HA-0510	RU-0510PL			KN-566	
125	TRX125	87-88	HA-0510	RU-0510PR			KN-566	
125	TRX125	87-88	HA-0510	RU-0510PY			KN-566	
185	ATC185	80			RU-0160	22-8009PK		
185	ATC185S	81-82			RU-0160	22-8009PK		
185	ATC185S	83	HA-0510	RU-0510PK				
185	ATC185S	83	HA-0510	RU-0510PL				
185	ATC185S	83	HA-0510	RU-0510PR				
185	ATC185S	83	HA-0510	RU-0510PY				
199	TRX200D Fourtrax	90					KN-113	
199	TRX200D Fourtrax	91-97	HA-2090	HA-2090PR			KN-113	
200	ATC200	81			RU-0160	22-8009PK		
200	ATC200E Big Red	82-83	HA-0510	RU-0510PK				
200	ATC200E Big Red	82-83	HA-0510	RU-0510PL				
200	ATC200E Big Red	82-83	HA-0510	RU-0510PR				
200	ATC200E Big Red	82-83	HA-0510	RU-0510PY				
200	ATC200ES Big Red	84	HA-0510	RU-0510PK				
200	ATC200ES Big Red	84	HA-0510	RU-0510PL				
200	ATC200ES Big Red	84	HA-0510	RU-0510PR				
200	ATC200ES Big Red	84	HA-0510	RU-0510PY				
200	ATC200M	84-85	HA-0510	RU-0510PK				
200	ATC200M	84-85	HA-0510	RU-0510PL				
200	ATC200M	84-85	HA-0510	RU-0510PR				
200	ATC200M	84-85	HA-0510	RU-0510PY				
200	ATC200S	84-86	HA-0510	RU-0510PK				
200	ATC200S	84-86	HA-0510	RU-0510PL				
200	ATC200S	84-86	HA-0510	RU-0510PR				
200	ATC200S	84-86	HA-0510	RU-0510PY				
200	ATC200X	83-85	HA-2420					
200	TRX200SX Fourtrax	86-88	HA-0510	RU-0510PK				
200	TRX200SX Fourtrax	86-88	HA-0510	RU-0510PL				
200	TRX200SX Fourtrax	86-88	HA-0510	RU-0510PR				
200	TRX200SX Fourtrax	86-88	HA-0510	RU-0510PY				
225	TRX250 Recon	97-98	HA-2597	YA-3504PK				
225	TRX250EX	01-08	HA-2501	YA-3504PK				
250	ATC250ES Big Red	85-87					KN-112	
250	ATC250R	81-82			RU-1780	25-1770		
250	ATC250R	81-82			RU-1780	RU-0510PK		
250	ATC250R	81-82			RU-1780	RU-0510PL		
250	ATC250R	81-82			RU-1780	RU-0510PR		
250	ATC250R	81-82			RU-1780	RU-0510PY		
250	ATC250R	83-84	HA-2410	RU-1460PK	RC-2530	25-3918		
250	ATC250R	85-86	HA-2440	HA-2440PR				
250	ATC250SX	85-87	HA-2410	RU-1460PK			KN-113	
250	FL250 Odyssey	77-84	HA-1294		56-2000	E-3461PK		
250	FL250 Odyssey	77-84	HA-1294		56-2000	E-3461PR		
250	FL250 Odyssey	77-84	HA-1294		56-2000	E-3461PY		
250	TRX250	85-86	HA-2410	RU-1460PK			KN-112	
250	TRX250	87					KN-113	
250	TRX250 Fourtrax	87	HA-2410	RU-1460PK			KN-112	
250	TRX250 Recon	99-01	HA-2597	YA-3504PK				
250	TRX250R	86	HA-4250	HA-4250PR				
250	TRX250R Fourtrax	87-89	HA-4250	HA-4250PR				

2) Requires Two; 3) Requires Three; 4) Requires Four. The use of custom air filter requires removal of air box. Some custom filters and intakes are not legal for sale or use on any pollution controlled motor vehicle in California or states adopting California emission procedures. See knfilters.com for CARB status on each part for a specific vehicle.

ATV - Application Listing



CC	Model	Year	Air Filter	Air Filter Precharger	Custom	Custom Precharger	Oil Filter	Comments
HONDA								
250	TRX250TE Recon ES	02-09	HA-2501	YA-3504PK				
250	TRX250TE Recon ES	11-14	HA-2501	YA-3504PK				
250	TRX250TM Recon	02-09	HA-2501	YA-3504PK				
250	TRX250TM Recon	11-14	HA-2501	YA-3504PK				
250	TRX250X	87-88	HA-2504	HA-2504PR			KN-112	
250	TRX250X	89-90					KN-113	
250	TRX250X	91-92	HA-2504	HA-2504PR			KN-112	
250	TRX250X	09	HA-2501	YA-3504PK				
250	TRX250X	11-17	HA-2501	YA-3504PK				
280	TRX300 Fourtrax	90-97	HA-3093	HA-3093PR			KN-113	
280	TRX300 Fourtrax	98-01	HA-3098	HA-3098PR			KN-113	
282	TRX300X	09	HA-3094	HA-3094PR			KN-113	
300	TRX300 Fourtrax	88-89	HA-3093	HA-3093PR			KN-113	
300	TRX300EX	93-08	HA-3094	HA-3094PR			KN-113	
300	TRX300FW Fourtrax 4x4	87					KN-113	
300	TRX300FW Fourtrax 4x4	88-97	HA-3093	HA-3093PR			KN-113	
300	TRX300FW Fourtrax 4x4	98-00	HA-3098	HA-3098PR			KN-113	
300	TRX300FW Fourtrax 4x4	01					KN-113	
325	TRX350TM Rancher	02-05	HA-3500	HA-3500PR			KN-113	
350	ATC350X	85-86	HA-3350	HA-3094PR			KN-113	
350	FL350R Odyssey	85	HA-4350					
350	TRX350 EX Sportrax	02					KN-113	
350	TRX350 Fourtrax 4x4	86-87	HA-4435				KN-113	
350	TRX350D Foreman 4x4	87-89	HA-4435				KN-113	
350	TRX350FE Rancher 4x4 ES	00-06	HA-3500	HA-3500PR			KN-113	
350	TRX350FM Rancher 4x4	00-06	HA-3500	HA-3500PR			KN-113	
350	TRX350TE Rancher ES	00-06	HA-3500	HA-3500PR			KN-113	
350	TRX350TM Rancher	00-01	HA-3500	HA-3500PR			KN-113	
350	TRX350TM Rancher	06	HA-3500	HA-3500PR			KN-113	
395	TRX400FW Foreman 4x4	95-97	HA-3093	HA-3093PR			KN-113	
395	TRX400FW Foreman 4x4	98-03	HA-3098	HA-3098PR			KN-113	
397	TRX400EX	99-08	HA-4099	22-8016PK	HA-4099-T	HA-4099-TDK	KN-113	
397	TRX400EX	99-08	HA-4099	22-8016PK	HA-4099-T	HA-4099-TPK	KN-113	
397	TRX400FGA Rancher AT GPScape	04-07	HA-3500	HA-3500PR			KN-111	
400	FL400R Pilot	89-90	HA-4400	HA-4400PR				
400	TRX400FA Rancher AT	04-07	HA-3500	HA-3500PR			KN-111	
400	TRX400X	09	HA-4099	22-8016PK	HA-4099-T	HA-4099-TDK	KN-113	
400	TRX400X	09	HA-4099	22-8016PK	HA-4099-T	HA-4099-TPK	KN-113	
400	TRX400X	12-14	HA-4099	22-8016PK	HA-4099-T	HA-4099-TDK	KN-113	
400	TRX400X	12-14	HA-4099	22-8016PK	HA-4099-T	HA-4099-TPK	KN-113	
420	TRX420FA Rancher AT	09-13	HA-4207				KN-114	
420	TRX420FA Rancher AT	14	HA-5000	HA-5000PK			KN-114	
420	TRX420FA1 FourTrax Rancher 4x4 AT DCT	14-16	HA-5000	HA-5000PK			KN-114	
420	TRX420FA2 FourTrax Rancher 4x4 AT DCT w/EPS	14-16	HA-5000	HA-5000PK			KN-114	
420	TRX420FA2 FourTrax Rancher 4x4 AT DCT w/EPS	17	HA-5000	HA-5000PK				
420	TRX420FA5 FourTrax Rancher 4x4 Auto DCT IRS	15-16	HA-5000	HA-5000PK			KN-114	
420	TRX420FA5 FourTrax Rancher 4x4 Auto DCT IRS	17	HA-5000	HA-5000PK				
420	TRX420FA6 FourTrax Rancher 4x4 Auto DCT IRS EPS	15-16	HA-5000	HA-5000PK			KN-114	
420	TRX420FA6 FourTrax Rancher 4x4 Auto DCT IRS EPS	17	HA-5000	HA-5000PK				
420	TRX420FE FourTrax Rancher 4X4 ES	07-13	HA-4207				KN-113*	*w/Manual Trans.
420	TRX420FE1 FourTrax Rancher 4x4 ES	14	HA-5000	HA-5000PK			KN-113*	*w/Manual Trans.

2) Requires Two; 3) Requires Three; 4) Requires Four. The use of custom air filter requires removal of air box. Some custom filters and intakes are not legal for sale or use on any pollution controlled motor vehicle in California or states adopting California emission procedures. See knfilters.com for CARB status on each part for a specific vehicle.



ATV - Application Listing

CC	Model	Year	Air Filter	Air Filter Precharger	Custom	Custom Precharger	Oil Filter	Comments
HONDA								
420	TRX420FE1 FourTrax Rancher 4x4 ES	15-16	HA-5000	HA-5000PK			KN-113	
420	TRX420FE1 FourTrax Rancher 4x4 ES	17	HA-5000	HA-5000PK				
420	TRX420FM FourTrax Rancher 4X4	07-13	HA-4207				KN-113*	*w/Manual Trans.
420	TRX420FM1 FourTrax Rancher 4x4	14	HA-5000	HA-5000PK			KN-113*	*w/Manual Trans.
420	TRX420FM1 FourTrax Rancher 4x4	15-16	HA-5000	HA-5000PK			KN-113	
420	TRX420FM1 FourTrax Rancher 4x4	17	HA-5000	HA-5000PK				
420	TRX420FM2 FourTrax Rancher 4x4 w/EPS	14	HA-5000	HA-5000PK			KN-113*	*w/Manual Trans.
420	TRX420FM2 FourTrax Rancher 4x4 w/EPS	15-16	HA-5000	HA-5000PK			KN-113	
420	TRX420FPA Rancher AT 4x4 w/PS	09-13	HA-4207				KN-114	
420	TRX420FPA Rancher AT 4x4 w/PS	14	HA-5000	HA-5000PK			KN-114	
420	TRX420FPE Rancher ES 4x4 w/PS	09-13	HA-4207				KN-113*	*w/Manual Trans.
420	TRX420FPM Rancher 4x4 w/PS	09-13	HA-4207				KN-113*	*w/Manual Trans.
420	TRX420TE FourTrax Rancher ES	07-13	HA-4207				KN-113*	*w/Manual Trans.
420	TRX420TE1 FourTrax Rancher ES	14	HA-5000	HA-5000PK			KN-113*	*w/Manual Trans.
420	TRX420TE1 FourTrax Rancher ES	15-16	HA-5000	HA-5000PK			KN-113	
420	TRX420TM FourTrax Rancher	07-13	HA-4207				KN-113*	*w/Manual Trans.
420	TRX420TM1 FourTrax Rancher	14	HA-5000	HA-5000PK			KN-113*	*w/Manual Trans.
420	TRX420TM1 FourTrax Rancher	15-16	HA-5000	HA-5000PK			KN-113	
420	TRX420TM1 FourTrax Rancher	17	HA-5000	HA-5000PK				
433	TRX450ES Foreman ES	98-01	HA-3098	HA-3098PR			KN-113	
433	TRX450FE Foreman ES	02-03	HA-3098	HA-3098PR			KN-113	
433	TRX450FM Foreman S	03	HA-3098	HA-3098PR			KN-113	
444	TRX450R	04-05	HA-4504	HA-4504PR	63-1127	RX-4990DK	KN-116	
444	TRX450R	04-05	HA-4504	HA-4504PR	63-1127	RX-4990DL	KN-116	
444	TRX450R	04-05	HA-4504	HA-4504PR	63-1127	RX-4990DR	KN-116	
444	TRX450R	04-05	HA-4504	HA-4504PR	63-1127	RX-4990DY	KN-116	
444	TRX450R	04-05	HA-4504	HA-4504PR	HA-4504-T	HA-4504-TDK	KN-116	
450	TRX450ER	06-09	BD-6500	YA-3502DK	HA-4506-T	HA-4504-TDK	KN-116	
450	TRX450ER	12-14	BD-6500	YA-3502DK	HA-4506-T	HA-4504-TDK	KN-116	
450	TRX450FE Foreman ES	04	HA-3098	HA-3098PR			KN-113	
450	TRX450FM Foreman S	02	HA-3098	HA-3098PR			KN-113	
450	TRX450FM Foreman S	04	HA-3098	HA-3098PR			KN-113	
450	TRX450R	06-09	BD-6500	YA-3502DK	HA-4506-T	HA-4504-TDK	KN-116	
450	TRX450R	12	BD-6500	YA-3502DK	HA-4506-T	HA-4504-TDK	KN-116	
450	TRX450S Foreman S	98-01	HA-3098	HA-3098PR			KN-113	
450	TRX450S Foreman S	02					KN-113	
475	SXS500M2 Pioneer	15-16	HA-5015				KN-113	
475	SXS500M2 Pioneer	17	HA-5015					
475	TRX500FA5 FourTrax Foreman Rubicon Auto DCT	15-16	HA-6806	HA-6806DK			KN-114	
475	TRX500FA6 FourTrax Foreman Rubicon Auto DCT EPS	15-16	HA-6806	HA-6806DK			KN-114	
475	TRX500FA6D FourTrax Foreman Rubicon Auto DCT EPS D	15	HA-6806	HA-6806DK			KN-114	
475	TRX500FA6D FourTrax Foreman Rubicon Auto DCT EPS D	16	HA-6806	HA-6806DK				
475	TRX500FA7 FourTrax Foreman Rubicon Auto DCT EPS	16					KN-114	
475	TRX500FE FourTrax Foreman 4x4 ES	05-09	HA-5000	HA-5000PK			KN-113	
475	TRX500FE FourTrax Foreman 4x4 ES	11-13	HA-5000	HA-5000PK			KN-113	
475	TRX500FE1 FourTrax Foreman 4x4 ES	14-16	HA-5000	HA-5000PK			KN-113	
475	TRX500FE2 FourTrax Foreman 4x4 w/EPS	14-16	HA-5000	HA-5000PK			KN-113	
475	TRX500FM FourTrax Foreman 4x4	05-09	HA-5000	HA-5000PK			KN-113	
475	TRX500FM FourTrax Foreman 4x4	11-13	HA-5000	HA-5000PK			KN-113	
475	TRX500FM1 FourTrax Foreman 4x4	14-16	HA-5000	HA-5000PK			KN-113	
475	TRX500FM2 FourTrax Foreman 4x4 w/EPS	14-16	HA-5000	HA-5000PK			KN-113	
475	TRX500FM5 FourTrax Foreman Rubicon	15-16	HA-6806	HA-6806DK			KN-113	

2) Requires Two; 3) Requires Three; 4) Requires Four. The use of custom air filter requires removal of air box. Some custom filters and intakes are not legal for sale or use on any pollution controlled motor vehicle in California or states adopting California emission procedures. See knfilters.com for CARB status on each part for a specific vehicle.

ATV - Application Listing



CC	Model	Year	Air Filter	Air Filter Precharger	Custom	Custom Precharger	Oil Filter	Comments
HONDA								
475	TRX500FM6 FourTrax Foreman Rubicon EPS	15-16	HA-6806	HA-6806DK			KN-113	
475	TRX500FM6D FourTrax Foreman Rubicon EPS DLX	15	HA-6806	HA-6806DK			KN-113	
475	TRX500FM6D FourTrax Foreman Rubicon EPS DLX	16	HA-6806	HA-6806DK				
475	TRX500FM7 FourTrax Foreman Rubicon	16					KN-113	
499	TRX500FA Foreman Rubicon	12-14	HA-6806	HA-6806DK			KN-111	
500	TRX500FA Foreman Rubicon	00					KN-111	
500	TRX500FA Foreman Rubicon	01-09	HA-5000	HA-5000PK			KN-111	
500	TRX500FA Foreman Rubicon	11	HA-5000	HA-5000PK			KN-111	
500	TRX500FGA Foreman Rubicon GPScape	04-08	HA-5000	HA-5000PK			KN-111	
500	TRX500FPA FourTrax Foreman 4x4 AT w/PS	11	HA-5000	HA-5000PK			KN-111	
500	TRX500FPA FourTrax Foreman 4x4 AT w/PS	12	HA-6806	HA-6806DK			KN-111	
500	TRX500FPA FourTrax Foreman Rubicon w/EPS	09	HA-5000	HA-5000PK			KN-111	
500	TRX500FPA FourTrax Foreman Rubicon w/EPS	11	HA-5000	HA-5000PK			KN-111	
500	TRX500FPA FourTrax Foreman Rubicon w/EPS	12-14	HA-6806	HA-6806DK			KN-111	
500	TRX500FPE Foreman 4x4 ES w/PS	07-09	HA-5000	HA-5000PK			KN-113	
500	TRX500FPE Foreman 4x4 ES w/PS	11	HA-5000	HA-5000PK			KN-111	
500	TRX500FPE Foreman 4x4 ES w/PS	11-14	HA-5000	HA-5000PK			KN-113	
500	TRX500FPM Foreman 4x4 w/PS	08-09	HA-5000	HA-5000PK			KN-113	
500	TRX500FPM Foreman 4x4 w/PS	11-14	HA-5000	HA-5000PK			KN-113	
500	TRX500TM Foreman	05-06	HA-5000	HA-5000PK			KN-113	
644	TRX650FA Rincon	03-05	HA-5000	HA-5000PK			KN-111	
650	TRX650FGA Rincon GPScape	04-05	HA-5000	HA-5000PK			KN-111	
675	MUV700 Big Red	09	HA-5000	HA-5000PK				
675	MUV700 Big Red	10-13	HA-5000	HA-5000PK			KN-111	
675	SXS700M2 Pioneer	14-16	HA-5000	HA-5000PK			KN-111	
675	SXS700M2 Pioneer	17	HA-5000	HA-5000PK				
675	SXS700M4 Pioneer 700-4	14-16	HA-5000	HA-5000PK			KN-111	
675	SXS700M4 Pioneer 700-4	17	HA-5000	HA-5000PK				
680	TRX680FA Rincon	06-16	HA-6806	HA-6806DK			KN-111	
680	TRX680FA Rincon	17	HA-6806	HA-6806DK				
680	TRX680FGA Rincon GPScape	06-10	HA-6806	HA-6806DK			KN-111	
700	TRX700XX	08-09	HA-6808				KN-112	
999	SXS10M3 Pioneer	16					KN-114	
999	SXS10M3P Pioneer	16					KN-114	
999	SXS10M5D Pioneer	16					KN-114	
999	SXS10M5P Pioneer	16					KN-114	
HUSQVARNA								
450	QM450	07-08					KN-154	
JOHN DEERE								
500	Buck	05	BD-6502	22-8013PK			KN-557	
500	Buck EX	05	BD-6502	22-8013PK			KN-557	
500	Buck EXT	05	BD-6502	22-8013PK			KN-557	
500	Trail Buck 500	05	BD-6502	22-8013PK			KN-557	
650	Trail Buck 650	05	BD-6502	22-8013PK			KN-556	
650	Trail Buck 650 EX	05	BD-6502	22-8013PK			KN-556	
650	Trail Buck 650 EXT	05	BD-6502	22-8013PK			KN-556	
KAWASAKI								
80	KFX80	03-06	SU-8087					
200	KLT200	80-84					KN-123	
215	KLF220 Bayou	88-01	KA-2288	KA-2288PL			KN-123	

2) Requires Two; 3) Requires Three; 4) Requires Four. The use of custom air filter requires removal of air box. Some custom filters and intakes are not legal for sale or use on any pollution controlled motor vehicle in California or states adopting California emission procedures. See knfilters.com for CARB status on each part for a specific vehicle.



ATV - Application Listing

CC	Model	Year	Air Filter	Air Filter Precharger	Custom	Custom Precharger	Oil Filter	Comments
KAWASAKI								
220	KLF220 Bayou	02	KA-2288	KA-2288PL			KN-123	
228	KLF250 Bayou	04-09	KA-2288	KA-2288PL			KN-123	
249	KLF250 Bayou	03	KA-2288	KA-2288PL			KN-123	
249	KSF250 Mojave	87-03	KA-2587	25-2587			KN-123	
250	KLF250 Bayou	10-11	KA-2288	KA-2288PL			KN-123	
250	KLT250	82-85					KN-123	
250	KSF250 Mojave	04	KA-2587	25-2587			KN-123	
250	KXF250 Tecate 4	87-88	KA-1780					
250	KXT250 Tecate	86-87	KA-1780					
271	KVF300 Brute Force	12-15	KA-2712					
271	KVF300 Brute Force	16	KA-2712				KN-204*	*Chrome=KN-204C
271	KVF300 Brute Force	17	KA-2712					
290	KEF300 Lakota	95-00	KA-2587	25-2587			KN-123	
290	KEF300 Lakota	01					KN-123	
290	KEF300 Lakota Sport	01-02	KA-2587	25-2587			KN-123	
290	KLF300 Bayou 2x4	86-87					KN-123	
290	KLF300 Bayou 2x4	88-91	KA-2288	KA-2288PL			KN-123	
290	KLF300 Bayou 2x4	92-03	KA-4093	KA-4093PL			KN-123	
290	KVF300 Prairie 2x4	99-02	KA-4093	KA-4093PL			KN-303*	*Chrome=KN-303C
300	KAF300 Mule 500	91	KA-4093	KA-4093PL			KN-128	
300	KAF300 Mule 500	93	KA-4093	KA-4093PL			KN-128	
300	KAF300 Mule 500	95	KA-4093	KA-4093PL			KN-128	
300	KAF300 Mule 520	00-01	KA-4093	KA-4093PL			KN-128	
300	KAF300 Mule 550	97-01	KA-4093	KA-4093PL			KN-128	
300	KAF300 Mule 550	03-04	KA-4093	KA-4093PL			KN-128	
300	KEF300 Lakota	02-03					KN-123	
300	KLF300 Bayou 2x4	04	KA-4093	KA-4093PL			KN-123	
300	KLF300 Bayou 4x4	89-04	KA-4093	KA-4093PL			KN-123	
300	KVF300 Prairie 4x4	99-02	KA-4093	KA-4093PL			KN-303*	*Chrome=KN-303C
360	KVF360 Prairie 2x4	04-09	KA-3603	KA-3603PK			KN-204*	*Chrome=KN-204C
360	KVF360 Prairie 4x4	03-13	KA-3603	KA-3603PK			KN-204*	*Chrome=KN-204C
360	KVF360 Prairie 4x4	14					KN-204*	*Chrome=KN-204C
360	KVF360 Prairie 4x4 Hardwoods Green HD	04-11	KA-3603	KA-3603PK			KN-204*	*Chrome=KN-204C
392	KLF400 Bayou 4x4	93-99	KA-4093	KA-4093PL			KN-303*	*Chrome=KN-303C
392	KVF360 Prairie 2x4	03	KA-3603	KA-3603PK			KN-204*	*Chrome=KN-204C
392	KVF400 Prairie 2x4	98-01	KA-4093	KA-4093PL			KN-303*	*Chrome=KN-303C
392	KVF400 Prairie 4x4	97	KA-4093	KA-4093PL			KN-303*	*Chrome=KN-303C
400	KAF400 Mule 600	05-16	KA-4093	KA-4093PL			KN-128	
400	KAF400 Mule 610 4x4	05-16	KA-4093	KA-4093PL			KN-128	
400	KAF400 Mule 610 4x4 Hardwoods Green HD	05-09	KA-4093	KA-4093PL			KN-128	
400	KAF400 Mule 610 4x4 SE	16	KA-4093	KA-4093PL			KN-128	
400	KAF400 Mule 610 4x4 XC	10-16	KA-4093	KA-4093PL			KN-128	
400	KAF400 Mule 610 4x4 XC SE	14-16	KA-4093	KA-4093PL			KN-128	
400	KFX400	03-06	SU-4002	SU-4002PK	SU-4002-T	SU-4002-TDK	KN-139	
400	KVF400 Prairie 2x4	02	KA-4093	KA-4093PL			KN-303*	*Chrome=KN-303C
400	KVF400 Prairie 4x4	98-02	KA-4093	KA-4093PL			KN-303*	*Chrome=KN-303C
449	KFX450R	08-09	KA-4508	KA-4508DK	63-1124	RC-4630DK	KN-112	
449	KFX450R	08-09	KA-4508	KA-4508DK	63-1124	RC-4630DL	KN-112	
449	KFX450R	08-09	KA-4508	KA-4508DK	63-1124	RC-4630DR	KN-112	
449	KFX450R	08-09	KA-4508	KA-4508DK	63-1124	RC-4630DY	KN-112	
449	KFX450R	10-14	KA-4508	KA-4508DK			KN-112	
450	KAF450 Mule 1000	88					KN-303*	*Chrome=KN-303C
540	KAF540 Mule 2010	90					KN-303*	*Chrome=KN-303C
540	KAF540 Mule 2020	90					KN-303*	*Chrome=KN-303C
540	KAF540 Mule 2030	91					KN-303*	*Chrome=KN-303C

2) Requires Two; 3) Requires Three; 4) Requires Four. The use of custom air filter requires removal of air box. Some custom filters and intakes are not legal for sale or use on any pollution controlled motor vehicle in California or states adopting California emission procedures. See knfilters.com for CARB status on each part for a specific vehicle.

ATV - Application Listing



CC	Model	Year	Air Filter	Air Filter Precharger	Custom	Custom Precharger	Oil Filter	Comments
KAWASAKI								
617	KAF620 Mule 4000	09-10	KA-6201				KN-128	
617	KAF620 Mule 4000	11					KN-128	
617	KAF620 Mule 4000	12-16	KA-6201				KN-128	
617	KAF620 Mule 4010 4x4	09-16	KA-6201				KN-128	
617	KAF620 Mule 4010 4x4 SE	16	KA-6201				KN-128	
617	KAF620 Mule 4010 Trans 4x4	09-16	KA-6201				KN-128	
617	KAF620 Mule 4010 Trans 4x4 Camo	15-16					KN-128	
617	KAF620 Mule 4010 Trans 4x4 SE	16	KA-6201				KN-128	
620	KAF620 Mule 2500	94-95	KA-4093	KA-4093PL			KN-128	
620	KAF620 Mule 2500	97-00	KA-4093	KA-4093PL			KN-128	
620	KAF620 Mule 2510 4x4	93	KA-4093	KA-4093PL			KN-128	
620	KAF620 Mule 2510 4x4	95	KA-4093	KA-4093PL			KN-128	
620	KAF620 Mule 2510 4x4	97-00	KA-4093	KA-4093PL			KN-128	
620	KAF620 Mule 2520	93	KA-4093	KA-4093PL			KN-128	
620	KAF620 Mule 2520	95	KA-4093	KA-4093PL			KN-128	
620	KAF620 Mule 2520	97-00	KA-4093	KA-4093PL			KN-128	
620	KAF620 Mule 3000	01-08	KA-6201				KN-128	
620	KAF620 Mule 3010 4x4	01-08	KA-6201				KN-128	
620	KAF620 Mule 3010 4x4 Hardwoods Green HD	04-08	KA-6201				KN-128	
620	KAF620 Mule 3010 Trans4x4	05-08	KA-6201				KN-128	
620	KAF620 Mule 3010 Trans4x4 Hardwoods Green HD	05-08	KA-6201				KN-128	
620	KAF620 Mule 3020	01-03	KA-6201				KN-128	
635	KVF650 Prairie 4x4	02	KA-6502				KN-204*	*Chrome=KN-204C
635	KVF650 Prairie 4x4	03	KA-6503	KA-6503PK			KN-204*	*Chrome=KN-204C
650	KVF650 Brute Force 4x4	05-13	KA-6503	KA-6503PK			KN-204*	*Chrome=KN-204C
650	KVF650 Brute Force 4x4	14					KN-204*	*Chrome=KN-204C
650	KVF650 Brute Force 4x4i	06-09	KA-7504	KA-7504PK			KN-204*	*Chrome=KN-204C
650	KVF650 Brute Force 4x4i	11-13	KA-7504	KA-7504PK			KN-204*	*Chrome=KN-204C
650	KVF650 Brute Force 4x4i	14					KN-204*	*Chrome=KN-204C
697	KFX700	05-06	KA-6503	KA-6503PK			KN-204*	*Chrome=KN-204C
697	KFX700 V Force	04	KA-6503	KA-6503PK			KN-204*	*Chrome=KN-204C
700	KFX700	07-09	KA-6503	KA-6503PK			KN-204*	*Chrome=KN-204C
700	KFX700	10-11	KA-6503	KA-6503PK			KN-204*	*Chrome=KN-204C
700	KVF700 Prairie 4x4	04-06	KA-6503	KA-6503PK			KN-204*	*Chrome=KN-204C
700	KVF700 Prairie 4x4 Hardwoods Green HD	04-05	KA-6503	KA-6503PK			KN-204*	*Chrome=KN-204C
700	KVF700 Prairie 4x4 Team Green	05-06	KA-6503	KA-6503PK			KN-204*	*Chrome=KN-204C
749	KRF750 Teryx FI 4x4	13	KA-7513				KN-204*	*Chrome=KN-204C
749	KRF750 Teryx FI 4x4 LE	13	KA-7513				KN-204*	*Chrome=KN-204C
749	KRF750 Teryx FI 4x4 Sport	13	KA-7513				KN-204*	*Chrome=KN-204C
749	KRF750 Teryx4 4x4 EPS	13	KA-7512				KN-204*	*Chrome=KN-204C
749	KRF750 Teryx4 4x4 EPS LE	13	KA-7512				KN-204*	*Chrome=KN-204C
749	KRT750 Teryx4	12	KA-7512				KN-204*	*Chrome=KN-204C
749	KRT750 Teryx4	13					KN-204*	*Chrome=KN-204C
749	KVF750 Brute Force 4x4i	08-16	KA-7408	KA-7408DK			KN-204*	*Chrome=KN-204C
749	KVF750 Brute Force 4x4i EPS	14-16	KA-7408	KA-7408DK			KN-204*	*Chrome=KN-204C
749	KVF750 Brute Force 4x4i EPS Camo	16					KN-204*	*Chrome=KN-204C
750	KRF750 Teryx 4x4	08	KA-7508	KA-7508DK			KN-204*	*Chrome=KN-204C
750	KRF750 Teryx 4x4 LE	08	KA-7508	KA-7508DK			KN-204*	*Chrome=KN-204C
750	KRF750 Teryx 4x4 LE	09					KN-204*	*Chrome=KN-204C
750	KRF750 Teryx 4x4 NRA Outdoors	08	KA-7508	KA-7508DK			KN-204*	*Chrome=KN-204C
750	KRF750 Teryx FI 4x4	09-12	KA-7508	KA-7508DK			KN-204*	*Chrome=KN-204C
750	KRF750 Teryx FI 4x4	14					KN-204*	*Chrome=KN-204C
750	KRF750 Teryx FI 4x4 LE	09-12	KA-7508	KA-7508DK			KN-204*	*Chrome=KN-204C
750	KRF750 Teryx FI 4x4 LE	14					KN-204*	*Chrome=KN-204C

2) Requires Two; 3) Requires Three; 4) Requires Four. The use of custom air filter requires removal of air box. Some custom filters and intakes are not legal for sale or use on any pollution controlled motor vehicle in California or states adopting California emission procedures. See knfilters.com for CARB status on each part for a specific vehicle.



ATV - Application Listing

CC	Model	Year	Air Filter	Air Filter Precharger	Custom	Custom Precharger	Oil Filter	Comments
KAWASAKI								
750	KRF750 Teryx FI 4x4 LE Camo	09	KA-7508	KA-7508DK			KN-204*	*Chrome=KN-204C
750	KRF750 Teryx FI 4x4 LE Camo	13	KA-7513				KN-204*	*Chrome=KN-204C
750	KRF750 Teryx FI 4x4 LE Camo	14					KN-204*	*Chrome=KN-204C
750	KRF750 Teryx FI 4x4 NRA Outdoors	09	KA-7508	KA-7508DK			KN-204*	*Chrome=KN-204C
750	KRF750 Teryx FI 4x4 Sport	09-12	KA-7508	KA-7508DK			KN-204*	*Chrome=KN-204C
750	KRF750 Teryx FI 4x4 Sport	14					KN-204*	*Chrome=KN-204C
750	KVF750 Brute Force 4x4i	05-07	KA-7504	KA-7504PK			KN-204*	*Chrome=KN-204C
783	KRF800 Teryx	14	KA-7512				KN-204*	*Chrome=KN-204C
783	KRF800 Teryx	15	KA-7512					
783	KRF800 Teryx	16	KA-7512				KN-204*	*Chrome=KN-204C
783	KRF800 Teryx Camo	14	KA-7512				KN-204*	*Chrome=KN-204C
783	KRF800 Teryx Camo	15	KA-7512					
783	KRF800 Teryx Camo	16	KA-7512				KN-204*	*Chrome=KN-204C
783	KRF800 Teryx LE	14	KA-7512				KN-204*	*Chrome=KN-204C
783	KRF800 Teryx LE	15	KA-7512					
783	KRF800 Teryx LE	16	KA-7512				KN-204*	*Chrome=KN-204C
783	KRT800 Teryx4	14	KA-7512				KN-204*	*Chrome=KN-204C
783	KRT800 Teryx4	15	KA-7512					
783	KRT800 Teryx4	16	KA-7512				KN-204*	*Chrome=KN-204C
783	KRT800 Teryx4 Camo	14	KA-7512				KN-204*	*Chrome=KN-204C
783	KRT800 Teryx4 Camo	15	KA-7512					
783	KRT800 Teryx4 Camo	16	KA-7512				KN-204*	*Chrome=KN-204C
783	KRT800 Teryx4 LE	14	KA-7512				KN-204*	*Chrome=KN-204C
783	KRT800 Teryx4 LE	15	KA-7512					
783	KRT800 Teryx4 LE	16	KA-7512				KN-204*	*Chrome=KN-204C
812	KAF800 Mule PRO-FX	16					KN-128	
812	KAF800 Mule PRO-FX EPS	16					KN-128	
812	KAF800 Mule PRO-FX EPS Camo	16					KN-128	
812	KAF800 Mule PRO-FX EPS LE	16					KN-128	
812	KAF800 Mule PRO-FXT	16					KN-128	
812	KAF800 Mule PRO-FXT EPS	16					KN-128	
812	KAF800 Mule PRO-FXT Ranch Edit.	16					KN-128	
950	KAF950 Mule 2510 Diesel	00-02	KA-6201					
950	KAF950 Mule 3010 Diesel 4x4	03-08	KA-6201					
950	KAF950 Mule 3010 Trans4x4 Diesel	07-08	KA-6201					
950	KAF950 Mule 4010 Trans4x4 Diesel	09-12	KA-6201					
953	KAF950 Mule 4010 Diesel 4x4	09-13	KA-6201					
KTM								
449	450 SX	10					KN-652	
449	450 XC	08	KT-4511XD	KT-4511DK			KN-155*	*Tall Filter
449	450 XC	08	KT-4511XD	KT-4511DK			KN-157*	*Short Filter
450	450 XC	09-10					KN-155*	*Tall Filter
450	450 XC	09-10					KN-157*	*Short Filter
510	525 XC	07	KT-5201	KT-5201DK				
525	525 XC	08-09					KN-155*	*Tall Filter
525	525 XC	08-09					KN-157*	*Short Filter
525	525 XC ATV	10					KN-155*	*Tall Filter
525	525 XC ATV	10					KN-157*	*Short Filter
KYMCO								
250	KXR250	04	KY-2504	SU-2504PK				
250	Mongoose 250	04-09	KY-2504	SU-2504PK				
250	MXU250	05-09	KY-2504	SU-2504PK				
300	Mongoose 300	06-09	KY-2504	SU-2504PK				
300	MXU300	06-09	KY-2504	SU-2504PK				
375	MXU375	09-13					KN-138*	*Chrome=KN-138C

2) Requires Two; 3) Requires Three; 4) Requires Four. The use of custom air filter requires removal of air box. Some custom filters and intakes are not legal for sale or use on any pollution controlled motor vehicle in California or states adopting California emission procedures. See knfilters.com for CARB status on each part for a specific vehicle.

ATV - Application Listing



CC	Model	Year	Air Filter	Air Filter Precharger	Custom	Custom Precharger	Oil Filter	Comments
KYMCO								
400	MXU400	08-12					KN-138*	*Chrome=KN-138C
443	Maxxer 450i	15					KN-138*	*Chrome=KN-138C
443	Maxxer 450i 4x4	14-15					KN-138*	*Chrome=KN-138C
443	UXV 450i	15-16					KN-138*	*Chrome=KN-138C
443	UXV 450i Camo	15-16					KN-138*	*Chrome=KN-138C
443	UXV 450i LE	16					KN-138*	*Chrome=KN-138C
443	UXV 450i LE 50th Anniversary	15					KN-138*	*Chrome=KN-138C
443	UXV 450i Turf	15-16					KN-138*	*Chrome=KN-138C
450	MXU450i	11					KN-138*	*Chrome=KN-138C
450	MXU450i	15					KN-138*	*Chrome=KN-138C
450	MXU450i 4x4 IRS	12-14					KN-138*	*Chrome=KN-138C
450	MXU450i 4x4 IRS LE	12-14					KN-138*	*Chrome=KN-138C
450	MXU450i Camo	15					KN-138*	*Chrome=KN-138C
450	MXU450i LE 50th Anniversary	15					KN-138*	*Chrome=KN-138C
500	MXU500	06-09					KN-147	
500	MXU500	12-15					KN-147	
500	MXU500 IRS	10-11					KN-147	
500	MXU500i	15					KN-147	
500	MXU500i Camo	15					KN-147	
500	MXU500i Camo EPS	15					KN-147	
500	MXU500i LE 50th Anniversary EPS	15					KN-147	
500	UXV 500	15					KN-147	
500	UXV 500 4x4	09-14					KN-147	
500	UXV 500 4X4 LE	10-11					KN-147	
500	UXV 500 4X4 SE	11					KN-147	
500	UXV 500i	15-16					KN-147	
500	UXV 500i 4X4	12-14					KN-147	
500	UXV 500i Camo	15-16					KN-147	
500	UXV 500i G	15					KN-147	
500	UXV 500i HE	14					KN-147	
500	UXV 500i LE	12-14					KN-147	
500	UXV 500i LE 50th Anniversary	15					KN-147	
500	UXV 500i SE	12-13					KN-147	
500	UXV 500i SP	13-14					KN-147	
500	UXV 500i Turf	14-16					KN-147	
550	MXU550	11-12					KN-147	
695	UXV 700i	14-16					KN-147	
695	UXV 700i Camo	15-16					KN-147	
695	UXV 700i HE	14					KN-147	
695	UXV 700i LE	14					KN-147	
695	UXV 700i LE	16					KN-147	
695	UXV 700i LE 50th Anniversary	15					KN-147	
695	UXV 700i SP	14					KN-147	
695	UXV 700i Turf	14-16					KN-147	
700	MXU700i	14-16					KN-147	
700	MXU700i Camo	15					KN-147	
700	MXU700i Camo EPS	15					KN-147	
700	MXU700i LE 50th Anniversary EPS	15					KN-147	
POLARIS								
169	Ranger RZR 170	10-13	PL-1710	PL-1004PK				
169	RZR 170	14	PL-1710	PL-1004PK				
169	RZR 170 EFI	15-16	PL-1710	PL-1004PK				
196	Phoenix 200	10-17	PL-1004	PL-1004PK				
200	Phoenix 200	05-09	PL-1004	PL-1004PK				
200	Sawtooth	06-07	PL-1004	PL-1004PK				

2) Requires Two; 3) Requires Three; 4) Requires Four. The use of custom air filter requires removal of air box. Some custom filters and intakes are not legal for sale or use on any pollution controlled motor vehicle in California or states adopting California emission procedures. See knfilters.com for CARB status on each part for a specific vehicle.



ATV - Application Listing

CC	Model	Year	Air Filter	Air Filter Precharger	Custom	Custom Precharger	Oil Filter	Comments
POLARIS								
244	Trail Blazer 250	91-00	PL-1001					
244	Trail Blazer 250	01-02	PL-1004	PL-1004PK				
244	Trail Blazer 250	04-06	PL-1004	PL-1004PK				
244	Trail Boss 250	90-99	PL-1001					
244	Xplorer 250 4x4	00	PL-1001					
244	Xplorer 250 4x4	01-02	PL-1004	PL-1004PK				
250	Trail Blazer 250	90	PL-1001					
281	Trail Blazer 250	03	PL-1004	PL-1004PK				
281	Xplorer 300 4x4	96-99	PL-1001					
300	Hawkeye 2x4	06-07	PL-1004	PL-1004PK			KN-303*	*Chrome=KN-303C
300	Hawkeye 2x4	08					KN-303*	*Chrome=KN-303C
300	Hawkeye 2x4	09-10	PL-1004	PL-1004PK			KN-303*	*Chrome=KN-303C
300	Hawkeye 300	11					KN-303*	*Chrome=KN-303C
300	Hawkeye 4x4	07	PL-1004	PL-1004PK			KN-303*	*Chrome=KN-303C
300	Xpress 300	96-99	PL-1001					
325	Ace	16					KN-116	
325	Magnum 325 2x4	00	PL-1003	PL-1003PK			KN-303*	*Chrome=KN-303C
325	Magnum 325 2x4	01	PL-1003*	PL-1003PK			KN-303**	*Built Before 1/8/01/ **Chrome=KN-303C
325	Magnum 325 2x4	01	PL-1005*	HA-3094PR			KN-303**	*Built After 1/8/01/ **Chrome=KN-303C
325	Magnum 325 2x4	02	PL-1005	HA-3094PR			KN-303*	*Chrome=KN-303C
325	Magnum 325 4x4	00	PL-1003	PL-1003PK			KN-303*	*Chrome=KN-303C
325	Magnum 325 4x4	01	PL-1003*	PL-1003PK			KN-303**	*Built Before 1/8/01/ **Chrome=KN-303C
325	Magnum 325 4x4	01	PL-1005*	HA-3094PR			KN-303**	*Built After 1/8/01/ **Chrome=KN-303C
325	Magnum 325 4x4	02	PL-1005	HA-3094PR			KN-303*	*Chrome=KN-303C
325	Magnum 330 4x4	03-06	PL-1005	HA-3094PR			KN-303*	*Chrome=KN-303C
325	Sportsman Ace	14	PL-3214	PL-3214DK				
325	Sportsman Ace	15	PL-3214	PL-3214DK			KN-116	
325	Sportsman Ace	16	PL-3214	PL-3214DK				
325	Sportsman ETX	15					KN-116	
325	Trail Boss 325 2x4	00	PL-1003	PL-1003PK			KN-303*	*Chrome=KN-303C
325	Trail Boss 325 2x4	01	PL-1003*	PL-1003PK			KN-303**	*Built Before 12/11/00/ **Chrome=KN-303C
325	Trail Boss 325 2x4	01	PL-1005*	HA-3094PR			KN-303**	*Built After 12/11/00/ **Chrome=KN-303C
325	Trail Boss 325 2x4	02	PL-1005	HA-3094PR			KN-303*	*Chrome=KN-303C
325	Trail Boss 330	04-09	PL-1005	HA-3094PR			KN-303*	*Chrome=KN-303C
325	Xpedition 325	00-02	PL-1003	PL-1003PK			KN-303*	*Chrome=KN-303C
329	Hawkeye 4x4	06	PL-1004	PL-1004PK			KN-303*	*Chrome=KN-303C
329	Sportsman 300	08-10	PL-1004	PL-1004PK			KN-303*	*Chrome=KN-303C
329	Sportsman 300 LE	08-09	PL-1004	PL-1004PK			KN-303*	*Chrome=KN-303C
329	Trail Blazer 330	10-13	PL-1003	PL-1003PK			KN-303*	*Chrome=KN-303C
329	Trail Boss 330	10-13	PL-1003	PL-1003PK			KN-303*	*Chrome=KN-303C
330	Magnum 330 2x4	03-05	PL-1005	HA-3094PR			KN-303*	*Chrome=KN-303C
330	Magnum 330 4x4 Mossy Oak	04	PL-1005	HA-3094PR			KN-303*	*Chrome=KN-303C
330	Trail Blazer 330	08-09	PL-1005	HA-3094PR			KN-303*	*Chrome=KN-303C
332	ATP330	04-05	PL-1005	HA-3094PR			KN-303*	*Chrome=KN-303C
334	Sportsman 335	99-01	PL-1003	PL-1003PK			KN-303*	*Chrome=KN-303C
334	Trail Boss 330	03	PL-1005	HA-3094PR			KN-303*	*Chrome=KN-303C
335	Worker 335	99	PL-1003	PL-1003PK			KN-303*	*Chrome=KN-303C
350	Trail Boss 350L 2x4	92	PL-1001					
377	Scrambler 400 4x4	96-02	PL-1002	PL-1002PK				
377	Sportsman 400 4x4	94-96	PL-1001					
377	Xplorer 400L	96-98	PL-1001				KN-303*	*Chrome=KN-303C

2) Requires Two; 3) Requires Three; 4) Requires Four. The use of custom air filter requires removal of air box. Some custom filters and intakes are not legal for sale or use on any pollution controlled motor vehicle in California or states adopting California emission procedures. See knfilters.com for CARB status on each part for a specific vehicle.

ATV - Application Listing



CC	Model	Year	Air Filter	Air Filter Precharger	Custom	Custom Precharger	Oil Filter	Comments
POLARIS								
377	Xplorer 400L	99-00	PL-1002	PL-1002PK			KN-303*	*Chrome=KN-303C
377	Xplorer 400L	01	PL-1004	PL-1004PK			KN-303*	*Chrome=KN-303C
400	Big Boss 6x6 400L	95-97	PL-1001					
400	Hawkeye 400 HO 2x4	11	PL-1003	PL-1003PK			KN-303*	*Chrome=KN-303C
400	Scrambler 400 2x4	00-02	PL-1002	PL-1002PK				
400	Sport 400L	94-95	PL-1001					
400	Sport 400L	96-97	PL-1002	PL-1002PK				
400	Sport 400L	99	PL-1002	PL-1002PK				
400	Sportsman 400 2x4	01	PL-1003	PL-1003PK			KN-303*	*Chrome=KN-303C
400	Trail Blazer 400 2x4	03	PL-1002	PL-1002PK				
400	Xplorer 400L	02	PL-1004	PL-1004PK				
400	Xpress 400L	96-97	PL-1002	PL-1002PK				
425	Magnum 425 2x4	96-98	PL-1002	PL-1002PK			KN-303*	*Chrome=KN-303C
425	Magnum 425 6x6	96-97	PL-1002	PL-1002PK			KN-303*	*Chrome=KN-303C
425	Ranger 2x4 425	01	PL-1003	PL-1003PK			KN-303*	*Chrome=KN-303C
425	Ranger 2x4 425	02					KN-303*	*Chrome=KN-303C
425	Ranger 2x4 425	03	PL-5008	PL-5008DK			KN-303*	*Chrome=KN-303C
425	Ranger 2x4 425	04					KN-303*	*Chrome=KN-303C
425	Xpedition	00-02	PL-1003	PL-1003PK			KN-303*	*Chrome=KN-303C
427	Magnum 425 2x4	95					KN-303*	*Chrome=KN-303C
427	Magnum 425 4x4	95-98	PL-1002	PL-1002PK			KN-303*	*Chrome=KN-303C
427	Sportsman 400 4x4	01-05	PL-1003	PL-1003PK			KN-303*	*Chrome=KN-303C
450	Outlaw 450 MXR	08-09					KN-155*	*Tall Filter
450	Outlaw 450 MXR	08-09					KN-157*	*Short Filter
455	Diesel 455	99-01	PL-1003	PL-1003PK			KN-303*	*Chrome=KN-303C
455	Diesel 455	02					KN-303*	*Chrome=KN-303C
455	Ranger 4x4 400	10-14	PL-5008	PL-5008DK			KN-303*	*Chrome=KN-303C
455	Sportsman 400 H.O.	08-14	PL-1003	PL-1003PK			KN-303*	*Chrome=KN-303C
455	Sportsman 400 HO South Edition	13-14	PL-1003	PL-1003PK			KN-303*	*Chrome=KN-303C
455	Sportsman 450	06-07	PL-1003	PL-1003PK			KN-303*	*Chrome=KN-303C
496	ATP500 HO	04-05	PL-1003	PL-1003PK			KN-303*	*Chrome=KN-303C
496	Magnum 500 2x4	02					KN-303*	*Chrome=KN-303C
496	Magnum 500 4x4	99-02	PL-1003	PL-1003PK			KN-303*	*Chrome=KN-303C
496	Predator 500	03-07	PL-5003				KN-112	
496	Predator 500 TLD	06	PL-5003				KN-112	
496	Scrambler 500	96					KN-303*	*Chrome=KN-303C
496	Sportsman 500	01	PL-1003	PL-1003PK			KN-303*	*Chrome=KN-303C
496	Sportsman 500 6x6	01-08	PL-1003	PL-1003PK			KN-303*	*Chrome=KN-303C
496	Sportsman 500 6x6	09	PL-1003	PL-1003PK			KN-303*	*Chrome=KN-303C
496	Sportsman 500 EFI	06	PL-1003	PL-1003PK			KN-303*	*Chrome=KN-303C
496	Sportsman 500 EFI	08-09	PL-1003	PL-1003PK			KN-303*	*Chrome=KN-303C
496	Sportsman 500 Efi LE	08-09	PL-1003	PL-1003PK			KN-303*	*Chrome=KN-303C
496	Sportsman 500 EFI Touring	08-09	PL-1003	PL-1003PK			KN-303*	*Chrome=KN-303C
496	Sportsman 500 Efi Touring Le	08-09	PL-1003	PL-1003PK			KN-303*	*Chrome=KN-303C
496	Sportsman 500 Efi X2	06	PL-1003	PL-1003PK			KN-303*	*Chrome=KN-303C
498	Ranger 500 Crew	11	PL-5008	PL-5008DK			KN-198	
498	Ranger 500 Crew	12-13	PL-5008	PL-5008DK			KN-303*	*Chrome=KN-303C
498	Ranger 500 Crew LE	13	PL-5008	PL-5008DK			KN-303*	*Chrome=KN-303C
498	Ranger 500 Crew Turbo Silver LE	12	PL-5008	PL-5008DK			KN-303*	*Chrome=KN-303C
498	Sportsman 500 EFI	12	PL-1003	PL-1003PK			KN-303*	*Chrome=KN-303C
498	Sportsman 500 HO	10-13	PL-1003	PL-1003PK			KN-303*	*Chrome=KN-303C
498	Sportsman 500 HO Polaris Pursuite LE	12	PL-1003	PL-1003PK			KN-303*	*Chrome=KN-303C
498	Sportsman 500 HO Touring	13	PL-1003	PL-1003PK			KN-303*	*Chrome=KN-303C
498	Sportsman Forest 500	12	PL-1003	PL-1003PK				
498	Sportsman Forest 550	12	PL-1003	PL-1003PK				

2) Requires Two; 3) Requires Three; 4) Requires Four. The use of custom air filter requires removal of air box. Some custom filters and intakes are not legal for sale or use on any pollution controlled motor vehicle in California or states adopting California emission procedures. See knfilters.com for CARB status on each part for a specific vehicle.



ATV - Application Listing

CC	Model	Year	Air Filter	Air Filter Precharger	Custom	Custom Precharger	Oil Filter	Comments
POLARIS								
498	Sportsman Forest 800	12	PL-1003	PL-1003PK				
498	Sportsman Forest 800 6x6	12	PL-1003	PL-1003PK				
498	Sportsman Forest 850	12	PL-5509	PL-1003PK				
498	Sportsman Forest Tractor 500	12	PL-1003	PL-1003PK				
499	Ranger 4x4 500 EFI	06-09	PL-5008	PL-5008DK			KN-303*	*Chrome=KN-303C
499	Ranger 4x4 EFI	10-13	PL-5008	PL-5008DK			KN-303*	*Chrome=KN-303C
499	Sportsman 500 EFI	07	PL-1003	PL-1003PK			KN-303*	*Chrome=KN-303C
499	Sportsman 500 EFI Deluxe	07	PL-1003	PL-1003PK			KN-303*	*Chrome=KN-303C
499	Sportsman 500 Efi X2	07	PL-1003	PL-1003PK			KN-303*	*Chrome=KN-303C
499	Sportsman 500 Efi X2 Deluxe	07	PL-1003	PL-1003PK			KN-303*	*Chrome=KN-303C
500	Big Boss 500 6x6	98-99	PL-1002	PL-1002PK			KN-303*	*Chrome=KN-303C
500	Magnum 500 4x4	03	PL-1003	PL-1003PK			KN-303*	*Chrome=KN-303C
500	Outlaw 500	06-07	PL-5006	PL-5006DK			KN-112	
500	Predator 500 TLD	05	PL-5003				KN-112	
500	Ranger 2x4 500	04-08	PL-5008	PL-5008DK			KN-303*	*Chrome=KN-303C
500	Ranger 2x4 500	09					KN-303*	*Chrome=KN-303C
500	Ranger 4x4 500	03-06	PL-5008	PL-5008DK			KN-303*	*Chrome=KN-303C
500	Ranger 4x4 500	07					KN-303*	*Chrome=KN-303C
500	Ranger 6x6 500	99					KN-303*	*Chrome=KN-303C
500	Ranger 6x6 500	00	PL-5008	PL-5008DK			KN-303*	*Chrome=KN-303C
500	Ranger 6x6 500	01-03					KN-303*	*Chrome=KN-303C
500	Ranger 6x6 500	04-05	PL-5008	PL-5008DK			KN-303*	*Chrome=KN-303C
500	Scrambler 500 2x4	01-02	PL-1003	PL-1003PK			KN-303*	*Chrome=KN-303C
500	Scrambler 500 4x4	97-12	PL-1003	PL-1003PK			KN-303*	*Chrome=KN-303C
500	Sportsman 450 HO	16	PL-1003	PL-1003PK				
500	Sportsman 500	02	PL-1003	PL-1003PK			KN-303*	*Chrome=KN-303C
500	Sportsman 500 4x4	96-00	PL-1003	PL-1003PK			KN-303*	*Chrome=KN-303C
500	Sportsman 500 6x6	00	PL-1003	PL-1003PK			KN-303*	*Chrome=KN-303C
500	Sportsman 500 6x6 MV	07	PL-1003	PL-1003PK			KN-303*	*Chrome=KN-303C
500	Sportsman 500 EFI	10	PL-1003	PL-1003PK			KN-303*	*Chrome=KN-303C
500	Sportsman 500 EFI Touring	10	PL-1003	PL-1003PK			KN-303*	*Chrome=KN-303C
500	Sportsman 500 Efi X2	08-09	PL-1003	PL-1003PK			KN-303*	*Chrome=KN-303C
500	Sportsman 500 HO	00					KN-303*	*Chrome=KN-303C
500	Sportsman 500 HO	01	PL-1003	PL-1003PK			KN-303*	*Chrome=KN-303C
500	Sportsman 500 HO	04-06	PL-1003	PL-1003PK			KN-303*	*Chrome=KN-303C
500	Sportsman 500 HO	07					KN-303*	*Chrome=KN-303C
500	Sportsman 500 HO	08-09	PL-1003	PL-1003PK			KN-303*	*Chrome=KN-303C
500	Sportsman 500 HO 4x4	02-03	PL-1003	PL-1003PK			KN-303*	*Chrome=KN-303C
500	Sportsman 500 HO DUSE	01	PL-1003	PL-1003PK			KN-303*	*Chrome=KN-303C
500	Sportsman 500 HO Mossy Oak	04	PL-1003	PL-1003PK			KN-303*	*Chrome=KN-303C
500	Sportsman 500 HO RSE	01	PL-1003	PL-1003PK			KN-303*	*Chrome=KN-303C
500	Sportsman 500 HO Touring	10-12	PL-1003	PL-1003PK			KN-303*	*Chrome=KN-303C
500	Sportsman X2	06	PL-1003	PL-1003PK			KN-303*	*Chrome=KN-303C
500	Worker 500	99	PL-1003	PL-1003PK			KN-303*	*Chrome=KN-303C
500	Worker 500	00-01					KN-303*	*Chrome=KN-303C
500	Xplorer 500 4x4	97	PL-1003	PL-1003PK			KN-303*	*Chrome=KN-303C
510	Outlaw 525 S	08-10					KN-155*	*Tall Filter
510	Outlaw 525 S	08-10					KN-157*	*Short Filter
525	Outlaw 525	08-09					KN-155*	*Tall Filter
525	Outlaw 525	08-09					KN-157*	*Short Filter
525	Outlaw 525 IRS	07-11	PL-5207	PL-5207DK			KN-155*	*Tall Filter
525	Outlaw 525 IRS	07-11	PL-5207	PL-5207DK			KN-157*	*Short Filter
549	Sportsman 550	13-14	PL-1003	PL-1003PK				
550	Sportsman 550	10-12	PL-1003	PL-1003PK				
550	Sportsman 550 EPs	10-14	PL-1003	PL-1003PK				

2) Requires Two; 3) Requires Three; 4) Requires Four. The use of custom air filter requires removal of air box. Some custom filters and intakes are not legal for sale or use on any pollution controlled motor vehicle in California or states adopting California emission procedures. See knfilters.com for CARB status on each part for a specific vehicle.

ATV - Application Listing



CC	Model	Year	Air Filter	Air Filter Precharger	Custom	Custom Precharger	Oil Filter	Comments
POLARIS								
550	Sportsman 550 EPs Browning	10	PL-1003	PL-1003PK				
550	Sportsman 550 EPs Browning	12	PL-1003	PL-1003PK				
550	Sportsman 550 EPS Orange Madness LE	12	PL-1003	PL-1003PK				
550	Sportsman 550 EPs Touring	10-14	PL-1003	PL-1003PK				
550	Sportsman 550 X2	10-14	PL-1003	PL-1003PK				
550	Sportsman 550 XP EFI	09-12	PL-5509	PL-1003PK				
550	Sportsman 550 XP EFI w/EPs	09-10	PL-5509	PL-1003PK				
550	Sportsman 550 XP LE-Browning	09-10	PL-5509	PL-1003PK				
567	Ace 570 SP	16					KN-198	
567	Ranger 570	15-16					KN-198	
567	Ranger 570 Crew	14-15					KN-198	
567	Ranger 570 Crew EPS	15					KN-198	
567	Ranger 570 Crew EPS Full Size	15					KN-198	
567	Ranger 570 Crew EPS LE	14					KN-198	
567	Ranger 570 Crew Full Size	15					KN-198	
567	Ranger 570 EFI	14					KN-198	
567	Ranger 570 EPS	15-16					KN-198	
567	Ranger 570 EPS Full Size	15-16					KN-198	
567	Ranger 570 EPS Hunter Edition	16					KN-198	
567	Ranger 570 EPS LE	14					KN-198	
567	Ranger 570 Full Size	15-16					KN-198	
567	Ranger 570 XP	16					KN-198	
567	Ranger 570 XP EPS	16					KN-198	
567	Ranger 570-4 Crew	16					KN-198	
567	Ranger 570-4 Crew EPS	16					KN-198	
567	Ranger 570-6 Crew	16					KN-198	
567	Ranger 570-6 Crew EPS	16					KN-198	
567	Ranger Crew	16					KN-198	
567	Ranger RZR 570	12-14	PL-5712				KN-198	
567	Ranger RZR 570 EPS Trail LE	13-14	PL-5712				KN-198	
567	RZR 570	14-15	PL-5712				KN-198	
567	RZR 570	16					KN-198	
567	RZR 570 EPS LE	14	PL-5712				KN-198	
567	RZR 570 EPS Trail	15	PL-5712				KN-198	
567	RZR 570 EPS Trail	16					KN-198	
567	RZR 570 EPS Trail LE	14	PL-5712				KN-198	
567	Sportsman 570	14-16	PL-1003	PL-1003PK				
567	Sportsman 570 EPS	14-16	PL-1003	PL-1003PK				
567	Sportsman 570 SP	15-16	PL-1003	PL-1003PK				
567	Sportsman 570 SP Hunters Edition	15-16	PL-1003	PL-1003PK				
567	Sportsman 570 Touring	14-16	PL-1003	PL-1003PK				
567	Sportsman 570 Touring EPS	15-16	PL-1003	PL-1003PK				
567	Sportsman 570 Touring SP	15-16	PL-1003	PL-1003PK				
567	Sportsman 570 X2 EPS	15-16	PL-1003	PL-1003PK				
567	Sportsman Ace 570	15-16	PL-3214	PL-3214DK				
570	Ace 570	16					KN-198	
597	Sportsman 600	03	PL-1003	PL-1003PK			KN-196	
597	Sportsman 600	04	PL-1003	PL-1003PK			KN-196*	*Built Before 10/2/03
597	Sportsman 600	04	PL-1003	PL-1003PK			KN-198*	*Built After 10/2/03
597	Sportsman 600	05	PL-1003	PL-1003PK			KN-198	
597	Sportsman 600	06					KN-198	
683	Ranger MVR5 700 4x4	08	PL-5008	PL-5008DK				
700	Ranger 6x6 700 EFI	06-09	PL-5008	PL-5008DK			KN-198	
700	Ranger Crew 700	08-09	PL-5008	PL-5008DK			KN-198	
700	Ranger HD	09	PL-5008	PL-5008DK			KN-198	

2) Requires Two; 3) Requires Three; 4) Requires Four. The use of custom air filter requires removal of air box. Some custom filters and intakes are not legal for sale or use on any pollution controlled motor vehicle in California or states adopting California emission procedures. See knfilters.com for CARB status on each part for a specific vehicle.



ATV - Application Listing

CC	Model	Year	Air Filter	Air Filter Precharger	Custom	Custom Precharger	Oil Filter	Comments
POLARIS								
700	Ranger XP	05-09	PL-5008	PL-5008DK			KN-198	
700	Sportsman 700	02-03	PL-1003	PL-1003PK			KN-196	
700	Sportsman 700	04	PL-1003	PL-1003PK			KN-196*	*Built Before 10/8/04
700	Sportsman 700	04	PL-1003	PL-1003PK			KN-198*	*Built After 10/8/04
700	Sportsman 700	05-06	PL-1003	PL-1003PK			KN-198	
700	Sportsman 700 EFI	04	PL-1003	PL-1003PK			KN-196	
700	Sportsman 700 EFI	05-07	PL-1003	PL-1003PK			KN-198	
700	Sportsman 700 EFI X2	08	PL-1003	PL-1003PK			KN-198	
700	Sportsman 700 MV	07	PL-1003	PL-1003PK			KN-198	
700	Sportsman 700 Twin Mossy Oak	04	PL-1003	PL-1003PK			KN-196	
700	Sportsman MV7	05	PL-1003	PL-1003PK			KN-198	
760	Ranger 6x6 800	10	PL-5008	PL-5008DK			KN-198	
760	Ranger 6x6 800	11-16	PL-8007	PL-8007DK			KN-198	
760	Ranger 800 EFI	13-14	PL-8007	PL-8007DK			KN-198	
760	Ranger 800 EFI EPS	13	PL-8007	PL-8007DK			KN-198	
760	Ranger 800 EFI EPS LE	13-14	PL-8007	PL-8007DK			KN-198	
760	Ranger 800 EFI LE	13	PL-8007	PL-8007DK			KN-198	
760	Ranger 800 EFI Mid-Size	13-14	PL-8007	PL-8007DK			KN-198	
760	Ranger 800 EFI Mid-Size LE	14	PL-8007	PL-8007DK			KN-198	
760	Ranger 800 HD	10	PL-5008	PL-5008DK			KN-198	
760	Ranger 800 HD EPS	11-12	PL-5008	PL-5008DK			KN-198	
760	Ranger 800 XP	10	PL-5008	PL-5008DK				
760	Ranger 800 XP	11-12	PL-8007	PL-8007DK			KN-198	
760	Ranger 800 XP EPS	11-12	PL-8007	PL-8007DK			KN-198	
760	Ranger 800 XP EPS LE	12	PL-8007	PL-8007DK			KN-198	
760	Ranger 800 XP LE	12	PL-8007	PL-8007DK			KN-198	
760	Ranger Crew 800	10	PL-5008	PL-5008DK			KN-198	
760	Ranger Crew 800	11-14	PL-8007	PL-8007DK			KN-198	
760	Ranger Crew 800 EPS	10	PL-5008	PL-5008DK			KN-198	
760	Ranger Crew 800 EPS	11-13	PL-8007	PL-8007DK			KN-198	
760	Ranger MVRS 800 4x4	08	PL-5008	PL-5008DK				
760	Ranger RZR 4 800	10-11	PL-8007	PL-8007DK	63-1120	62-1300DK	KN-198	
760	Ranger RZR 4 800	10-11	PL-8007	PL-8007DK	63-1120	RX-3810DK	KN-198	
760	Ranger RZR 4 800	10-11	PL-8007	PL-8007DK	63-1120	RX-3810DR	KN-198	
760	Ranger RZR 4 800	10-11	PL-8007	PL-8007DK	63-1120	RX-4730DK	KN-198	
760	Ranger RZR 4 800	10-11	PL-8007	PL-8007DK	63-1120	RX-4730DL	KN-198	
760	Ranger RZR 4 800	10-11	PL-8007	PL-8007DK	63-1120	RX-4730DR	KN-198	
760	Ranger RZR 4 800	10-11	PL-8007	PL-8007DK	63-1120	RX-4730DY	KN-198	
760	Ranger RZR 4 800	12-13	PL-8007	PL-8007DK			KN-198	
760	Ranger RZR 4 800 EPS LE	13	PL-8007	PL-8007DK			KN-198	
760	Ranger RZR 4 800 EPs Robby Gordon Edition	11	PL-8007	PL-8007DK	63-1120	62-1300DK	KN-198	
760	Ranger RZR 4 800 EPs Robby Gordon Edition	11	PL-8007	PL-8007DK	63-1120	RX-3810DK	KN-198	
760	Ranger RZR 4 800 EPs Robby Gordon Edition	11	PL-8007	PL-8007DK	63-1120	RX-3810DR	KN-198	
760	Ranger RZR 4 800 EPs Robby Gordon Edition	11	PL-8007	PL-8007DK	63-1120	RX-4730DK	KN-198	
760	Ranger RZR 4 800 EPs Robby Gordon Edition	11	PL-8007	PL-8007DK	63-1120	RX-4730DL	KN-198	
760	Ranger RZR 4 800 EPs Robby Gordon Edition	11	PL-8007	PL-8007DK	63-1120	RX-4730DR	KN-198	
760	Ranger RZR 4 800 EPs Robby Gordon Edition	11	PL-8007	PL-8007DK	63-1120	RX-4730DY	KN-198	
760	Ranger RZR 4 800 EPs Robby Gordon Edition	12	PL-8007	PL-8007DK			KN-198	
760	Ranger RZR 4 800 Gordon Edition	10-11	PL-8007	PL-8007DK	63-1120	62-1300DK	KN-198	
760	Ranger RZR 4 800 Gordon Edition	10-11	PL-8007	PL-8007DK	63-1120	RX-3810DK	KN-198	

2) Requires Two; 3) Requires Three; 4) Requires Four. The use of custom air filter requires removal of air box. Some custom filters and intakes are not legal for sale or use on any pollution controlled motor vehicle in California or states adopting California emission procedures. See knfilters.com for CARB status on each part for a specific vehicle.

ATV - Application Listing



CC	Model	Year	Air Filter	Air Filter Precharger	Custom	Custom Precharger	Oil Filter	Comments
POLARIS								
760	Ranger RZR 4 800 Gordon Edition	10-11	PL-8007	PL-8007DK	63-1120	RX-3810DR	KN-198	
760	Ranger RZR 4 800 Gordon Edition	10-11	PL-8007	PL-8007DK	63-1120	RX-4730DK	KN-198	
760	Ranger RZR 4 800 Gordon Edition	10-11	PL-8007	PL-8007DK	63-1120	RX-4730DL	KN-198	
760	Ranger RZR 4 800 Gordon Edition	10-11	PL-8007	PL-8007DK	63-1120	RX-4730DR	KN-198	
760	Ranger RZR 4 800 Gordon Edition	10-11	PL-8007	PL-8007DK	63-1120	RX-4730DY	KN-198	
760	Ranger RZR 4 800 Gordon Edition	12	PL-8007	PL-8007DK			KN-198	
760	Ranger RZR 4 Robby Gordon Edition	11	PL-8007	PL-8007DK	63-1120	62-1300DK	KN-198	
760	Ranger RZR 4 Robby Gordon Edition	11	PL-8007	PL-8007DK	63-1120	RX-3810DK	KN-198	
760	Ranger RZR 4 Robby Gordon Edition	11	PL-8007	PL-8007DK	63-1120	RX-3810DR	KN-198	
760	Ranger RZR 4 Robby Gordon Edition	11	PL-8007	PL-8007DK	63-1120	RX-4730DK	KN-198	
760	Ranger RZR 4 Robby Gordon Edition	11	PL-8007	PL-8007DK	63-1120	RX-4730DL	KN-198	
760	Ranger RZR 4 Robby Gordon Edition	11	PL-8007	PL-8007DK	63-1120	RX-4730DR	KN-198	
760	Ranger RZR 4 Robby Gordon Edition	11	PL-8007	PL-8007DK	63-1120	RX-4730DY	KN-198	
760	Ranger RZR 800	08-13	PL-8007	PL-8007DK	63-1120	62-1300DK	KN-198	
760	Ranger RZR 800	08-13	PL-8007	PL-8007DK	63-1120	RX-3810DK	KN-198	
760	Ranger RZR 800	08-13	PL-8007	PL-8007DK	63-1120	RX-3810DR	KN-198	
760	Ranger RZR 800	08-13	PL-8007	PL-8007DK	63-1120	RX-4730DK	KN-198	
760	Ranger RZR 800	08-13	PL-8007	PL-8007DK	63-1120	RX-4730DL	KN-198	
760	Ranger RZR 800	08-13	PL-8007	PL-8007DK	63-1120	RX-4730DR	KN-198	
760	Ranger RZR 800	08-13	PL-8007	PL-8007DK	63-1120	RX-4730DY	KN-198	
760	Ranger RZR 800	14	PL-8007	PL-8007DK			KN-198	
760	Ranger RZR 800 EPS LE	12	PL-8007	PL-8007DK			KN-198	
760	Ranger RZR 800 EPS LE	13	PL-8007	PL-8007DK	63-1120	62-1300DK	KN-198	
760	Ranger RZR 800 EPS LE	13	PL-8007	PL-8007DK	63-1120	RX-3810DK	KN-198	
760	Ranger RZR 800 EPS LE	13	PL-8007	PL-8007DK	63-1120	RX-3810DR	KN-198	
760	Ranger RZR 800 EPS LE	13	PL-8007	PL-8007DK	63-1120	RX-4730DK	KN-198	
760	Ranger RZR 800 EPS LE	13	PL-8007	PL-8007DK	63-1120	RX-4730DL	KN-198	
760	Ranger RZR 800 EPS LE	13	PL-8007	PL-8007DK	63-1120	RX-4730DR	KN-198	
760	Ranger RZR 800 EPS LE	13	PL-8007	PL-8007DK	63-1120	RX-4730DY	KN-198	
760	Ranger RZR 800 EPS LE	14	PL-8007	PL-8007DK			KN-198	
760	Ranger RZR 800 LE	12-13	PL-8007	PL-8007DK	63-1120	62-1300DK	KN-198	
760	Ranger RZR 800 LE	12-13	PL-8007	PL-8007DK	63-1120	RX-3810DK	KN-198	
760	Ranger RZR 800 LE	12-13	PL-8007	PL-8007DK	63-1120	RX-3810DR	KN-198	
760	Ranger RZR 800 LE	12-13	PL-8007	PL-8007DK	63-1120	RX-4730DK	KN-198	
760	Ranger RZR 800 LE	12-13	PL-8007	PL-8007DK	63-1120	RX-4730DL	KN-198	
760	Ranger RZR 800 LE	12-13	PL-8007	PL-8007DK	63-1120	RX-4730DR	KN-198	
760	Ranger RZR 800 LE	12-13	PL-8007	PL-8007DK	63-1120	RX-4730DY	KN-198	
760	Ranger RZR 800 S	12-13	PL-8007	PL-8007DK	63-1120	62-1300DK	KN-198	
760	Ranger RZR 800 S	12-13	PL-8007	PL-8007DK	63-1120	RX-3810DK	KN-198	
760	Ranger RZR 800 S	12-13	PL-8007	PL-8007DK	63-1120	RX-3810DR	KN-198	
760	Ranger RZR 800 S	12-13	PL-8007	PL-8007DK	63-1120	RX-4730DK	KN-198	
760	Ranger RZR 800 S	12-13	PL-8007	PL-8007DK	63-1120	RX-4730DL	KN-198	
760	Ranger RZR 800 S	12-13	PL-8007	PL-8007DK	63-1120	RX-4730DR	KN-198	
760	Ranger RZR 800 S	12-13	PL-8007	PL-8007DK	63-1120	RX-4730DY	KN-198	
760	Ranger RZR 800 S	14	PL-8007	PL-8007DK			KN-198	
760	Ranger RZR 800 S LE	12-13	PL-8007	PL-8007DK	63-1120	62-1300DK	KN-198	
760	Ranger RZR 800 S LE	12-13	PL-8007	PL-8007DK	63-1120	RX-3810DK	KN-198	
760	Ranger RZR 800 S LE	12-13	PL-8007	PL-8007DK	63-1120	RX-3810DR	KN-198	
760	Ranger RZR 800 S LE	12-13	PL-8007	PL-8007DK	63-1120	RX-4730DK	KN-198	
760	Ranger RZR 800 S LE	12-13	PL-8007	PL-8007DK	63-1120	RX-4730DL	KN-198	
760	Ranger RZR 800 S LE	12-13	PL-8007	PL-8007DK	63-1120	RX-4730DR	KN-198	
760	Ranger RZR 800 S LE	12-13	PL-8007	PL-8007DK	63-1120	RX-4730DY	KN-198	
760	Ranger RZR 800 SW Military	11	PL-8007	PL-8007DK	63-1120	62-1300DK	KN-198	
760	Ranger RZR 800 SW Military	11	PL-8007	PL-8007DK	63-1120	RX-3810DK	KN-198	
760	Ranger RZR 800 SW Military	11	PL-8007	PL-8007DK	63-1120	RX-3810DR	KN-198	

2) Requires Two; 3) Requires Three; 4) Requires Four. The use of custom air filter requires removal of air box. Some custom filters and intakes are not legal for sale or use on any pollution controlled motor vehicle in California or states adopting California emission procedures. See knfilters.com for CARB status on each part for a specific vehicle.



ATV - Application Listing

CC	Model	Year	Air Filter	Air Filter Precharger	Custom	Custom Precharger	Oil Filter	Comments
POLARIS								
760	Ranger RZR 800 SW Military	11	PL-8007	PL-8007DK	63-1120	RX-4730DK	KN-198	
760	Ranger RZR 800 SW Military	11	PL-8007	PL-8007DK	63-1120	RX-4730DL	KN-198	
760	Ranger RZR 800 SW Military	11	PL-8007	PL-8007DK	63-1120	RX-4730DR	KN-198	
760	Ranger RZR 800 SW Military	11	PL-8007	PL-8007DK	63-1120	RX-4730DY	KN-198	
760	Ranger RZR S	09-11	PL-8007	PL-8007DK	63-1120	62-1300DK	KN-198	
760	Ranger RZR S	09-11	PL-8007	PL-8007DK	63-1120	RX-3810DK	KN-198	
760	Ranger RZR S	09-11	PL-8007	PL-8007DK	63-1120	RX-3810DR	KN-198	
760	Ranger RZR S	09-11	PL-8007	PL-8007DK	63-1120	RX-4730DK	KN-198	
760	Ranger RZR S	09-11	PL-8007	PL-8007DK	63-1120	RX-4730DL	KN-198	
760	Ranger RZR S	09-11	PL-8007	PL-8007DK	63-1120	RX-4730DR	KN-198	
760	Ranger RZR S	09-11	PL-8007	PL-8007DK	63-1120	RX-4730DY	KN-198	
760	Ranger RZR S 800 EPS LE	12-13	PL-8007	PL-8007DK	63-1120	62-1300DK	KN-198	
760	Ranger RZR S 800 EPS LE	12-13	PL-8007	PL-8007DK	63-1120	RX-3810DK	KN-198	
760	Ranger RZR S 800 EPS LE	12-13	PL-8007	PL-8007DK	63-1120	RX-3810DR	KN-198	
760	Ranger RZR S 800 EPS LE	12-13	PL-8007	PL-8007DK	63-1120	RX-4730DK	KN-198	
760	Ranger RZR S 800 EPS LE	12-13	PL-8007	PL-8007DK	63-1120	RX-4730DL	KN-198	
760	Ranger RZR S 800 EPS LE	12-13	PL-8007	PL-8007DK	63-1120	RX-4730DR	KN-198	
760	Ranger RZR S 800 EPS LE	12-13	PL-8007	PL-8007DK	63-1120	RX-4730DY	KN-198	
760	Ranger RZR S 800 EPS LE	14	PL-8007	PL-8007DK			KN-198	
760	Ranger RZR S Military	12	PL-8007	PL-8007DK	63-1120	62-1300DK	KN-198	
760	Ranger RZR S Military	12	PL-8007	PL-8007DK	63-1120	RX-3810DK	KN-198	
760	Ranger RZR S Military	12	PL-8007	PL-8007DK	63-1120	RX-3810DR	KN-198	
760	Ranger RZR S Military	12	PL-8007	PL-8007DK	63-1120	RX-4730DK	KN-198	
760	Ranger RZR S Military	12	PL-8007	PL-8007DK	63-1120	RX-4730DL	KN-198	
760	Ranger RZR S Military	12	PL-8007	PL-8007DK	63-1120	RX-4730DR	KN-198	
760	Ranger RZR S Military	12	PL-8007	PL-8007DK	63-1120	RX-4730DY	KN-198	
760	RZR 4 800 EPS LE	14	PL-8007	PL-8007DK			KN-198	
760	RZR 800	14	PL-8007	PL-8007DK			KN-198	
760	RZR 800 EPS LE	14	PL-8007	PL-8007DK			KN-198	
760	RZR 800 XC Edition	14	PL-8007	PL-8007DK			KN-198	
760	RZR S 800	14	PL-8007	PL-8007DK			KN-198	
760	RZR S 800 EPS LE	14	PL-8007	PL-8007DK			KN-198	
769	Sportsman 800 EFI	08	PL-1003	PL-1003PK			KN-198	
769	Sportsman 800 EFI HO	07					KN-198	
769	Sportsman 800 EFI HO	08-09	PL-1003	PL-1003PK			KN-198	
769	Sportsman 800 EFI Le	08	PL-1003	PL-1003PK			KN-198	
769	Sportsman 800 EFI Touring	08-09	PL-1003	PL-1003PK			KN-198	
769	Sportsman 800 EFI X2	07-09	PL-1003	PL-1003PK			KN-198	
769	Sportsman 800 EFI X2 LE	08	PL-1003	PL-1003PK			KN-198	
769	Sportsman 800 HO EFI Military	08	PL-1003	PL-1003PK			KN-198	
794	Sportsman 800 Twin	05					KN-198	
794	Sportsman 800 Twin EFI	05	PL-1003	PL-1003PK			KN-198	
800	Sportsman 800 Big Boss 6x6	12-14	PL-1003	PL-1003PK			KN-198	
800	Sportsman 800 EFI	06-07	PL-1003	PL-1003PK			KN-198	
800	Sportsman 800 EFI	09-14	PL-1003	PL-1003PK			KN-198	
800	Sportsman 800 EFI 6x6	10-11	PL-1003	PL-1003PK			KN-198	
800	Sportsman 800 EFI 6x6 Big Boss	09	PL-1003	PL-1003PK			KN-198	
800	Sportsman 800 EFI 6x6 Big Boss	12	PL-1003	PL-1003PK			KN-198	
850	Scrambler 850	15-16	PL-1003	PL-1003PK				
850	Scrambler 850 XP HO	13-14	PL-1003	PL-1003PK				
850	Scrambler 850 XP HO EPS LE	13-14	PL-1003	PL-1003PK				
850	Sportsman 850	15-16	PL-1003	PL-1003PK				
850	Sportsman 850 High Lifter Edition	16	PL-1003	PL-1003PK				
850	Sportsman 850 HO Touring EPS Bronze Mist LE	12	PL-5509	PL-1003PK				

2) Requires Two; 3) Requires Three; 4) Requires Four. The use of custom air filter requires removal of air box. Some custom filters and intakes are not legal for sale or use on any pollution controlled motor vehicle in California or states adopting California emission procedures. See knfilters.com for CARB status on each part for a specific vehicle.

ATV - Application Listing



CC	Model	Year	Air Filter	Air Filter Precharger	Custom	Custom Precharger	Oil Filter	Comments
POLARIS								
850	Sportsman 850 HO Touring EPS Bronze Mist LE	14	PL-1003	PL-1003PK				
850	Sportsman 850 HO Touring EPS Sunset Red LE	13	PL-1003	PL-1003PK				
850	Sportsman 850 HO XP EPS	12	PL-5509	PL-1003PK				
850	Sportsman 850 HO XP EPS Browning LE	12-13	PL-5509	PL-1003PK				
850	Sportsman 850 HO XP EPS Orange Madness LE	12	PL-5509	PL-1003PK				
850	Sportsman 850 HO XP EPS Pearl White LE	14	PL-5509	PL-1003PK				
850	Sportsman 850 HO XP EPS Stealth Black LE	13	PL-5509	PL-1003PK				
850	Sportsman 850 SP	15-16	PL-1003	PL-1003PK				
850	Sportsman 850 Touring EPs	10-11	PL-1003	PL-1003PK				
850	Sportsman 850 Touring H.O. EPs	12-14	PL-1003	PL-1003PK				
850	Sportsman 850 Touring SP	15-16	PL-1003	PL-1003PK				
850	Sportsman 850 XP	10	PL-5509	PL-1003PK				
850	Sportsman 850 XP EFI	09-11	PL-5509	PL-1003PK				
850	Sportsman 850 XP EPs	10-11	PL-5509	PL-1003PK				
850	Sportsman 850 XP EPs Browning	10	PL-5509	PL-1003PK				
850	Sportsman 850 XP H.O.	12-13	PL-5509	PL-1003PK				
850	Sportsman 850 XP H.O. EPs	13-14	PL-5509	PL-1003PK				
850	Sportsman 850 XP LE-Browning	09-10	PL-5509	PL-1003PK				
850	Sportsman 850 XP LE-Browning	14	PL-5509	PL-1003PK				
850	Sportsman 850 XP LE-Nuclear Sunset	09-10	PL-5509	PL-1003PK				
875	Ace 900 SP	16					KN-198	
875	Ranger 900 Crew	14	PL-5712				KN-198	
875	Ranger 900 Crew	15	PL-5712					
875	Ranger 900 Crew	16	PL-5712				KN-198	
875	Ranger 900 Crew EPS	14	PL-5712				KN-198	
875	Ranger 900 Crew EPS	15	PL-5712					
875	Ranger 900 Crew EPS LE	14	PL-5712				KN-198	
875	Ranger 900 XP	13-14	PL-5712				KN-198	
875	Ranger 900 XP	15	PL-5712					
875	Ranger 900 XP	16	PL-5712				KN-198	
875	Ranger 900 XP Deluxe	14	PL-5712				KN-198	
875	Ranger 900 XP EPS	14	PL-5712				KN-198	
875	Ranger 900 XP EPS	15	PL-5712					
875	Ranger 900 XP EPS	16	PL-5712				KN-198	
875	Ranger 900 XP EPS Browning LE	14	PL-5712				KN-198	
875	Ranger 900 XP EPS Deluxe	15	PL-5712					
875	Ranger 900 XP EPS High Lifter Edition	16	PL-5712				KN-198	
875	Ranger 900 XP EPS Hunter Deluxe Edition	15	PL-5712					
875	Ranger 900 XP EPS Hunter Deluxe Edition	16	PL-5712				KN-198	
875	Ranger 900 XP EPS Hunter Edition	15	PL-5712					
875	Ranger 900 XP EPS Hunter Edition	16	PL-5712				KN-198	
875	Ranger 900 XP EPS LE	14	PL-5712				KN-198	
875	Ranger 900 XP EPS LE	15	PL-5712					
875	Ranger 900 XP EPS Northstar Edition	15	PL-5712					
875	Ranger 900 XP EPS Northstar Edition	16	PL-5712				KN-198	
875	Ranger 900 XP EPS Trail Edition	16	PL-5712				KN-198	
875	Ranger 900-5 Crew	16					KN-198	
875	Ranger 900-5 Crew EPS	16					KN-198	
875	Ranger 900-6 Crew	15	PL-5712					
875	Ranger 900-6 Crew	16					KN-198	
875	Ranger 900-6 Crew EPS	15	PL-5712					
875	Ranger 900-6 Crew EPS	16					KN-198	
875	Ranger Crew 900	15	PL-5712				KN-198	

2) Requires Two; 3) Requires Three; 4) Requires Four. The use of custom air filter requires removal of air box. Some custom filters and intakes are not legal for sale or use on any pollution controlled motor vehicle in California or states adopting California emission procedures. See knfilters.com for CARB status on each part for a specific vehicle.



ATV - Application Listing

CC	Model	Year	Air Filter	Air Filter Precharger	Custom	Custom Precharger	Oil Filter	Comments
POLARIS								
875	Ranger RZR XP 4 900	12-13	PL-9011		63-1129	RC-5062DK	KN-198	
875	Ranger RZR XP 4 900 EPS LE	12-13	PL-9011		63-1129	RC-5062DK	KN-198	
875	Ranger RZR XP 900	11-13	PL-9011		63-1129	RC-5062DK	KN-198	
875	Ranger RZR XP 900 EPS LE	13	PL-9011		63-1129	RC-5062DK	KN-198	
875	Ranger RZR XP 900 EPS Walker Evans LE	13	PL-9011		63-1129	RC-5062DK	KN-198	
875	Ranger RZR XP 900 HO Jagged X Edition	13	PL-9011		63-1129	RC-5062DK	KN-198	
875	Ranger RZR XP 900 LE	11-13	PL-9011		63-1129	RC-5062DK	KN-198	
875	RZR 4 900 EPS	15-16	PL-8715	PL-1014-1DK			KN-198	
875	RZR 4 900 EPS LE	14	PL-9011		63-1129	RC-5062DK	KN-198	
875	RZR 900	14	PL-9011		63-1129	RC-5062DK	KN-198	
875	RZR 900	15-16	PL-8715	PL-1014-1DK			KN-198	
875	RZR 900 EPS LE	14	PL-9011		63-1129	RC-5062DK	KN-198	
875	RZR 900 EPS Trail	15-16	PL-8715	PL-1014-1DK			KN-198	
875	RZR 900 EPS Trail Fox Edition LE	16	PL-8715	PL-1014-1DK			KN-198	
875	RZR 900 XC Edition	15-16	PL-8715	PL-1014-1DK			KN-198	
875	RZR S 900	15-16	PL-8715	PL-1014-1DK			KN-198	
875	RZR S 900 EPS	15-16	PL-8715	PL-1014-1DK			KN-198	
875	Sportsman Ace 900 SP	16	PL-8715	PL-1014-1DK			KN-198	
904	Ranger Crew DSL	12-14	PL-8007	PL-8007DK				
904	Ranger DSL	11-14	PL-8007	PL-8007DK				
925	RZR XP 4 Turbo EPS	16			63-1136			
925	RZR XP Turbo	16	PL-1014	PL-1014-1DK	63-1136		KN-198	
999	General 1000 EPS	16	PL-8715	PL-1014-1DK			KN-198	
999	General 1000 EPS Deluxe	16	PL-8715	PL-1014-1DK			KN-198	
999	RZR S 1000 EPS	16	PL-8715	PL-1014-1DK	63-1133		KN-198	
999	RZR XP 1000 B	17			63-1133			
999	RZR XP 1000 EPS	14-16	PL-1014	PL-1014-1DK	63-1133		KN-198	
999	RZR XP 1000 EPS	17			63-1133			
999	RZR XP 1000 EPS Desert Edition	15	PL-1014	PL-1014-1DK	63-1133		KN-198	
999	RZR XP 1000 EPS Fox Edition	15	PL-1014	PL-1014-1DK			KN-198	
999	RZR XP 1000 EPS High Lifter Edition	15-16	PL-1014	PL-1014-1DK	63-1133		KN-198	
999	RZR XP 1000 EPS High Lifter Edition	17			63-1133			
999	RZR XP 4 1000 EPS	14-16	PL-1014	PL-1014-1DK	63-1133		KN-198	
999	RZR XP 4 1000 EPS	17			63-1133			
999	RZR XP 4 1000 EPS High Lifter Ed.	17			63-1133			
SUZUKI								
80	LT80 QuadSport	87-06	SU-8087					
90	LTZ90 QuadSport	07-09					KN-131	
90	LTZ90 QuadSport	16					KN-139	
125	ALT125	83-86					KN-131	
125	LT125	83-87					KN-131	
160	LT160 Quadrunner	03	SU-1691	25-1691			KN-132	
160	LT160 QuadSport	03					KN-132	
160	LT160 QuadSport	04	SU-1691	25-1691			KN-132	
160	LT160E Quadrunner	89-92	SU-1691	25-1691			KN-132	
160	LTF160 Quadrunner	91-01	SU-1691	25-1691			KN-132	
160	LTF160 Quadrunner	02					KN-132	
185	ALT185	84-85					KN-131	
185	LT185	84-87					KN-131	
230	LT230E Quadrunner	86					KN-132	
230	LT230E Quadrunner	87-93	SU-2391				KN-132	
230	LT230G	85-86	SU-2391				KN-132	
230	LT230G	87					KN-132	
230	LT230S QuadSport	85-88	SU-4230				KN-132	
230	LTF230	86-87	SU-2391				KN-132	

2) Requires Two; 3) Requires Three; 4) Requires Four. The use of custom air filter requires removal of air box. Some custom filters and intakes are not legal for sale or use on any pollution controlled motor vehicle in California or states adopting California emission procedures. See knfilters.com for CARB status on each part for a specific vehicle.

ATV - Application Listing



CC	Model	Year	Air Filter	Air Filter Precharger	Custom	Custom Precharger	Oil Filter	Comments
SUZUKI								
246	LTZ250 QuadSport Z	04-09	SU-2504	SU-2504PK			KN-132	
249	LTF250 Ozark	12-14	SU-2504	SU-2504PK			KN-132	
250	LT250 Quadrunner 2x4	88-02	SU-2588	25-2588			KN-132	
250	LT250 Quadrunner 2x4	88-02	SU-2588	AC-3098PK			KN-132	
250	LT250E	85-86					KN-132	
250	LT250R Quadracer	85-92	SU-4250	SU-4250PY				
250	LT250S	89-90					KN-132	
250	LTF250 Ozark	02-09	SU-2504	SU-2504PK			KN-132	
250	LTF250 Quadrunner 2x4	99-01	SU-2588	25-2588			KN-132	
250	LTF250 Quadrunner 2x4	99-01	SU-2588	AC-3098PK			KN-132	
250	LTF250 Quadrunner 4x4	88-02	SU-2588	25-2588			KN-132	
250	LTF250 Quadrunner 4x4	88-02	SU-2588	AC-3098PK			KN-132	
300	LT300E	87-89					KN-132	
300	LT4WD	87-99					KN-132	
300	LTF300 King Quad	91-02	SU-2588	25-2588			KN-132	
300	LTF300 King Quad	91-02	SU-2588	AC-3098PK			KN-132	
376	LTA400F KingQuad ASi	12-15	SU-5002	SU-4002PK			KN-138*	*Chrome=KN-138C
376	LTA400F KingQuad ASi	16					KN-138*	*Chrome=KN-138C
376	LTA400F KingQuad ASi LE	14	SU-5002	SU-4002PK			KN-138*	*Chrome=KN-138C
376	LTA400F KingQuad ASi LE	16					KN-138*	*Chrome=KN-138C
376	LTA400F KingQuad Auto 4x4	12	SU-5002	SU-4002PK			KN-138*	*Chrome=KN-138C
376	LTF400F KingQuad 4x4	12	SU-5002	SU-4002PK			KN-138*	*Chrome=KN-138C
376	LTF400F KingQuad FSi	13-16	SU-5002	SU-4002PK			KN-138*	*Chrome=KN-138C
376	LTF400F KingQuad FSi LE	14	SU-5002	SU-4002PK			KN-138*	*Chrome=KN-138C
398	LTZ400 QuadSport Z	03-09	SU-4002	SU-4002PK	SU-4002-T	SU-4002-TDK	KN-139	
398	LTZ400 QuadSport Z	12-13	SU-4002	SU-4002PK	SU-4002-T	SU-4002-TDK	KN-139	
398	LTZ400 QuadSport Z LE	08	SU-4002	SU-4002PK	SU-4002-T	SU-4002-TDK	KN-139	
398	LTZ400 QuadSport Z LE	12	SU-4002	SU-4002PK	SU-4002-T	SU-4002-TDK	KN-139	
400	LTA400 Eiger Auto 2x4	02-04	SU-5002	SU-4002PK			KN-138*	*Chrome=KN-138C
400	LTA400 Eiger Auto 2x4	06	SU-5002	SU-4002PK			KN-138*	*Chrome=KN-138C
400	LTA400F Eiger Auto 4x4	02-07	SU-5002	SU-4002PK			KN-138*	*Chrome=KN-138C
400	LTA400F Eiger Auto 4x4 Camo	04-07	SU-5002	SU-4002PK			KN-138*	*Chrome=KN-138C
400	LTA400F Eiger Auto 4x4 Hunter X Hunter	07	SU-5002	SU-4002PK			KN-138*	*Chrome=KN-138C
400	LTA400F KingQuad AS	10	SU-5002	SU-4002PK			KN-138*	*Chrome=KN-138C
400	LTA400F KingQuad Auto 4x4	08-09	SU-5002	SU-4002PK			KN-138*	*Chrome=KN-138C
400	LTA400F KingQuad Auto 4x4	11	SU-5002	SU-4002PK			KN-138*	*Chrome=KN-138C
400	LTA400F KingQuad Auto 4x4 Camo	08-10	SU-5002	SU-4002PK			KN-138*	*Chrome=KN-138C
400	LTF400 Eiger 2x4	02-04	SU-5002	SU-4002PK			KN-138*	*Chrome=KN-138C
400	LTF400F Eiger 4x4	02-07	SU-5002	SU-4002PK			KN-138*	*Chrome=KN-138C
400	LTF400F Eiger 4x4 Camo	05-07	SU-5002	SU-4002PK			KN-138*	*Chrome=KN-138C
400	LTF400F KingQuad 4x4	08-09	SU-5002	SU-4002PK			KN-138*	*Chrome=KN-138C
400	LTF400F KingQuad 4x4	11	SU-5002	SU-4002PK			KN-138*	*Chrome=KN-138C
400	LTF400F KingQuad 4x4 Camo	08-11	SU-5002	SU-4002PK			KN-138*	*Chrome=KN-138C
400	LTF400F KingQuad FS	10					KN-138*	*Chrome=KN-138C
450	LTA450X KingQuad 4x4	07	SU-7005	SU-7005DK			KN-138*	*Chrome=KN-138C
450	LTA450X KingQuad 4x4 Camo	07	SU-7005	SU-7005DK			KN-138*	*Chrome=KN-138C
450	LTA450X KingQuad AXi 4x4	07-10	SU-7005	SU-7005DK			KN-138*	*Chrome=KN-138C
450	LTA450X KingQuad AXi 4x4 Camo	08-09	SU-7005	SU-7005DK			KN-138*	*Chrome=KN-138C
450	LTR450 QuadRacer	06-08	SU-4506	SU-4506DK	63-1128	RC-5182DK	KN-139	
450	LTR450 QuadRacer	09	SU-4506	SU-4506DK			KN-139	
450	LTR450 QuadRacer Limited Edition	08	SU-4506	SU-4506DK			KN-139	
500	LTA500 F Quadrunner	98					KN-138*	*Chrome=KN-138C
500	LTA500 KingQuad AXi	15-16					KN-138*	*Chrome=KN-138C
500	LTA500 KingQuad AXi PS	16					KN-138*	*Chrome=KN-138C
500	LTA500 KingQuad AXi PS SE	16					KN-138*	*Chrome=KN-138C

2) Requires Two; 3) Requires Three; 4) Requires Four. The use of custom air filter requires removal of air box. Some custom filters and intakes are not legal for sale or use on any pollution controlled motor vehicle in California or states adopting California emission procedures. See knfilters.com for CARB status on each part for a specific vehicle.



ATV - Application Listing

CC	Model	Year	Air Filter	Air Filter Precharger	Custom	Custom Precharger	Oil Filter	Comments
SUZUKI								
500	LTA500 Quadmaster	00-01	SU-5098	SU-5098PY			KN-138*	*Chrome=KN-138C
500	LTA500F Vinson Auto 4x4	02-07	SU-5002	SU-4002PK			KN-138*	*Chrome=KN-138C
500	LTA500XP KingQuad AXI PS	09	SU-7005	SU-7005DK			KN-138*	*Chrome=KN-138C
500	LTA500XP KingQuad AXI PS	10					KN-138*	*Chrome=KN-138C
500	LTA500XP KingQuad AXI PS	11-14	SU-7005	SU-7005DK			KN-138*	*Chrome=KN-138C
500	LTA500XP KingQuad AXI PS	15					KN-138*	*Chrome=KN-138C
500	LTF500F Quadrunner	98-02	SU-5098	SU-5098PY			KN-138*	*Chrome=KN-138C
500	LTF500F Vinson 4x4	02					KN-138*	*Chrome=KN-138C
500	LTF500F Vinson 4x4	03-07	SU-5002	SU-4002PK			KN-138*	*Chrome=KN-138C
500	LTF500F Vinson 4x4 Camo	05-07	SU-5002	SU-4002PK			KN-138*	*Chrome=KN-138C
638	Burgman 650 ABS	15					KN-138*	*Chrome=KN-138C
700	LTA700X KingQuad 4x4	05-07	SU-7005	SU-7005DK			KN-138*	*Chrome=KN-138C
700	LTA700X KingQuad 4x4	08					KN-138*	*Chrome=KN-138C
700	LTA700X KingQuad 4x4 Camo	06-07	SU-7005	SU-7005DK			KN-138*	*Chrome=KN-138C
700	LTV700 Twin Peaks 4x4	04-05	KA-6503	KA-6503PK			KN-204*	*Chrome=KN-204C
700	LTV700 Twin Peaks 4x4	06					KN-204*	*Chrome=KN-204C
750	LTA750 KingQuad AXi PS	11	SU-7005	SU-7005DK			KN-138*	*Chrome=KN-138C
750	LTA750 KingQuad AXi PS	14-16	SU-7005	SU-7005DK			KN-138*	*Chrome=KN-138C
750	LTA750 KingQuad AXi PS LE	14-15	SU-7005	SU-7005DK			KN-138*	*Chrome=KN-138C
750	LTA750 KingQuad AXi PS SE	16	SU-7005	SU-7005DK			KN-138*	*Chrome=KN-138C
750	LTA750X KingQuad AXi 4x4	08-09	SU-7005	SU-7005DK			KN-138*	*Chrome=KN-138C
750	LTA750X KingQuad AXi 4x4	11-16	SU-7005	SU-7005DK			KN-138*	*Chrome=KN-138C
750	LTA750X KingQuad AXi 4x4 LE	14	SU-7005	SU-7005DK			KN-138*	*Chrome=KN-138C
YAMAHA								
50	YFM50 Raptor	04-08	YA-8002					
80	YFM80 Badger	85-88	YA-8002					
80	YFM80 Badger	92-00	YA-8002					
80	YFM80 Grizzly	05-08	YA-8002					
80	YFM80 Raptor	02-08	YA-8002					
124	YFA125 Breeze	89-04	YA-2088	YA-2088PK				
124	YFM125 Grizzly	04-09	YA-2088	YA-2088PK				
124	YFM125 Grizzly	11-13	YA-2088	YA-2088PK				
124	YFM125 Raptor	11-13	YA-2088	YA-2088PK				
195	YFM250 Moto-4	90	YA-2597	YA-2597PK			KN-143	
200	YFM200 Moto-4	85-89					KN-143	
200	YFS200 Blaster	88-06	YA-2088	YA-2088PK				
200	YTM200 Tri-Moto	83-85					KN-143	
225	YFM225 Moto-4	86-90					KN-143	
225	YTM225 Tri-Moto	83-86			RU-1030	RU-0510PK	KN-143	
230	YFB250 Timberwolf	92-98	YA-2597	YA-2597PK			KN-143	
230	YFB250FW Timberwolf 4x4	94-00	YA-2597	YA-2597PK			KN-143	
230	YFM230 Bear Tracker	03-04					KN-143	
230	YFM250 Bear Tracker	98					KN-143	
230	YFM250 Bear Tracker	99-03	YA-4001	YA-4001PK			KN-143	
230	YFM250 Big Bear	07-09	YA-4001	YA-4001PK			KN-143	
230	YFM250 Bruin	05-06	YA-4001	YA-4001PK			KN-143	
249	YFM250 Raptor	08-13	YA-2088	YA-2088PK			KN-140	
249	YFM250 Raptor SE	08	YA-2088	YA-2088PK			KN-140	
249	YFM250 Raptor SE Custom	08	YA-2088	YA-2088PK			KN-140	
249	YFM250R Raptor	11	YA-2088	YA-2088PK			KN-140	
250	YFM250 Bear Tracker	91-97					KN-143	
250	YFM250 Bear Tracker	04	YA-4001	YA-4001PK			KN-143	
250	YFM250 Moto-4	89	YA-2597	YA-2597PK			KN-143	
250	YFM250 Moto-4	91	YA-2597	YA-2597PK			KN-143	
250	YFM250 Moto-4	92-93					KN-143	

2) Requires Two; 3) Requires Three; 4) Requires Four. The use of custom air filter requires removal of air box. Some custom filters and intakes are not legal for sale or use on any pollution controlled motor vehicle in California or states adopting California emission procedures. See knfilters.com for CARB status on each part for a specific vehicle.

ATV - Application Listing



CC	Model	Year	Air Filter	Air Filter Precharger	Custom	Custom Precharger	Oil Filter	Comments
YAMAHA								
250	YTZ250 Tri-Moto	85-86	YA-3250					
250	YTZ250 Tri-Z	85-86	YA-3250					
346	YFM350 Grizzly Auto 2x4	07-09	YA-3504	YA-3504PK			KN-204*	*Chrome=KN-204C
346	YFM350 Grizzly Auto 4x4	07-09	YA-3504	YA-3504PK			KN-204*	*Chrome=KN-204C
346	YFM350 Grizzly Auto 4x4 IRS	07-09	YA-3504	YA-3504PK			KN-204*	*Chrome=KN-204C
346	YFM350 Moto-4	90-95	YA-2597	YA-2597PK			KN-142	
346	YFM350FW Big Bear	90-98	YA-2597	YA-2597PK			KN-142	
348	YFM350R Raptor	08	YA-6602	YA-4350PK			KN-142	
350	YFM350	96					KN-142	
350	YFM350 Bruin Auto 2x4	04-06	YA-3504	YA-3504PK			KN-303*	*Chrome=KN-303C
350	YFM350 Bruin Auto 4x4	04-06	YA-3504	YA-3504PK			KN-303*	*Chrome=KN-303C
350	YFM350 Bruin Auto 4x4 Hunter	05	YA-3504	YA-3504PK			KN-303*	*Chrome=KN-303C
350	YFM350 Grizzly Auto	12	YA-3504	YA-3504PK			KN-204*	*Chrome=KN-204C
350	YFM350 Grizzly Auto	14	YA-3504	YA-3504PK			KN-204*	*Chrome=KN-204C
350	YFM350 Grizzly Auto 2x4	10-11	YA-3504	YA-3504PK			KN-204*	*Chrome=KN-204C
350	YFM350 Grizzly Auto 4x4	10-14	YA-3504	YA-3504PK			KN-204*	*Chrome=KN-204C
350	YFM350 Grizzly Auto 4x4 IRS	10-12	YA-3504	YA-3504PK			KN-204*	*Chrome=KN-204C
350	YFM350 Moto-4	87-89	YA-2597	YA-2597PK			KN-142	
350	YFM350FW Big Bear	86-89	YA-2597	YA-2597PK			KN-142	
350	YFM350FX Wolverine	94-05	YA-4350	YA-4350PK			KN-142	
350	YFM350R Raptor	04-07	YA-6602	YA-4350PK			KN-142	
350	YFM350R Raptor	09-13	YA-6602	YA-4350PK			KN-142	
350	YFM350X Warrior	87-04	YA-4350	YA-4350PK			KN-142	
350	YFM350X Wolverine 2x4	06-09	YA-3504	YA-3504PK			KN-204*	*Chrome=KN-204C
350	YFP350 TerraPro	88	YA-2597	YA-2597PK			KN-142	
350	YFZ350 Banshee	87-02	YA-3502	YA-3502DK	RU-0210 ²	RU-0210PK		
350	YFZ350 Banshee	87-06	YA-3502	YA-3502DK	YA-3502-T	YA-3502-TDK		
384	YFM350FW Big Bear	99	YA-2597	YA-2597PK			KN-142	
384	YFM400 Big Bear	00	YA-4001	YA-4001PK			KN-142	
384	YFM400 Big Bear	04	YA-4001	YA-4001PK			KN-142	
384	YFM400 Big Bear 4x4	00	YA-4001	YA-4001PK			KN-142	
384	YFM400 Big Bear 4x4	04-06	YA-4001	YA-4001PK			KN-142	
384	YFM400 Kodiak Auto 2x4	04	YA-3504	YA-3504PK			KN-303*	*Chrome=KN-303C
384	YFM400 Kodiak Auto 4x4	04-06	YA-3504	YA-3504PK			KN-303*	*Chrome=KN-303C
393	YFM400 Kodiak Auto 2x4	00-01	YA-4000				KN-303*	*Chrome=KN-303C
393	YFM400 Kodiak Auto 2x4	03	YA-4003	KA-3603PK			KN-303*	*Chrome=KN-303C
393	YFM400 Kodiak Auto 4x4	00-01	YA-4000				KN-303*	*Chrome=KN-303C
393	YFM400 Kodiak Auto 4x4	03	YA-4003	KA-3603PK			KN-303*	*Chrome=KN-303C
393	YFM400A Kodiak	02	YA-4000				KN-303*	*Chrome=KN-303C
393	YFM400F Kodiak	02	YA-4000				KN-303*	*Chrome=KN-303C
400	YFM400 Big Bear	93-99					KN-142	
400	YFM400 Big Bear	01-03	YA-4001	YA-4001PK			KN-142	
400	YFM400 Big Bear 4x4	01-03	YA-4001	YA-4001PK			KN-142	
400	YFM400 Big Bear IRS 4x4	07-12	YA-4001	YA-4001PK			KN-142	
400	YFM400 Grizzly Auto 4x4	07-08	YA-3504	YA-3504PK			KN-204*	*Chrome=KN-204C
401	YFM400F Kodiak	93-99	YA-2597	YA-2597PK			KN-142	
416	YFM450 Kodiak Auto 4x4	04	YA-4003	KA-3603PK			KN-303*	*Chrome=KN-303C
416	YFM450 Kodiak Auto 4x4	05-06	YA-3504	YA-3504PK			KN-303*	*Chrome=KN-303C
449	YFZ450	04-06	YA-4504	YA-4504PK	63-1123	RX-4990DK	KN-141	
449	YFZ450	04-06	YA-4504	YA-4504PK	63-1123	RX-4990DL	KN-141	
449	YFZ450	04-06	YA-4504	YA-4504PK	63-1123	RX-4990DR	KN-141	
449	YFZ450	04-06	YA-4504	YA-4504PK	63-1123	RX-4990DY	KN-141	
449	YFZ450	04-06	YA-4504	YA-4504PK	YA-4504-T	YA-4504-TDK	KN-141	
449	YFZ450	07-08	YA-4504	YA-4504PK	63-1123	RX-4990DK	KN-140	
449	YFZ450	07-08	YA-4504	YA-4504PK	63-1123	RX-4990DL	KN-140	

2) Requires Two; 3) Requires Three; 4) Requires Four. The use of custom air filter requires removal of air box. Some custom filters and intakes are not legal for sale or use on any pollution controlled motor vehicle in California or states adopting California emission procedures. See knfilters.com for CARB status on each part for a specific vehicle.



ATV - Application Listing

CC	Model	Year	Air Filter	Air Filter Precharger	Custom	Custom Precharger	Oil Filter	Comments
YAMAHA								
449	YFZ450	07-08	YA-4504	YA-4504PK	63-1123	RX-4990DR	KN-140	
449	YFZ450	07-08	YA-4504	YA-4504PK	63-1123	RX-4990DY	KN-140	
449	YFZ450	07-09	YA-4504	YA-4504PK	YA-4504-T	YA-4504-TDK	KN-140	
449	YFZ450	09	YA-4504	YA-4504PK	63-1123*	RX-4990DK	KN-140	*Exc. F/I
449	YFZ450	09	YA-4504	YA-4504PK	63-1123*	RX-4990DL	KN-140	*Exc. F/I
449	YFZ450	09	YA-4504	YA-4504PK	63-1123*	RX-4990DR	KN-140	*Exc. F/I
449	YFZ450	09	YA-4504	YA-4504PK	63-1123*	RX-4990DY	KN-140	*Exc. F/I
449	YFZ450	12-13	YA-4504	YA-4504PK	YA-4504-T	YA-4504-TDK	KN-140	
449	YFZ450 Bill Ballance Edition	06	YA-4504	YA-4504PK	63-1123	RX-4990DK	KN-141	
449	YFZ450 Bill Ballance Edition	06	YA-4504	YA-4504PK	63-1123	RX-4990DL	KN-141	
449	YFZ450 Bill Ballance Edition	06	YA-4504	YA-4504PK	63-1123	RX-4990DR	KN-141	
449	YFZ450 Bill Ballance Edition	06	YA-4504	YA-4504PK	63-1123	RX-4990DY	KN-141	
449	YFZ450 Bill Ballance Edition	06	YA-4504	YA-4504PK	YA-4504-T	YA-4504-TDK	KN-141	
449	YFZ450 SE	07-08	YA-4504	YA-4504PK	63-1123	RX-4990DK	KN-140	
449	YFZ450 SE	07-08	YA-4504	YA-4504PK	63-1123	RX-4990DL	KN-140	
449	YFZ450 SE	07-08	YA-4504	YA-4504PK	63-1123	RX-4990DR	KN-140	
449	YFZ450 SE	07-08	YA-4504	YA-4504PK	63-1123	RX-4990DY	KN-140	
449	YFZ450 SE	07-08	YA-4504	YA-4504PK	YA-4504-T	YA-4504-TDK	KN-140	
449	YFZ450R	09-16	YA-4504	YA-4504PK			KN-140	
449	YFZ450R	17	YA-4504	YA-4504PK				
449	YFZ450R SE	11-16	YA-4504	YA-4504PK			KN-140	
449	YFZ450R SE	17	YA-4504	YA-4504PK				
449	YFZ450X Bill Ballance	09	YA-4504	YA-4504PK			KN-140	
449	YZF 450R SE	15					KN-140	
450	YFM450 Grizzly	13	YA-3504	YA-3504PK			KN-204*	*Chrome=KN-204C
450	YFM450 Grizzly Auto	12-14	YA-3504	YA-3504PK			KN-204*	*Chrome=KN-204C
450	YFM450 Grizzly Auto 4x4	07-09	YA-3504	YA-3504PK			KN-204*	*Chrome=KN-204C
450	YFM450 Grizzly Auto 4x4	11	YA-3504	YA-3504PK			KN-204*	*Chrome=KN-204C
450	YFM450 Grizzly Auto 4x4 Hunter	09	YA-3504	YA-3504PK			KN-204*	*Chrome=KN-204C
450	YFM450 Grizzly Auto 4x4 IRS	09-10	YA-3504	YA-3504PK			KN-204*	*Chrome=KN-204C
450	YFM450 Grizzly Auto EPS	11-12	YA-3504	YA-3504PK			KN-204*	*Chrome=KN-204C
450	YFM450 Grizzly EPS	13-14	YA-3504	YA-3504PK			KN-204*	*Chrome=KN-204C
450	YFM450 Grizzly EPS Hunter	13-14	YA-3504	YA-3504PK			KN-204*	*Chrome=KN-204C
450	YFM450 Grizzly Hunter	13	YA-3504	YA-3504PK			KN-204*	*Chrome=KN-204C
450	YFM450FX Wolverine 4x4	06	YA-3504	YA-3504PK			KN-303*	*Chrome=KN-303C
450	YFM450FX Wolverine 4x4	07-08	YA-3504	YA-3504PK			KN-204*	*Chrome=KN-204C
450	YFM450FX Wolverine Auto 4x4	09-11	YA-3504	YA-3504PK			KN-204*	*Chrome=KN-204C
450	YXR450 Rhino Auto 4x4	06	YA-6504	YA-6504PK			KN-303*	*Chrome=KN-303C
450	YXR450 Rhino Auto 4x4	07-09	YA-6504	YA-6504PK			KN-204*	*Chrome=KN-204C
450	YXR450 Rhino Auto 4x4 Special Ed.	07-08	YA-6504	YA-6504PK			KN-204*	*Chrome=KN-204C
489	YFM450 Kodiak Auto 4x4	03	YA-4003	KA-3603PK			KN-303*	*Chrome=KN-303C
550	YFM550F Grizzly FI Auto 4x4 EPS	12	YA-7007				KN-204*	*Chrome=KN-204C
558	YFM550F Grizzly FI Auto 4x4	09-14	YA-7007				KN-204*	*Chrome=KN-204C
558	YFM550F Grizzly FI Auto 4x4 EPS	09-11	YA-7007				KN-204*	*Chrome=KN-204C
558	YFM550F Grizzly FI Auto 4x4 EPS	13-14	YA-7007				KN-204*	*Chrome=KN-204C
600	YFM600 Grizzly	98-01	YA-4350	YA-4350PK			KN-145	
660	YFM660 Grizzly	02-03	YA-6602	YA-4350PK			KN-303*	*Chrome=KN-303C
660	YFM660 Grizzly Auto 4x4	04-06	YA-6602	YA-4350PK			KN-303*	*Chrome=KN-303C
660	YFM660 Grizzly Auto 4x4	07-08	YA-6602	YA-4350PK			KN-204*	*Chrome=KN-204C
660	YFM660R Raptor	01-05	YA-6601	25-6601	YA-6601-T	YA-6601-TDK	KN-147	
660	YFM660R Raptor	01-05	YA-6601	YA-6601DK	YA-6601-T	YA-6601-TDK	KN-147	
660	YXR660 Rhino	04-06	YA-6504	YA-6504PK	63-1119	62-1300DK	KN-303*	*Chrome=KN-303C
660	YXR660 Rhino	04-06	YA-6504	YA-6504PK	63-1119	RX-3810DK	KN-303*	*Chrome=KN-303C
660	YXR660 Rhino	04-06	YA-6504	YA-6504PK	63-1119	RX-3810DR	KN-303*	*Chrome=KN-303C
660	YXR660 Rhino	04-06	YA-6504	YA-6504PK	RK-3920*	22-8012PK	KN-303**	*Clutch Filter Kit/ **Chrome=KN-303C

2) Requires Two; 3) Requires Three; 4) Requires Four. The use of custom air filter requires removal of air box. Some custom filters and intakes are not legal for sale or use on any pollution controlled motor vehicle in California or states adopting California emission procedures. See knfilters.com for CARB status on each part for a specific vehicle.

ATV - Application Listing



CC	Model	Year	Air Filter	Air Filter Precharger	Custom	Custom Precharger	Oil Filter	Comments
YAMAHA								
660	YXR660 Rhino	04-06	YA-6504	YA-6504PK	RK-3920*	RB-0900DK	KN-303**	*Clutch Filter Kit/ **Chrome=KN-303C
660	YXR660 Rhino	07	YA-6504	YA-6504PK	63-1119	62-1300DK	KN-204*	*Chrome=KN-204C
660	YXR660 Rhino	07	YA-6504	YA-6504PK	63-1119	RX-3810DK	KN-204*	*Chrome=KN-204C
660	YXR660 Rhino	07	YA-6504	YA-6504PK	63-1119	RX-3810DR	KN-204*	*Chrome=KN-204C
660	YXR660 Rhino	07	YA-6504	YA-6504PK	RK-3920*	22-8012PK	KN-204**	*Clutch Filter Kit/ **Chrome=KN-204C
660	YXR660 Rhino	07	YA-6504	YA-6504PK	RK-3920*	RB-0900DK	KN-204**	*Clutch Filter Kit/ **Chrome=KN-204C
686	YFM700F Grizzly FI Auto 4x4	07-15	YA-7007				KN-204*	*Chrome=KN-204C
686	YFM700F Grizzly FI Auto 4x4 EPS	07-15	YA-7007				KN-204*	*Chrome=KN-204C
686	YFM700F Grizzly FI Auto 4x4 EPS SE	09-15	YA-7007				KN-204*	*Chrome=KN-204C
686	YXM700 Viking FI 4x4	14-15					KN-204*	*Chrome=KN-204C
686	YXM700 Viking FI 4x4 EPS	14-15					KN-204*	*Chrome=KN-204C
686	YXM700 Viking FI 4x4 EPS SE	14-17					KN-204*	*Chrome=KN-204C
686	YXM700 Viking FI 4x4 EPS w/Suntop	14-17					KN-204*	*Chrome=KN-204C
686	YXM700 Viking FI 4x4 w/Suntop	14-17					KN-204*	*Chrome=KN-204C
686	YXM700 Viking VI	15-17					KN-204*	*Chrome=KN-204C
686	YXM700 Viking VI EPS	15-17					KN-204*	*Chrome=KN-204C
686	YXM700 Viking VI EPS Ranch Edition	16-17					KN-204*	*Chrome=KN-204C
686	YXM700 Viking VI EPS SE	15-17					KN-204*	*Chrome=KN-204C
686	YXR700 Rhino FI	08-11	YA-7008	YA-7008DK	63-1121	22-8049DK	KN-204*	*Chrome=KN-204C
686	YXR700 Rhino FI Auto 4x4 Special Ed.	08	YA-7008	YA-7008DK	63-1121	22-8049DK	KN-204*	*Chrome=KN-204C
686	YXR700 Rhino FI Auto 4x4 Sport Ed.	08	YA-7008	YA-7008DK	63-1121	22-8049DK	KN-204*	*Chrome=KN-204C
686	YXR700 Rhino FI Auto 4x4 Sport Ed.	11	YA-7008	YA-7008DK	63-1121	22-8049DK	KN-204*	*Chrome=KN-204C
700	YFM700 Raptor	13-17	YA-7006	25-1770			KN-145	
700	YFM700 Raptor	13-17	YA-7006	RU-0520PK			KN-145	
700	YFM700R Raptor	06-09	YA-7006	25-1770			KN-145	
700	YFM700R Raptor	06-09	YA-7006	RU-0520PK			KN-145	
700	YFM700R Raptor	11-17	YA-7006	25-1770			KN-145	
700	YFM700R Raptor	11-17	YA-7006	RU-0520PK			KN-145	
700	YFM700R Raptor GYTR Edition	07	YA-7006	25-1770			KN-145	
700	YFM700R Raptor GYTR Edition	07	YA-7006	RU-0520PK			KN-145	
700	YFM700R Raptor SE	07-17	YA-7006	25-1770			KN-145	
700	YFM700R Raptor SE	07-17	YA-7006	RU-0520PK			KN-145	
700	YXR700 Rhino FI	12-13	YA-7008	YA-7008DK	63-1121	22-8049DK	KN-204*	*Chrome=KN-204C
700	YXR700 Rhino FI Auto 4x4 Special Ed.	13	YA-7008	YA-7008DK	63-1121	22-8049DK	KN-204*	*Chrome=KN-204C
700	YXR700 Rhino FI Auto 4x4 Sport Ed.	13	YA-7008	YA-7008DK	63-1121	22-8049DK	KN-204*	*Chrome=KN-204C
708	Kodiak 700	16					KN-147	
708	YFM700 Grizzly EPS LE	17	YA-7016				KN-147	
708	YFM700F Grizzly FI Auto 4x4	16	YA-7016				KN-147	
708	YFM700F Grizzly FI Auto 4x4 EPS	17	YA-7016				KN-147	
708	YFM700F Grizzly FI Auto 4x4 EPS SE	17	YA-7016				KN-147	
708	YFM700K Kodiak	16-17	YA-7016				KN-147	
708	YFM700K Kodiak EPS	16-17	YA-7016				KN-147	
708	YFM700K Kodiak EPS SE	16-17	YA-7016				KN-147	
708	YXE70 Wolverine	16-17					KN-204*	*Chrome=KN-204C
708	YXE70 Wolverine EPS	17					KN-204*	*Chrome=KN-204C
708	YXE70 Wolverine R-Spec	16-17					KN-204*	*Chrome=KN-204C
708	YXE70 Wolverine R-Spec EPS	16-17					KN-204*	*Chrome=KN-204C
708	YXE70 Wolverine R-Spec EPS SE	16-17					KN-204*	*Chrome=KN-204C
998	YXZ1000R	16	YA-0116				KN-204*	*Chrome=KN-204C
998	YXZ1000R	17	YA-0116					
998	YXZ1000R SE	16	YA-0116				KN-204*	*Chrome=KN-204C
998	YXZ1000R SE	17	YA-0116					
998	YXZ1000R SS	17	YA-0116					

2) Requires Two; 3) Requires Three; 4) Requires Four. The use of custom air filter requires removal of air box. Some custom filters and intakes are not legal for sale or use on any pollution controlled motor vehicle in California or states adopting California emission procedures. See knfilters.com for CARB status on each part for a specific vehicle.

FILTER FACTS

HOW TO SELECT THE IDEAL AIR FILTER

If maximum horsepower is the objective, the selection of the correct filter is of paramount importance. Two factors dictate the ability of the air filter unit to flow the maximum amount of air into the engine, these being the shape and size. With a K&N® air filter, we can take the outside dimensions of the air filter as a means of selecting sufficient area for the air flow required.

Let us deal with shape first. K&N's air flow bench has shown that with typical two and four barrel automotive carburetors, air flow is greater when the diameter of the air filter is large in comparison to its height. This means that an air filter that is 10" in diameter and 2" high, will generally flow more air than an air filter which is 5" in diameter and 4" high. If space permits, you should choose an air filter where the height of the air filter is between 1/5 and 1/4 of the air filter's diameter. Another thing that the air flow bench has shown, is that there are exceptions to every rule. One such exception occurs when an air filter is clamped on a long runner used to feed a throttle body on an electronic fuel injected engine. The straighter the air can enter the tube, the lower the restriction will be. Hence, in order to let the air travel as straight as possible, a filter that has a height of 2 to 4 times its diameter will work best. On single throat carburetors or injector stacks where one air filter per throat is used, a taller air filter can also be used to an advantage. The diameter of the air filter in relation to the throat of the carburetor is important and generally the diameter of the air filter should be at least three times the diameter of the throat of the carburetor. When space does not permit the ideal filter shape, choose a size that will still allow enough airflow for the engine.

Once you have determined the shape of the filter required, the size of the filter must be selected. This is important. A filter that is too small can literally strangle an engine, in addition, if too small of a filter is used, the filtering efficiency drops dramatically due to the excessive speed of the incoming air actually opening up the passages in the cotton gauze. At K&N, we believe a pressure drop of 1.5" of water across the air filter element at maximum power RPM, is the most that should be used for sizing a new air filter.

Two factors dictate filter size: displacement of the engine in cubic centimeters (cc), and the RPM turned at maximum horsepower. The effective area of a filter is the diameter in inches x 3.1416 x the height of the air filter in inches, less .75". The reason we subtract the .75" is because of the rubber seals on the end of the filter, and the fact that very little air flows near them, so this part of the filter is not included.

To determine the minimum size of filter that is required for your application, apply the following formula (table 1):

Let us assume that we will put one filter for each carburetor for a total of 4 filters. The flange of the carburetors should be measured so that the proper size clamp-on filter can be found. In this case each carburetor has a 2 1/16" O.D. flange. The maximum diameter of each air filter should be determined next. The measurement between the centerline of each carburetor will be the maximum diameter possible. Any frame, tubes, or other obstructions may further reduce the diameter possible. For ease of carburetor calibration, always use 4 filters of the same size. So if the measurements are 3.4", 3.7", 3.4", but there is a frame tube that will interfere on the outer carburetors at 1.5", the maximum diameter that all 4 filters can be, is 3.0", because of the frame interference. (table 2).

Now the filter element height can be calculated from the formula (table 3):

Referencing the specialty air filter section will show a couple of choices that will be acceptable for this application. We can use an RU-1880 which is 3" O.D. x 2 1/2" long with a rubber top. RC-1880 has the same dimensions but with a chrome top. And finally there is RC-1890 which has a length of 3" and a chrome top. This would be the best choice if the longer length will fit on the bike, because the service interval will be lengthened.

2) Engine: 1100cc 4 cylinder, 4 stroke motorcycle engine installed in an off-road dune buggy. The redline of the engine is 10,000 RPM (table 4):

In this situation, it would be better to use a single air filter, remotely mounted so that it may be changed easily if necessary. This will require custom fabrication of some tubing duct-work to hook up to the carburetors and allow a single large clamp-on filter to be installed. Let's say we will use 4" O.D. tubing to connect our filter to the carburetors. This will require a filter with a 4" flange. We will use 6" as our O.D. (table 5):

For off-road conditions, the filter should be 1.5 to 2 times the minimum, to allow more surface area for the dirt to build up on. Therefore the filter required will be 3.21-4.28 inches tall. Checking the specialty air filter section, we come up with RE-0870, which is a tapered clamp-on, 6" O.D. on the base and 4 5/8" O.D. on the top, with a filter length of 9" (in off-road air filters, bigger is better).

For a vehicle of any other sort, an air filter element about the size dictated by the formula will probably do the job. The formula will usually give an odd size for an answer. You should always select a larger size. The larger the air filter, the longer you can go before servicing is required.

CONCLUSIONS

K&N air filters are designed to provide high air flow while at the same time providing the protection needed to ensure long engine life. A walk through the pits at an off-road race will show the numerous K&N filters installed on competitive and class-winning machines. A look at these same filters after the race will show a considerable amount of dirt on the outside of the filter, yet the inside will be as clean as a new filter (provided the filter was serviced and the case was sealed properly), and that's the way it should be. Whether you are racing to win or just driving to work, you can't afford to be without a K&N High-Flow Air Filter™!

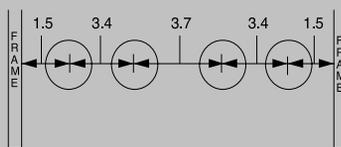

Table 2

$$H = \frac{A / \# \text{ of filters}}{D \times 3.14} + .75$$

Plugging in the numbers, we have:

$$H = \frac{15.8 / 4}{3 \times 3.14} + .75 = 1.16''$$

Table 3

$$A = \frac{1100 \times 10,000}{85,381 \times 4} = 32.2 \text{ sq. in.}$$

Table 4

$$H = \frac{26.3 / 1}{2.14''} + .75 = 6 \times 3.14$$

Table 5

$$A = \frac{\text{cc} \times \text{RPM}}{85,381 \times \text{stroke type}}$$

A = effective filtering area
cc = cubic centimeter displacement
RPM = redline of engine
Stroke type = 2 or 4

To find the total height (including the rubber sealing edges) of the filter needed, apply this formula:

$$H = \frac{A / \# \text{ of filters}}{D \times 3.14} + .75$$

D = estimated maximum diameter that will fit unobstructed in the vehicle.
H = height of filter

To make things clear, study these two examples:

1) Engine: 600cc 4-cylinder, 4-stroke, with 4 carburetors and a redline of 11,000 rpm, in a street bike.

$$A = \frac{\text{cc} \times \text{RPM}}{85,381 \times \text{stroke type}}$$

Applying the formula for filter area, we have:

$$A = \frac{600 \times 11,000}{85,381 \times 4} = 15.8 \text{ sq. inches}$$

Table 1

Round Straight

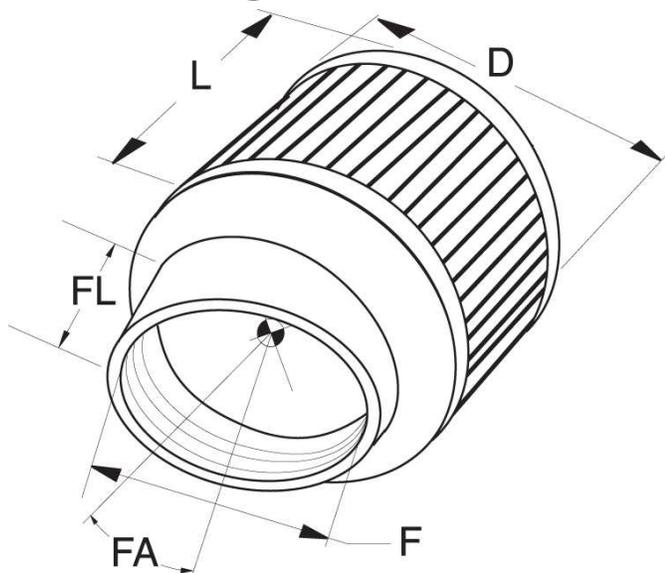

When selecting one of K&N's universal round straight air filters, you should consider the following dimensions as they relate to the specification chart:

(F) Mounting Flange Inside Diameter - This is the most critical dimension and should be very close to the diameter of the application's inlet flange. The flange will stretch up to 1/16" for those in-between sizes.

(D) Filter Diameter - This is the overall diameter of the filter. Always use the largest diameter practical for maximum filtration.

(L) Filter Length - This dimension is the length of the filter body only, it does not include the flange length. Always use the longest filter practical for maximum filtration.

(FA/FL) Flange Angle and/or Length - If no angle is listed in the specifications table, then the flange is straight. Any angle listed is in degrees and can be utilized when space is a problem.

(FO) Flange Offset - In some cases the center of the flange is offset from the center of the filter base in order to provide a better fit.

(F) Mounting Flange Inside Diameter		(D) Filter Diameter		(L) Filter Length		(FL) Flange Length		(FA) Flange Style		(FO) Flange Offset		Rubber End Cap Part #	Chrome End Cap Part #	Custom End Cap Part #	Filter Wraps Part #
Inch	mm	Inch	mm	Inch	mm	Inch	mm	Type	Angle	Inch	mm				
														RE-5287	
5/16	8	1-3/8	35	1-1/8	29	7/16	11	Centered						62-2470	
3/8	10	2	51	1-1/2	38	3/8	10	Centered						62-1570 ²⁸	
		2	51	1-1/2	38	7/16	11	Centered					62-1320		
		2	51	1-3/4	44	1/2	13	Centered					62-1600WT-		
		2	51	1-3/4	44	5	127	Centered					62-1600RD-		
1/2	13	2	51	1-1/2	38	7/16	11	Centered					62-1330		
11/20	14	1-3/8	35	1-1/8	29	219/500	11	Centered					62-2480		
9/16	14	2	51	2-1/8	54	1	25	Centered					62-1230		
5/8	16	1-3/8	35	1-1/8	29	3/8	10	Centered				RU-3230			
		2	51	1-1/2	38	7/16	11	Centered					62-1340		
3/4	19	1-3/8	35	1-1/8	29	7/16	11	Centered				62-1560			
		2	51	1-1/2	38	7/16	11	Centered						62-1360	
		2	51	2-1/2	64	5/8	16	Centered				RU-3630			
1	25	2	51	1-1/2	38	5/8	16	Centered					62-1370		
		3	76	2-1/4	57	5/8	16	Centered					62-1420		RU-0150PK
		3	76	2-3/8	60	7/16	11	Centered			62-1410				RU-0150PK
1-1/16	27	3	76	3	76	5/8	16	Centered			R-1040				22-8008PK
1-1/4	32	3	76	2-1/2	64	5/8	16	Centered			62-1380				RU-0150PK
		3	76	2-1/2	64	5/8	16	Centered					62-1580		
		3	76	2-1/2	64	7/8	22	Centered					62-1390		RU-0150PK
		3	76	3	76	5/8	16	Centered			RU-0060				22-8008PK
		3	76	4	102	5/8	16	Centered			RU-0070				22-8009PK
		3	76	4	102	3/4	19	Angled	20°		RU-0100				22-8009PK
		3	76	5	127	5/8	16	Centered			RU-0080				RU-0210PK
		3	76	5	127	3/4	19	Angled	20°		RU-0110				RU-0210PK

1) 1/4-20 Jack Nut Into Top 2) Base Has (2) 7/8" Vents 3) Base Has 1/2" Vent 4) Base Has 1/32" Vent 5) Base Has 1/4" Vent 6) Base Has 11/16" Vent 7) Base Has 1-1/8" Vent 8) Base Has 13/16" Vent 9) Base Has 13/32" Vent 10) Base Has 13/64" Vent 11) Base Has 2-3/16" Square Inlet 12) Base Has 15/64" Vent 13) Base Has 19/32" Vent 14) Base Has 21/32" Vent 15) Base Has 25/64" Vent 16) Base Has 29/32" Vent 17) Base Has 3/16" Vent 18) Base Has 3/4" Vent 19) Base Has 3/8" Vent 20) Base Has 31/64" Vent 21) Base Has 35/64" Vent 22) Base Has 45/64" Vent 23) Base Has 5/16" Vent 24) Base Has 5/8" Vent 25) Base Has 55/64" Vent 26) Base Has 7/16" Vent 27) Base Has 7/8" Vent 28) Base Has 9/16" Vent 29) Base Has Opt. 1/2" Vent 30) Base Has 23/32" Vent 31) Base Has 25/32" Vent 32) Filter Has Molded-in Velocity Stack 33) Filter Is Reverse Tapered 34) Fits Legend/Dwarf Race Cars w/FJ1200 Motors 35) Base Has 15/32" Vent 36) Top Plate Has 1/4-20 Stud 37) Top-Plate Has 6MM Stud 39) Offset Is Vertical 41) Offset Is Vertical And To The Right 42) Top Has 1/2" Vent 43) Top Has 1-1/16" Center Hole 44) Top Has 21/32" Center Hole 45) Top Has 23/32" Center Hole 46) Top Has 5/32" Center Hole 47) Top Has 7/16" Center Hole 48) Base Has 11/32" Vent 49) Top Has 1/4" Center Hole 50) Top Has 1-7/16" Center Hole 51) 2-1/2" Adapter Included 52) Top Has 5/8" Vent 53) Tapered Insert Included 5" to 4-3/8" 54) Filter Has Thru Hole 2-3/4" x 1-5/8"

Round Straight



(F) Mounting Flange Inside Diameter		(D) Filter Diameter		(L) Filter Length		(FL) Flange Length		(FA) Flange Style		(FO) Flange Offset		Rubber End Cap Part #	Chrome End Cap Part #	Custom End Cap Part #	Filter Wraps Part #	
Inch	mm	Inch	mm	Inch	mm	Inch	mm	Type	Angle	Inch	mm					
1-3/8	35	3	76	2-1/2	64	7/16	11	Centered					62-1440		RU-0150PK	
		3	76	2-1/2	64	5/8	16	Centered				62-1430			RU-0150PK	
1-1/2	38	3	76	2-1/2	64	7/16	11	Centered					62-1460		RU-0150PK	
		3	76	2-1/2	64	5/8	16	Centered				62-1450		RU-0150PK		
		3	76	3	76	5/8	16	Centered				RU-0155				
		3	76	4	102	5/8	16	Centered				RU-0160			22-8009PK	
		3	76	6	152	5/8	16	Centered				RU-0175				
1-9/16	40	3	76	2	51	5/8	16	Centered					RC-0840		RU-0150PK	
		3	76	2-1/4	57	5/8	16	Centered					RC-0880		RU-0150PK	
		3	76	2-1/2	64	5/8	16	Centered				RU-2310	RC-0160		RU-0150PK	
		3	76	3	76	5/8	16	Centered					RC-0870		22-8008PK	
		3-1/2	89	1-1/2	38	5/8	16	Centered					RC-0170		RC-0170DK	
1-11/16	43	3	76	2-1/2	64	5/8	16	Centered				RU-1130	RC-1130		RU-0150PK	
		3	76	3	76	5/8	16	Centered					RC-1120		22-8008PK	
		3	76	4	102	5/8	16	Centered				RU-0200			22-8009PK	
		3	76	5	127	5/8	16	Centered				RU-0210			RU-0210PK	
		3	76	6	152	1-1/2	38	Angled	40°			R-1030			22-8010PK	
		3-1/2	89	2	51	5/8	16	Centered					RC-0190			
		3-1/2	89	10	254	5/8	16	Centered				RU-3850			25-3918	
		4	102	2	51	5/8	16	Centered				RU-0260				
		5-1/4	133	2	51	5/8	16	Offset		3/4	19	RU-0310				
		1-3/4	44	3	76	2	51	5/8	16	Centered				RU-2570		
3	76			2-1/2	64	5/8	16	Centered				62-1470		62-1480	RU-0150PK	
3	76			3	76	5/8	16	Centered				RU-2685				
3	76			6	152	5/8	16	Centered				RU-2575				
3-1/2	89			1-1/2	38	5/8	16	Centered					RC-2870		RC-0170DK	
3-1/2	89			4	102	5/8	16	Centered				KA-2712				
3-1/2	89			4-1/2	114	1	25	Angled	10°			RU-1030			RU-0510PK	
3-1/2	89			5	127	5/8	16	Centered				RU-0360			25-1770	
3-1/2	89			5	127	3/4	19	Angled	10°			RU-1040			25-1770	
3-1/2	89			6	152	5/8	16	Centered				R-1050			25-1770	
3-1/2	89			6	152	3/4	19	Angled	10°			RU-1050			RU-0520PK	
4-1/2	114			1-1/2	38	5/8	16	Offset		9/16	14			RC-0330		25-0330
4-1/2	114			1-1/2	38	5/8	16	Centered				RU-0340	RC-0340			25-0330
4-1/2	114	2	51	5/8	16	Centered				RU-0370	RC-0370					
1-13/16	46	3	76	2-1/4	57	5/8	16	Centered					RC-0910		RU-0150PK	
		3	76	2-1/4	57	1	25	Centered					RC-2620		RU-0150PK	
		3	76	3	76	5/8	16	Centered					RC-0890		22-8008PK	
		5-1/2	140	3	76	5/8	16	Offset		15/16	24	RU-0350			22-8015PK	
1-7/8	48	3	76	1-1/2	38	5/8	16	Centered				RU-2560				
		3	76	2	51	5/8	16	Centered				RU-3350			RU-0150PK	
		3	76	4	102	5/8	16	Centered				RU-0400			22-8009PK	
		3	76	4	102	1	25	Angled	10°			RU-1280	RC-1280		22-8009PK	
		3	76	5	127	5/8	16	Centered				RU-0410	RC-0410		RU-0210PK	
		3	76	6	152	5/8	16	Centered				RU-0420			22-8010PK	

1) 1/4-20 Jack Nut Into Top 2) Base Has (2) 7/8" Vents 3) Base Has 1/2" Vent 4) Base Has 1/32" Vent 5) Base Has 1/4" Vent 6) Base Has 11/16" Vent 7) Base Has 1-1/8" Vent 8) Base Has 13/16" Vent 9) Base Has 13/32" Vent 10) Base Has 13/64" Vent 11) Base Has 2-3/16" Square Inlet 12) Base Has 15/64" Vent 13) Base Has 19/32" Vent 14) Base Has 21/32" Vent 15) Base Has 25/64" Vent 16) Base Has 29/32" Vent 17) Base Has 3/16" Vent 18) Base Has 3/4" Vent 19) Base Has 3/8" Vent 20) Base Has 31/64" Vent 21) Base Has 35/64" Vent 22) Base Has 45/64" Vent 23) Base Has 5/16" Vent 24) Base Has 5/8" Vent 25) Base Has 55/64" Vent 26) Base Has 7/16" Vent 27) Base Has 7/8" Vent 28) Base Has 9/16" Vent 29) Base Has Opt. 1/2" Vent 30) Base Has 23/32" Vent 31) Base Has 25/32" Vent 32) Filter Has Molded-in Velocity Stack 33) Filter Is Reverse Tapered 34) Fits Legend/Dwarf Race Cars w/FJ1200 Motors 35) Base Has 15/32" Vent 36) Top Plate Has 1/4-20 Stud 37) Top Plate Has 6MM Stud 38) Offset Is Vertical 39) Offset Is Vertical And To The Right 40) Top Has 1/2" Vent 41) Top Has 1-1/16" Center Hole 42) Top Has 21/32" Center Hole 43) Top Has 23/32" Center Hole 44) Top Has 5/32" Center Hole 45) Top Has 5/32" Center Hole 46) Top Has 7/16" Center Hole 47) Top Has 11/32" Vent 48) Base Has 11/32" Vent 49) Top Has 1/4" Center Hole 50) Top Has 1-7/16" Center Hole 51) 2-1/2" Adapter Included 52) Top Has 5/8" Vent 53) Tapered Insert Included 5" to 4-3/8" 54) Filter Has Thru Hole 2-3/4" x 1-5/8"



Round Straight

(F) Mounting Flange Inside Diameter		(D) Filter Diameter		(L) Filter Length		(FL) Flange Length		(FA) Flange Style		(FO) Flange Offset		Rubber End Cap Part #	Chrome End Cap Part #	Custom End Cap Part #	Filter Wraps Part #
Inch	mm	Inch	mm	Inch	mm	Inch	mm	Type	Angle	Inch	mm				
1-7/8	48	3-1/2	89	4	102	5/8	16	Centered				RD-0450			RU-0500PK
		3-1/2	89	5	127	5/8	16	Centered				RD-0460			25-1770
		3-1/2	89	6	152	5/8	16	Centered				RD-0470			25-1770
1-15/16	49	3	76	2	51	5/8	16	Centered				RU-2700			RU-0150PK
		3	76	2-1/2	64	5/8	16	Centered				RU-2760			RU-0150PK
		3	76	3	76	5/8	16	Centered				RP-5164			22-8008PK
		3	76	4	102	5/8	16	Centered				RP-5119			22-8009PK
		3-1/2	89	4	102	2	51	Angled	20°			RU-1400			RU-0500PK
		3-1/2	89	5	127	2	51	Angled	20°			RU-1410			25-1770
		3-1/2	89	6	152	2	51	Angled	20°			RU-1420			25-1770
2	51	5-1/8	130	2	51	11/16	17	Offset		1	25		RC-2400		
		5-3/8	137	2	51	5/8	16	Centered					RC-2440		
		7	178	9	229	5/8	16	Centered					41-1000 ²		22-8022PK
2-1/16	52	3	76	2-1/2	64	5/8	16	Centered				RU-1880	RC-1880		RU-0150PK
		3	76	3	76	5/8	16	Centered					RC-1890		22-8008PK
		3-1/2	89	3	76	5/8	16	Centered					RC-1150		
		3-1/2	89	4	102	5/8	16	Centered				RU-0500	RC-0500		RU-0500PK
		3-1/2	89	4	102	7/8	22	Centered				RA-0500			RU-0500PK
		3-1/2	89	5	127	5/8	16	Centered				RU-0510			25-1770
		3-1/2	89	5	127	3/4	19	Angled	10°			RU-1060			25-1770
		3-1/2	89	5	127	7/8	22	Centered				RA-0510			25-1770
		3-1/2	89	5	127	2-1/2	64	Angled	17°			RU-1780			25-1770
		3-1/2	89	6	152	5/8	16	Centered				RU-0520			25-1770
		3-1/2	89	6	152	3/4	19	Angled	10°			RU-1070			25-1770
		3-1/2	89	6	152	7/8	22	Centered				RA-0520			25-1770
		4-1/2	114	4	102	7/8	22	Centered				RA-0530			22-8012PK
		4-1/2	114	5	127	7/8	22	Centered				RA-0540			22-8013PK
		5-1/2	140	2	51	5/8	16	Offset			5/16	8	RU-0570		
5-1/2	140	2	51	7/8	22	Centered					RA-0550 ⁵	RA-055V ⁵			
5-1/2	140	3	76	7/8	22	Centered					RA-0560 ⁵	RA-056V ⁵		22-8015PK	
5-1/2	140	4	102	7/8	22	Centered					RA-0570 ⁵	RA-057V ⁵			
5-1/2	140	5	127	7/8	22	Centered					RA-0580 ⁵	RA-058V ⁵		22-8016PK	
5-7/8	149	2	51	7/8	22	Offset			1-1/8	29	RA-0450 ⁵	RA-045V ⁵		22-8017PK	
5-7/8	149	3	76	7/8	22	Offset			1-1/8	29	RA-0460 ⁵	RA-046V ⁵		22-8018PK	
5-7/8	149	4	102	7/8	22	Offset			1-1/8	29	RA-0470 ⁵	RA-047V ⁵			
2-1/8	54	3	76	3	76	5/8	16	Centered					RC-1910		22-8008PK
		3-1/2	89	4	102	7/8	22	Centered				RD-0500			RU-0500PK
		3-1/2	89	4	102	1	25	Angled	5°			RB-0500			RU-0500PK
		3-1/2	89	5	127	7/8	22	Centered				RD-0510			25-1770
		3-1/2	89	5	127	1	25	Angled	5°			RB-0510	RC-0510		RA-0510DB
		3-1/2	89	6	152	7/8	22	Centered				RD-0520			25-1770
3-1/2	89	6	152	1	25	Angled	5°			RB-0520			25-1770		
2-5/32	55	3-9/16	90	5-9/16	141	7/16	11	Centered						DU-8015	
2-1/4	57	3-1/2	89	1-1/4	32	5/8	16	Centered					RC-2880		RC-0170DK
		3-1/2	89	2	51	5/8	16	Centered					RC-1900		

1) 1/4-20 Jack Nut Into Top 2) Base Has (2) 7/8" Vents 3) Base Has 1/2" Vent 4) Base Has 1/32" Vent 5) Base Has 1/4" Vent 6) Base Has 11/16" Vent 7) Base Has 1-1/8" Vent 8) Base Has 13/16" Vent 9) Base Has 13/32" Vent 10) Base Has 13/64" Vent 11) Base Has 2-3/16" Square Inlet 12) Base Has 15/64" Vent 13) Base Has 19/32" Vent 14) Base Has 21/32" Vent 15) Base Has 25/64" Vent 16) Base Has 29/32" Vent 17) Base Has 3/16" Vent 18) Base Has 3/4" Vent 19) Base Has 3/8" Vent 20) Base Has 31/64" Vent 21) Base Has 35/64" Vent 22) Base Has 45/64" Vent 23) Base Has 5/16" Vent 24) Base Has 5/8" Vent 25) Base Has 55/64" Vent 26) Base Has 7/16" Vent 27) Base Has 7/8" Vent 28) Base Has 9/16" Vent 29) Base Has Opt. 1/2" Vent 30) Base Has 23/32" Vent 31) Base Has 25/32" Vent 32) Filter Has Molded-in Velocity Stack 33) Filter Is Reverse Tapered 34) Fits Legend/Dwarf Race Cars w/FJ1200 Motors 35) Base Has 15/32" Vent 36) Top Plate Has 1/4-20 Stud 37) Top-Plate Has 6MM Stud 38) Offset Is Vertical 39) Offset Is Vertical And To The Right 40) Top Has 1/2" Vent 41) Top Has 1-1/16" Center Hole 42) Top Has 21/32" Center Hole 43) Top Has 23/32" Center Hole 44) Top Has 5/32" Center Hole 45) Top Has 7/16" Center Hole 46) Top Has 11/32" Vent 47) Top Has 11/32" Vent 48) Base Has 11/32" Vent 49) Top Has 1/4" Center Hole 50) Top Has 1-7/16" Center Hole 51) 2-1/2" Adapter Included 52) Top Has 5/8" Vent 53) Tapered Insert Included 5" to 4-3/8" 54) Filter Has Thru Hole 2-3/4" x 1-5/8"



(F) Mounting Flange Inside Diameter		(D) Filter Diameter		(L) Filter Length		(FL) Flange Length		(FA) Flange Style		(FO) Flange Offset		Rubber End Cap Part #	Chrome End Cap Part #	Custom End Cap Part #	Filter Wraps Part #
Inch	mm	Inch	mm	Inch	mm	Inch	mm	Type	Angle	Inch	mm				
2-1/4	57	3-1/2	89	4	102	5/8	16	Centered				RU-0600			RU-0500PK
		3-1/2	89	4	102	1	25	Angled	5°			RB-0600			RU-0500PK
		3-1/2	89	4	102	1	25	Angled	20°			RU-1700			RU-0500PK
		3-1/2	89	5	127	5/8	16	Centered				RU-0610			25-1770
		3-1/2	89	5	127	3/4	19	Angled	10°			RU-1080			25-1770
		3-1/2	89	5	127	1	25	Angled	5°			RB-0610			25-1770
		3-1/2	89	5	127	1	25	Angled	20°			RU-1710			25-1770
		3-1/2	89	6	152	5/8	16	Centered				RU-0620			25-1770
		3-1/2	89	6	152	3/4	19	Angled	10°			RU-1090			25-1770
		3-1/2	89	6	152	1	25	Angled	5°			RB-0620			25-1770
		3-1/2	89	6	152	1	25	Angled	20°			RU-1720			25-1770
		3-1/2	89	10	254	5/8	16	Centered				RU-3840			25-3918
		4-1/2	114	2	51	5/8	16	Offset		5/16	8		RC-1950		
		4-1/2	114	4	102	5/8	16	Centered				RU-0630			22-8012PK
		4-1/2	114	5	127	5/8	16	Centered				RU-0640			22-8013PK
		5-1/2	140	2-1/2	64	5/8	16	Offset		13/16	21	RU-0650	RC-0650		
		5-1/2	140	3	76	5/8	16	Offset		13/16	21	RU-0660			22-8015PK
		5-1/2	140	3-1/2	89	5/8	16	Centered				RU-0690			
		5-1/2	140	5	127	5/8	16	Offset		13/16	21	RU-0680			22-8016PK
		7	178	9	229	5/8	16	Centered					41-1100 ²		22-8022PK
2-3/8	60	4-7/16	113	6-1/16	154	3/4	19	Centered				CM-8012			
2-7/16	62	3-1/2	89	4	102	5/8	16	Centered				RU-0800			RU-0500PK
		3-1/2	89	5	127	5/8	16	Centered				RU-0810			25-1770
		3-1/2	89	6	152	5/8	16	Centered				RU-0820 ⁴			25-1770
		3-1/2	89	6	152	1-1/8	29	Centered				RU-3030			25-1770
		3-3/4	95	2	51	2	51	Angled	20°			RU-1730			
		3-3/4	95	4	102	2	51	Angled	20°			RU-1750			22-8011PK
		3-3/4	95	5	127	2	51	Angled	20°			RU-1760			RU-1460PK
		3-3/4	95	6	152	2	51	Angled	20°			RU-1770			RU-1470PK
		4	102	4-3/4	121	3/4	19	Centered						RX-4040-1 ^{1,15}	
		4-1/2	114	4	102	5/8	16	Centered				RU-0830			22-8012PK
		4-1/2	114	5	127	5/8	16	Centered				RU-0840			22-8013PK
		5-1/8	130	2	51	5/8	16	Centered					RC-0850		
		5-1/8	130	3	76	5/8	16	Centered					RC-0860		22-8015PK
		5-1/2	140	3	76	5/8	16	Offset		1/2	13	RU-0870			22-8015PK
		5-1/2	140	4	102	5/8	16	Offset		1/2	13	RU-0880			
		5-1/2	140	6	152	5/8	16	Offset		1/2	13	RU-1000			22-8045DK
2-1/2	64	3-1/2	89	4	102	5/8	16	Centered				RD-0700			RU-0500PK
		3-1/2	89	4	102	1	25	Angled	5°			RB-0700			RU-0500PK
		3-1/2	89	5	127	5/8	16	Centered				RD-0710			25-1770
		3-1/2	89	5	127	1	25	Angled	5°			RB-0710			25-1770
		3-1/2	89	6	152	5/8	16	Centered				RD-0720			25-1770
		3-1/2	89	6	152	1	25	Angled	5°			RB-0720			25-1770
		5-9/16	141	6	152	3/4	19	Centered				PL-3214			PL-3214DK
		7	178	9	229	5/8	16	Centered					41-1200 ²		22-8022PK

1) 1/4-20 Jack Nut Into Top 2) Base Has (2) 7/8" Vents 3) Base Has 1/2" Vent 4) Base Has 1/32" Vent 5) Base Has 1/4" Vent 6) Base Has 11/16" Vent 7) Base Has 1-1/8" Vent 8) Base Has 13/16" Vent 9) Base Has 13/32" Vent 10) Base Has 13/64" Vent 11) Base Has 2-3/16" Square Inlet 12) Base Has 15/64" Vent 13) Base Has 19/32" Vent 14) Base Has 21/32" Vent 15) Base Has 25/64" Vent 16) Base Has 29/32" Vent 17) Base Has 3/16" Vent 18) Base Has 3/4" Vent 19) Base Has 3/8" Vent 20) Base Has 31/64" Vent 21) Base Has 35/64" Vent 22) Base Has 45/64" Vent 23) Base Has 5/16" Vent 24) Base Has 5/8" Vent 25) Base Has 55/64" Vent 26) Base Has 7/16" Vent 27) Base Has 7/8" Vent 28) Base Has 9/16" Vent 29) Base Has Opt. 1/2" Vent 30) Base Has 23/32" Vent 31) Base Has 25/32" Vent 32) Filter Has Molded-in Velocity Stack 33) Filter Is Reverse Tapered 34) Fits Legend/Dwarf Race Cars w/F1200 Motors 35) Base Has 15/32" Vent 36) Top Plate Has 1/4-20 Stud 37) Top Plate Has 6MM Stud 38) Offset Is Vertical 39) Offset Is Vertical And To The Right 40) Top Has 1/2" Vent 41) Top Has 1-1/16" Center Hole 42) Top Has 21/32" Center Hole 43) Top Has 5/32" Center Hole 44) Top Has 5/32" Center Hole 45) Top Has 5/32" Center Hole 46) Top Has 5/32" Center Hole 47) Top Has 7/16" Center Hole 48) Base Has 11/32" Vent 49) Top Has 1/4" Center Hole 50) Top Has 1-7/16" Center Hole 51) 2-1/2" Adapter Included 52) Top Has 5/8" Vent 53) Tapered Insert Included 5" to 4-3/8" 54) Filter Has Thru Hole 2-3/4" x 1-5/8"



Round Straight

(F) Mounting Flange Inside Diameter		(D) Filter Diameter		(L) Filter Length		(FL) Flange Length		(FA) Flange Style		(FO) Flange Offset		Rubber End Cap Part #	Chrome End Cap Part #	Custom End Cap Part #	Filter Wraps Part #	
Inch	mm	Inch	mm	Inch	mm	Inch	mm	Type	Angle	Inch	mm					
2-9/16	65	4-1/2	114	4	102	3/4	19	Centered				RA-0600			22-8012PK	
		4-1/2	114	5	127	3/4	19	Centered				RA-0610			22-8013PK	
		5-1/2	140	2	51	3/4	19	Centered				RA-0620 ⁵	RA-062V ⁵			
		5-1/2	140	3	76	3/4	19	Centered				RA-0630 ⁵	RA-063V ⁵		22-8015PK	
		5-1/2	140	4	102	3/4	19	Centered				RA-0640 ⁵				
		5-1/2	140	5	127	3/4	19	Centered				RA-0650 ⁵			22-8016PK	
		5-7/8	149	3	76	7/8	22	Offset			13/16	21		RA-067V ⁵		
		5-7/8	149	4	102	7/8	22	Offset			13/16	21	RA-0680 ⁵			
		6	152	2	51	7/8	22	Offset			13/16	21	RA-0660 ⁵	RA-066V ⁵		22-8017PK
		6	152	3	76	7/8	22	Offset			13/16	21	RA-0670 ⁵			
6	152	4	102	7/8	22	Offset			13/16	21		RA-068V ⁵				
2-5/8	67	4	102	4	102	1	25	Angled	5°			RB-0800			22-8011PK	
		4	102	5	127	1	25	Angled	5°			RB-0810			25-1770	
		4-1/2	114	2	51	5/8	16	Centered				RU-2630				
		4-1/2	114	3	76	5/8	16	Centered				RU-2640				
		4-1/2	114	4	102	5/8	16	Centered				RU-2650			22-8012PK	
2-11/16	68	4-1/16	103	7	178	3/4	19	Centered				RX-5032				
		4-1/2	114	4	102	5/8	16	Centered				RU-0900			22-8012PK	
		4-1/2	114	5	127	5/8	16	Centered				RU-0910			22-8013PK	
2-3/4	70	4	102	5	127	1	25	Angled	10°			RU-1460			RU-1460PK	
		4	102	6	152	1	25	Angled	10°			RU-1470			25-1770	
		4	102	6	152	2	51	Angled	20°			RU-3190			25-1770	
		4	102	7	178	1	25	Angled	10°			RU-1480			RU-1480PK	
		5-1/8	130	2	51	5/8	16	Centered					RC-0920			
		5-1/8	130	3	76	5/8	16	Centered					RC-0930		22-8015PK	
		5-1/2	140	3	76	5/8	16	Offset			7/16	11	RU-0940			22-8015PK
		5-1/2	140	4	102	5/8	16	Offset			7/16	11	RU-0950			
		5-1/2	140	5	127	5/8	16	Offset			7/16	11	RU-0960			22-8016PK
		7	178	3	76	5/8	16	Offset			11/16	17	RU-0980			RU-0980PK
7	178	7	178	5/8	16	Offset			11/16	17	RU-2940			25-3900		
2-7/8	73	4	102	5-3/8	137	5/8	16	Centered				RU-2410			25-3900	
		4	102	6	152	5/8	16	Centered				RU-1620			25-1770	
		4-1/2	114	5	127	5/8	16	Centered				RU-3710	RC-3710		HA-3094PR	
		4-1/2	114	6-1/8	156	5/8	16	Centered				E-1989			RX-3820PK	
		4-7/8	124	7-1/4	184	11/16	17	Centered				E-1988				
2-29/32	74	4-15/16	125	5-29/32	150	11/16	17	Centered				RC-9070				
3	76	4-5/16	110	4	102	1	25	Angled	5°			RB-0900			22-8012PK	
		4-5/16	110	5	127	1	25	Angled	5°			RB-0910			22-8013PK	
		5	127	3	76	5/8	16	Centered				RU-2420			22-8015PK	
		5	127	5	127	5/8	16	Centered				RU-2430		RC-5182XD	RU-2430PK	
		5	127	6-1/2	165	5/8	16	Centered				RU-2820			22-8044PK	
		5	127	7	178	5/8	16	Centered						RX-2820 ¹⁵	22-8044PK	
		5	127	9	229	5/8	16	Centered					RC-2530 ^{2,33}		25-3918	
		7	178	2	51	5/8	16	Offset			7/8	22	RA-0970 ⁴	RA-097V ⁴		
7	178	3	76	5/8	16	Offset			7/8	22	RA-0980 ⁴	RA-098V ⁴		RU-0980PK		

1) 1/4-20 Jack Nut Into Top 2) Base Has (2) 7/8" Vents 3) Base Has 1/2" Vent 4) Base Has 1/32" Vent 5) Base Has 1/4" Vent 6) Base Has 11/16" Vent 7) Base Has 1-1/8" Vent 8) Base Has 13/16" Vent 9) Base Has 13/32" Vent 10) Base Has 13/64" Vent 11) Base Has 2-3/16" Square Inlet 12) Base Has 15/64" Vent 13) Base Has 19/32" Vent 14) Base Has 21/32" Vent 15) Base Has 25/64" Vent 16) Base Has 29/32" Vent 17) Base Has 3/16" Vent 18) Base Has 3/4" Vent 19) Base Has 3/8" Vent 20) Base Has 31/64" Vent 21) Base Has 35/64" Vent 22) Base Has 45/64" Vent 23) Base Has 5/16" Vent 24) Base Has 5/8" Vent 25) Base Has 55/64" Vent 26) Base Has 7/16" Vent 27) Base Has 7/8" Vent 28) Base Has 9/16" Vent 29) Base Has Opt. 1/2" Vent 30) Base Has 23/32" Vent 31) Base Has 25/32" Vent 32) Filter Has Molded-in Velocity Stack 33) Filter Is Reverse Tapered 34) Fits Legend/Dwarf Race Cars w/FJ1200 Motors 35) Base Has 15/32" Vent 36) Top Plate Has 1/4-20 Stud 37) Top Plate Has 6MM Stud 39) Offset Is Vertical 41) Offset Is Vertical And To The Right 42) Top Has 1/2" Vent 43) Top Has 1-1/16" Center Hole 44) Top Has 21/32" Center Hole 45) Top Has 23/32" Center Hole 46) Top Has 5/32" Center Hole 47) Top Has 7/16" Center Hole 48) Base Has 11/32" Vent 49) Top Has 1/4" Center Hole 50) Top Has 1-7/16" Center Hole 51) 2-1/2" Adapter Included 52) Top Has 5/8" Vent 53) Tapered Insert Included 5" to 4-3/8" 54) Filter Has Thru Hole 2-3/4" x 1-5/8"



(F) Mounting Flange Inside Diameter		(D) Filter Diameter		(L) Filter Length		(FL) Flange Length		(FA) Flange Style		(FO) Flange Offset		Rubber End Cap Part #	Chrome End Cap Part #	Custom End Cap Part #	Filter Wraps Part #
Inch	mm	Inch	mm	Inch	mm	Inch	mm	Type	Angle	Inch	mm				
3	76	7	178	3	76	1-1/8	29	Offset		1-1/16	27		RC-3140		RU-0980PK
		7	178	4	102	5/8	16	Offset		7/8	22	RA-0990 ⁴	RA-099V ⁴		22-8019PK
		7	178	6	152	1	25	Centered					RD-1300		22-8021PK
3-1/16	78	6-7/8	175	5-15/16	151	9/16	14	Centered				RU-9040			
		7	178	3	76	5/8	16	Centered				RA-0950 ⁴	RA-095V ⁴		RU-0980PK
		7	178	4	102	5/8	16	Centered				RA-0960 ⁴	RA-096V ⁴		22-8019PK
		7	178	6	152	5/8	16	Centered				RU-9004			22-8021PK
3-1/8	79	5	127	1-7/8	48	3/4	19	Offset		1	25	YA-6598			
		6	152	4-1/4	108	5/8	16	Centered					E-2996		
3-5/16	84	5-3/8	137	6-3/16	157	5/8	16	Centered				E-1998			
		5-13/16	148	7-1/4	184	3/4	19	Centered					E-0774		
3-3/8	86	4-7/8	124	12-1/4	311	0	0	Centered				CM-9715			
		5-13/16	148	7-1/4	184	5/8	16	Centered					E-1009		
3-1/2	89	4-1/2	114	2-1/4	57									RE-5286	RE-5286DK
		5	127	3	76	5/8	16	Centered				RU-1790	RC-1790		22-8015PK
		5	127	5-5/8	143	5/8	16	Centered				RU-5114			CM-4508DK
		5	127	8-1/2	216	5/8	16	Centered				RU-1785			
3-17/32	90	4	102	5-31/32	152	23/32	18	Centered						RX-4140 ¹⁵	RU-1470PK
3-5/8	92	5-13/16	148	7-1/4	184	3/4	19	Centered				E-0773			
4	102	6-1/4	159	6	152	13/16	21	Centered				E-1996			
		6-1/4	159	7-3/4	197	13/16	21	Centered					E-2999		
		7	178	6	152	5/8	16	Centered					RD-1400 ⁵¹		22-8020PK
		7	178	6	152	1	25	Centered				RD-1450			22-8021PK
		7	178	8	203	5/8	16	Centered					RD-1410		
		7	178	9	229	1	25	Centered				RD-1460			22-8022PK
		7	178	18	457	5/8	16	Centered					41-1400 ²		25-3918
5	127	6-1/2	165	9	229	1	25	Centered				RU-3020			22-8022PK
		6-1/2	165	10	254	1	25	Centered				RU-3220			22-8022PK
5-1/2	140	7	178	9	229	1	25	Centered				RC-3150 ²		22-8022PK	
6	152	7-1/2	191	4-1/2	114	1	25	Centered				RU-1850			
		7-1/2	191	6	152	1	25	Centered				RU-3060			25-3900
		7-1/2	191	8	203	1	25	Centered				RU-3260			
		7-1/2	191	10	254	1	25	Centered				RU-3270			RU-3270DR
		7-1/2	191	12	305	1	25	Centered				RU-3040			25-3918

1) 1/4-20 Jack Nut Into Top 2) Base Has (2) 7/8" Vents 3) Base Has 1/2" Vent 4) Base Has 1/32" Vent 5) Base Has 1/4" Vent 6) Base Has 11/16" Vent 7) Base Has 1-1/8" Vent 8) Base Has 13/16" Vent 9) Base Has 13/32" Vent 10) Base Has 13/64" Vent 11) Base Has 2-3/16" Square Inlet 12) Base Has 15/64" Vent 13) Base Has 19/32" Vent 14) Base Has 21/32" Vent 15) Base Has 25/64" Vent 16) Base Has 29/32" Vent 17) Base Has 3/16" Vent 18) Base Has 3/4" Vent 19) Base Has 3/8" Vent 20) Base Has 31/64" Vent 21) Base Has 35/64" Vent 22) Base Has 45/64" Vent 23) Base Has 5/16" Vent 24) Base Has 5/8" Vent 25) Base Has 55/64" Vent 26) Base Has 7/16" Vent 27) Base Has 7/8" Vent 28) Base Has 9/16" Vent 29) Base Has Opt. 1/2" Vent 30) Base Has 23/32" Vent 31) Base Has 25/32" Vent 32) Filter Has Molded-in Velocity Stack 33) Filter Is Reverse Tapered 34) Fits Legend/Dwarf Race Cars w/FJ1200 Motors 35) Base Has 15/32" Vent 36) Top Plate Has 1/4-20 Stud 37) Top-Plate Has 6MM Stud 39) Offset Is Vertical 41) Offset Is Vertical And To The Right 42) Top Has 1/2" Vent 43) Top Has 1-1/16" Center Hole 44) Top Has 21/32" Center Hole 45) Top Has 23/32" Center Hole 46) Top Has 5/32" Center Hole 47) Top Has 7/16" Center Hole 48) Base Has 11/32" Vent 49) Top Has 1/4" Center Hole 50) Top Has 1-7/16" Center Hole 51) 2-1/2" Adapter Included 52) Top Has 5/8" Vent 53) Tapered Insert Included 5" to 4-3/8" 54) Filter has Thru Hole 2-3/4" x 1-5/8"

Round Tapered

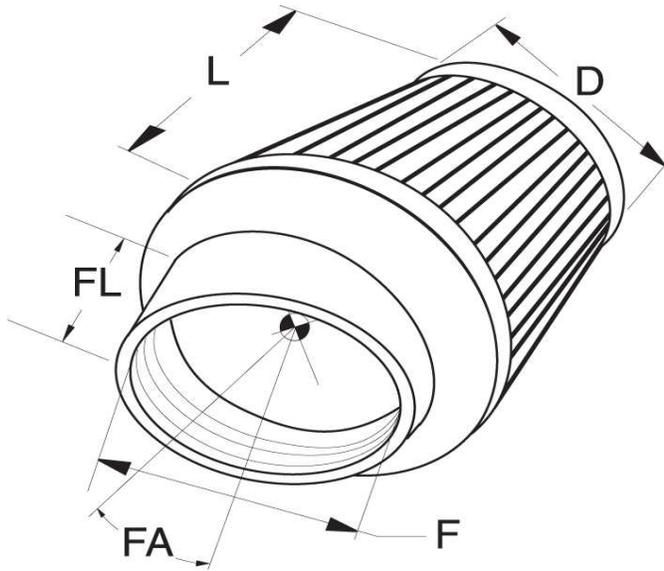

When selecting one of K&N's universal round tapered air filters, you should consider the following dimensions as they relate to the specification chart:

(F) Mounting Flange Inside Diameter - This is the most critical dimension and should be very close to the diameter of the application's inlet flange. The flange will stretch up to 1/16" for those in-between sizes.

(D) Filter Diameter - This is the outside diameter of the filter. Always use the largest diameter practical for maximum filtration.

(L) Filter Length - This dimension is the length of the filter body only, it does not include the flange length. Always use the longest filter practical for maximum filtration.

(FA/FL) Flange Angle and/or Length - If no angle is listed in the specifications table, then the flange is straight. Any angle listed is in degrees and can be utilized when space is a problem.

(FO) Flange Offset - In some cases the center of the flange is offset from the center of the filter base in order to provide a better fit.

(F) Mounting Flange Inside Diameter		(D) Filter Base Diameter		(D) Filter Top Diameter		(L) Filter Length		(FL) Flange Length		(FA) Flange Style	(FO) Flange Offset	Rubber End Cap Part #	Chrome End Cap Part #	Custom End Cap Part #	Filter Wraps Part #	
Inch	mm	Inch	mm	Inch	mm	Inch	mm	Inch	mm	Type	Angle	Inch	mm			
5/16	8	1-3/8	35	1	25	1	25	5/8	16	Centered		RU-3490				
		1-3/8	35	1	25	1-3/8	35	3/8	10	Centered		RU-3170				
1	25	2-7/8	73	3-1/2	89	3-1/2	89	5/8	16	Centered		RE-0200 ²⁰				
1-1/8	29	2-1/4	57	2	51	2-1/2	64	5/8	16	Centered			RC-2540			RC-2540PK
1-1/4	32	2-7/8	73	3-1/2	89	3-1/2	89	5/8	16	Centered		RE-0220 ²⁰				
		2-15/16	75	3-1/2	89	2-7/16	62	5/8	16	Centered		RE-0230 ²⁰				
1-3/8	35	2-1/2	64	2	51	2-1/4	57	5/8	16	Centered			RC-0790			RC-0790PK
1-1/2	38	3	76	3-1/2	89	3-1/2	89	5/8	16	Centered		RE-0240 ²⁰				
1-9/16	40	2-5/8	67	2	51	3	76	5/8	16	Centered			RC-2290			22-8028PK
		3	76	2	51	3	76	5/8	16	Centered			RC-2310			22-8028PK
1-11/16	43	3	76	2	51	2-3/8	60	5/8	16	Centered			RC-2490			
		3	76	2	51	2-3/4	70	5/8	16	Centered		R-1070	RC-1070			22-8028PK
		3	76	2	51	4	102	1-1/2	38	Angled	40°	R-1100				22-8048PK
		3-1/2	89	2	51	4	102	5/8	16	Centered		R-1080				22-8029PK
1-3/4	44	3	76	2	51	2-1/2	64	5/8	16	Centered		RU-2690				
		3	76	3-1/2	89	3-1/2	89	5/8	16	Centered		RE-0260 ¹				
		4-3/8	111	3	76	2-1/2	64	5/8	16	Centered		RU-2680				
		4-1/2	114	3	76	2-1/2	64	5/8	16	Offset		9/16 14	RU-2740			
1-13/16	46	3	76	2	51	2-1/2	64	5/8	16	Centered		RU-2930				22-8028PK
		3	76	2	51	3	76	5/8	16	Centered		RU-2320	RC-2320			22-8028PK
1-7/8	48	3	76	2	51	2	51	5/8	16	Centered		RU-2550	RC-2550			
		3	76	2	51	3	76	5/8	16	Centered		R-1090	RC-1090			22-8028PK
		3	76	2	51	3-11/16	94	1	25	Angled	10°		RC-1290			22-8048PK
1-15/16	49	3	76	2	51	2-1/2	64	5/8	16	Centered		RU-2660	RC-2500			22-8028PK
		3	76	2	51	3	76	5/8	16	Centered		R-1060	RC-1060			22-8028PK

1) 1/4-20 Jack Nut Into Top 2) Base Has (2) 7/8" Vents 3) Base Has 1/2" Vent 4) Base Has 1/32" Vent 5) Base Has 1/4" Vent 6) Base Has 11/16" Vent 7) Base Has 1-1/8" Vent 8) Base Has 13/16" Vent 9) Base Has 13/32" Vent 10) Base Has 13/64" Vent 11) Base Has 2-3/16" Square Inlet 12) Base Has 15/64" Vent 13) Base Has 19/32" Vent 14) Base Has 21/32" Vent 15) Base Has 25/64" Vent 16) Base Has 29/32" Vent 17) Base Has 3/16" Vent 18) Base Has 3/4" Vent 19) Base Has 3/8" Vent 20) Base Has 31/64" Vent 21) Base Has 35/64" Vent 22) Base Has 45/64" Vent 23) Base Has 5/16" Vent 24) Base Has 5/8" Vent 25) Base Has 55/64" Vent 26) Base Has 7/16" Vent 27) Base Has 7/8" Vent 28) Base Has 9/16" Vent 29) Base Has Opt. 1/2" Vent 30) Base Has 23/32" Vent 31) Base Has 25/32" Vent 32) Filter Has Molded-in Velocity Stack 33) Filter Is Reverse Tapered 34) Fits Legend/Dwarf Race Cars w/FJ1200 Motors 35) Base Has 15/32" Vent 36) Top Plate Has 1/4-20 Stud 37) Top Plate Has 6MM Stud 39) Offset Is Vertical 41) Offset Is Vertical And To The Right 42) Top Has 1/2" Vent 43) Top Has 1-1/16" Center Hole 44) Top Has 21/32" Center Hole 45) Top Has 23/32" Center Hole 46) Top Has 5/32" Center Hole 47) Top Has 7/16" Center Hole 48) Base Has 11/32" Vent 49) Top Has 1/4" Center Hole 50) Top Has 1-7/16" Center Hole 51) 2-1/2" Adapter Included 52) Top Has 5/8" Vent 53) Tapered Insert Included 5" to 4-3/8" 54) Filter Has Thru Hole 2-3/4" x 1-5/8"

(F) Mounting Flange Inside Diameter		(D) Filter Base Diameter		(D) Filter Top Diameter		(L) Filter Length		(FL) Flange Length		(FA) Flange Style		(FO) Flange Offset		Rubber End Cap Part #	Chrome End Cap Part #	Custom End Cap Part #	Filter Wraps Part #	
Inch	mm	Inch	mm	Inch	mm	Inch	mm	Inch	mm	Type	Angle	Inch	mm					
2	51	3	76	3-1/2	89	3-1/2	89	5/8	16	Centered				RE-0280 ²⁰				
		3-1/8	79	2	51	3	76	5/8	16	Centered				RU-2580	RC-2580		22-8028PK	
		5-3/16	132	3-1/2	89	3-7/16	87	1-3/8	35	Offset			21/32	17			RC-8350 ³⁷	
		5-3/16	132	3-1/2	89	3-11/16	94	1-3/8	35	Offset			21/32	17			RC-9920 ^{34,15}	
		6-7/8	175	5-7/8	149	2-9/16	65	1-3/4	44	Offset			7/8	22			RC-70018 ^{3,19,5}	
2-1/16	52	3-1/4	83	3	76	4	102	5/8	16	Centered						RC-1350		
		3-1/2	89	2	51	4	102	5/8	16	Centered				RU-1200	RC-1200		22-8029PK	
		3-1/2	89	3	76	4	102	7/8	22	Centered					RA-050V			
		3-9/16	90	3-1/2	89	4-7/8	124	5/8	16	Centered					RC-8170			
2-1/8	54	3	76	2	51	2-3/4	70	5/8	16	Centered						RC-2340	22-8028PK	
		3	76	2	51	3	76	5/8	16	Centered					RC-2330	22-8028PK		
		3-1/2	89	2	51	4	102	5/8	16	Centered					RC-1920	22-8029PK		
		4-1/2	114	3-1/2	89	4-3/4	121	13/16	21	Centered					RC-4890			
		5-3/16	132	3-1/2	89	5-1/2	140	7/8	22	Offset			19/32	15			RC-8090 ⁴⁴	
2-3/16	56	6-13/16	173	5-7/8	149	2-9/16	65	1-3/4	44	Offset		27/32	21			RC-5154 ³		
2-1/4	57	3-1/2	89	2	51	4	102	5/8	16	Centered				R-1260	RC-1250		22-8029PK	
		5	127	3-1/2	89	3-9/16	90	11/16	17	Centered					RC-9220 ¹¹			
		5-1/8	130	4-5/8	117	6	152	5/8	16	Centered				RU-3560			25-3900	
		6-13/16	173	5-7/8	149	2-9/16	65	1-3/4	44	Centered					RC-70021 ²⁸			
2-9/32	58	4-17/32	115	3-1/2	89	4-15/16	125	2-13/32	61	Centered					RC-5157			
2-3/8	60	4-5/8	117	3-1/2	89	4-13/16	122	13/16	21	Centered						RC-9380		
		5-3/16	132	3-1/2	89	3-3/4	95	23/32	18	Offset			17/32	13			RC-1624	
		5-3/16	132	3-1/2	89	4-3/16	106	5/8	16	Offset			19/32	15			RC-9830 ⁶	
		5-3/16	132	3-1/2	89	4-11/32	110	3/4	19	Offset			19/32	15			RC-8490 ¹⁸	
		5-3/16	132	3-1/2	89	4-5/16	110	3/4	19	Offset			21/32	17			RC-9390	
2-13/32	61	4-23/32	120	3-31/32	101	5-63/100	143	3-11/32	85	Centered						RX-5179		
2-7/16	62	3-1/2	89	2	51	5	127	5/8	16	Centered				SN-2570			SN-2570PK	
		3-3/4	95	3	76	4	102	2	51	Angled	20°				SN-2530		SN-2530PK	
		3-3/4	95	3	76	5	127	2	51	Angled	20°				SN-2520		SN-2520PK	
		3-3/4	95	3	76	6	152	2	51	Angled	20°				SN-2510		SN-2510PK	
		4-7/16	113	4	102	3-3/4	95	7/8	22	Centered						RX-4010		
		4-1/2	114	4	102	6-1/8	156	7/8	22	Centered						RX-3820-1 ^{1,15}	RX-3820PK	
		4-1/2	114	4	102	6-9/16	167	2-15/16	75	Angled	20°					RX-3800 ¹⁵	RX-3820PK	
		4-1/2	114	6	152	6-1/8	156	7/8	22	Centered						RX-3810XD ^{1,15}	RX-3810DK	
		4-1/2	114	6	152	6-9/16	167	2-7/8	73	Angled	20°					RX-3770 ^{1,15}	RX-3810DK	
		5-1/8	130	3-1/2	89	6	152	5/8	16	Centered						RC-4160	RC-4160DK	
5-1/2	140	4-1/2	114	4	102	5/8	16	Offset			1/2	13	R-1380					
2-1/2	64	4-1/2	114	3-1/2	89	3-3/16	81	3/4	19	Centered						RC-8100		
		4-1/2	114	3-1/2	89	5	127	3/4	19	Centered						RC-9630	RC-9350DK	
		4-1/2	114	3-1/2	89	6	152	3/4	19	Centered						RC-5062XD	RC-5062DK	
		4-21/32	118	3-1/2	89	3-7/8	98	13/16	21	Centered						RC-9080		
		4-21/32	118	3-1/2	89	4-7/8	124	13/16	21	Centered						RC-9800		
		4-21/32	118	3-1/2	89	5-15/16	151	13/16	21	Centered						RC-9360		
5	127	5-1/2	140	2-3/4	70	5/8	16	Centered							RE-0380			

1) 1/4-20 Jack Nut Into Top 2) Base Has (2) 7/8" Vents 3) Base Has 1/2" Vent 4) Base Has 1/32" Vent 5) Base Has 1/4" Vent 6) Base Has 11/16" Vent 7) Base Has 1-1/8" Vent 8) Base Has 13/16" Vent 9) Base Has 13/32" Vent 10) Base Has 13/64" Vent 11) Base Has 2-3/16" Square Inlet 12) Base Has 15/64" Vent 13) Base Has 19/32" Vent 14) Base Has 21/32" Vent 15) Base Has 25/64" Vent 16) Base Has 29/32" Vent 17) Base Has 3/16" Vent 18) Base Has 3/4" Vent 19) Base Has 3/8" Vent 20) Base Has 31/64" Vent 21) Base Has 35/64" Vent 22) Base Has 45/64" Vent 23) Base Has 5/16" Vent 24) Base Has 5/8" Vent 25) Base Has 55/64" Vent 26) Base Has 7/16" Vent 27) Base Has 7/8" Vent 28) Base Has 9/16" Vent 29) Base Has Opt. 1/2" Vent 30) Base Has 23/32" Vent 31) Base Has 25/32" Vent 32) Filter Has Molded-in Velocity Stack 33) Filter Is Reverse Tapered 34) Fits Legend/Dwarf Race Cars w/FJ1200 Motors 35) Base Has 15/32" Vent 36) Top Plate Has 1/4-20 Stud 37) Top-Plate Has 6MM Stud 39) Offset Is Vertical 41) Offset Is Vertical And To The Right 42) Top Has 1/2" Vent 43) Top Has 1-1/16" Center Hole 44) Top Has 21/32" Center Hole 45) Top Has 23/32" Center Hole 46) Top Has 5/32" Center Hole 47) Top Has 7/16" Center Hole 48) Base Has 11/32" Vent 49) Top Has 1/4" Center Hole 50) Top Has 1-7/16" Center Hole 51) 2-1/2" Adapter Included 52) Top Has 5/8" Vent 53) Tapered Insert Included 5" to 4-3/8" 54) Filter Has Thru Hole 2-3/4" x 1-5/8"



Round Tapered

(F) Mounting Flange Inside Diameter		(D) Filter Base Diameter		(D) Filter Top Diameter		(L) Filter Length		(FL) Flange Length		(FA) Flange Style		(FO) Flange Offset		Rubber End Cap Part #	Chrome End Cap Part #	Custom End Cap Part #	Filter Wraps Part #	
Inch	mm	Inch	mm	Inch	mm	Inch	mm	Inch	mm	Type	Angle	Inch	mm					
2-1/2	64	5-3/16	132	3-1/2	89	3-3/4	95	11/16	17	Offset		19/32	15		RC-9700			
		5-3/16	132	3-1/2	89	4-9/16	116	3/4	19	Offset		11/16	17		RC-9780			
		5-3/16	132	3-1/2	89	4-9/16	116	3/4	19	Offset		19/32	15		RC-9490	RC-8320 ³⁷		
		5-3/16	132	3-1/2	89	4-11/16	119	3/4	19	Offset		19/32	15		RC-9690 ²¹			
		5-3/16	132	3-1/2	89	5-15/16	151	3/4	19	Offset		19/32	15		RC-9510 ²¹			
		5-1/4	133	2-1/2	64	5-3/4	146	1-1/2	38	Angled	20°				RU-5006			
		5-1/4	133	2-1/2	64	5-3/4	146	1-1/2	38	Centered					RU-5005			
		5-1/4	133	3-1/2	89	4-1/2	114	11/16	17	Offset		5/8	16		RC-9420 ⁶			
		5-1/4	133	5-1/2	140	1-7/8	48	5/8	16	Centered						ML-0850		
		5-3/8	137	5-1/2	140	5-7/8	149	3/4	19	Centered					E-1006			
5-1/2	140	4-1/2	114	6	152	3/4	19	Centered					RC-4670		RF-1023DK			
6	152	5	127	5	127	2	51	Centered					RU-5174		RX-4990DK			
6	152	5	127	5-1/2	140	2	51	Centered					RU-4950		RX-4950 ¹	RX-4990DK		
6	152	5	127	6-1/2	165	2	51	Centered					RU-4860		RX-4860 ¹	RX-4730DK		
6-11/16	170	3-1/2	89	7-1/16	179	13/16	21	Offset		1	25		RC-9300 ^{31,3}					
6-27/32	174	5-27/32	148	2-9/16	65	1-25/32	45	Angled	30°				RC-5049					
2-9/16	65	6-7/8	175	5-7/8	149	2-1/2	64	1-11/16	43	Offset		7/8	22		RC-4620 ⁴			
2-5/8	67	5-3/16	132	3-1/2	89	4-1/2	114	3/4	19	Offset		21/32	17		RC-9250			
		5-3/16	132	3-1/2	89	6	152	3/4	19	Offset		1-1/2	38		RC-9340			
2-11/16	68	4-7/16	113	3-1/2	89	4-7/16	113	5/8	16	Centered					RC-9280			
		4-1/2	114	3	76	5	127	5/8	16	Centered					RC-4340		SN-2520PK	
		5-3/16	132	3-1/2	89	4-5/16	110	3/4	19	Offset		9/16	14		RC-8070 ²³			
		5-3/16	132	3-1/2	89	4-3/8	111	3/4	19	Offset		9/16	14		RC-9400 ^{22,24}			
		5-3/16	132	3-1/2	89	4-7/16	113	3/4	19	Offset		9/16	14		RC-9650			
		5-3/16	132	3-1/2	89	4-1/2	114	3/4	19	Offset		9/16	14		RC-9580 ²⁵			
		5-3/16	132	3-1/2	89	4-9/16	116	3/4	19	Offset		9/16	14		RC-9440 ²¹			
		5-3/16	132	3-1/2	89	4-9/16	116	5/8	16	Offset		19/32	15		RC-9560			
		5-3/16	132	3-1/2	89	6	152	3/4	19	Offset		19/32	15		RC-9680 ¹⁷			
		5-3/16	132	3-1/2	89	6	152	3/4	19	Offset		9/16	14		RC-9590 ¹⁷			
5-3/16	132	4	102	3-7/16	87	3/4	19	Offset		19/32	15		RU-9160					
5-3/4	146	3-1/2	89	4-1/2	114	3/4	19	Offset		1/2	13		RC-9940 ^{8,30}					
5-3/4	146	3-1/2	89	6-5/8	168	3/4	19	Offset		1-1/2	38		RC-1586 ²⁶					
5-25/32	147	3-1/2	89	4-9/16	116	5/8	16	Offset		1/2	13		RC-9730 ^{35,37}					
2-23/32	69	6-11/16	170	3-1/2	89	7-23/32	196	5/8	16	Offset		1	25		RC-9290			
2-3/4	70	3-3/4	95	4	102	5-9/16	141	13/16	21	Centered				RU-5090			RC-9310DK	
		4	102	2	51	6	152	1	25	Angled	10°			RU-3120			22-8030DK	
		4	102	2	51	7	178	1	25	Angled	10°			RU-3590				
		4	102	3	76	5	127	1	25	Angled	10°			SN-2590			SN-2590PK	
		4	102	3	76	6	152	1	25	Angled	10°			SN-2600			SN-2600PK	
		4	102	3	76	6	152	2	51	Angled	20°			SN-2620			SN-2620PK	
		4-1/2	114	3	76	4	102	5/8	16	Centered					SN-2580			SN-2580PK
		4-11/16	119	3-1/2	89	4-1/16	103	3/4	19	Centered					RC-9870			
		4-11/16	119	3-1/2	89	4-7/8	124	13/16	21	Centered					RC-9350			RC-9350DK
		4-11/16	119	3-1/2	89	5-5/16	135	13/16	21	Centered					RC-8340			
4-11/16	119	3-1/2	89	6	152	3/4	19	Centered					RC-5159					

1) 1/4-20 Jack Nut Into Top 2) Base Has (2) 7/8" Vents 3) Base Has 1/2" Vent 4) Base Has 1/32" Vent 5) Base Has 1/4" Vent 6) Base Has 11/16" Vent 7) Base Has 1-1/8" Vent 8) Base Has 13/16" Vent 9) Base Has 13/32" Vent 10) Base Has 13/64" Vent 11) Base Has 2-3/16" Square Inlet 12) Base Has 15/64" Vent 13) Base Has 19/32" Vent 14) Base Has 21/32" Vent 15) Base Has 25/64" Vent 16) Base Has 29/32" Vent 17) Base Has 3/16" Vent 18) Base Has 3/4" Vent 19) Base Has 3/8" Vent 20) Base Has 31/64" Vent 21) Base Has 35/64" Vent 22) Base Has 45/64" Vent 23) Base Has 5/16" Vent 24) Base Has 5/8" Vent 25) Base Has 55/64" Vent 26) Base Has 7/16" Vent 27) Base Has 7/8" Vent 28) Base Has 9/16" Vent 29) Base Has Opt. 1/2" Vent 30) Base Has 23/32" Vent 31) Base Has 25/32" Vent 32) Filter Has Molded-in Velocity Stack 33) Filter Is Reverse Tapered 34) Fits Legend/Dwarf Race Cars w/F1J1200 Motors 35) Base Has 15/32" Vent 36) Top Plate Has 1/4-20 Stud 37) Top-Plate Has 6MM Stud 39) Offset Is Vertical 41) Offset Is Vertical And To The Right 42) Top Has 1/2" Vent 43) Top Has 1-1/16" Center Hole 44) Top Has 21/32" Center Hole 45) Top Has 23/32" Center Hole 46) Top Has 5/32" Center Hole 47) Top Has 7/16" Center Hole 48) Base Has 11/32" Vent 49) Top Has 1/4" Center Hole 50) Top Has 1-7/16" Center Hole 51) 2-1/2" Adapter Included 52) Top Has 5/8" Vent 53) Tapered Insert Included 5" to 4-3/8" 54) Filter Has Thru Hole 2-3/4" x 1-5/8"

(F) Mounting Flange Inside Diameter		(D) Filter Base Diameter		(D) Filter Top Diameter		(L) Filter Length		(FL) Flange Length		(FA) Flange Style		(FO) Flange Offset		Rubber End Cap Part #	Chrome End Cap Part #	Custom End Cap Part #	Filter Wraps Part #
Inch	mm	Inch	mm	Inch	mm	Inch	mm	Inch	mm	Type	Angle	Inch	mm				
2-3/4	70	4-3/4	121	3-1/2	89	5-7/8	149	13/16	21	Centered					RC-9310		RC-9310DK
		4-3/4	121	4	102	7-7/8	200	13/16	21	Centered					RC-5144		RC-4690DK
		5-1/16	129	3-1/2	89	3-3/16	81	3/4	19	Centered					RC-5127		
		5-1/16	129	3-1/2	89	4	102	3/4	19	Centered					RC-5128		
		5-1/16	129	3-1/2	89	4-3/8	111	3/4	19	Centered					RC-5135		
		5-1/16	129	3-1/2	89	5-1/2	140	3/4	19	Centered					RC-5131		
		5-3/16	132	3-1/2	89	4-11/32	110	3/4	19	Offset		19/32	15		RC-8410 ¹⁷		
		5-3/16	132	3-1/2	89	4-5/16	110	3/4	19	Offset		1/2	13		RC-4490 ^{6,23}		
		5-3/16	132	3-1/2	89	4-3/8	111	3/4	19	Offset		17/32	13		RC-9980 ^{21,22}		
		5-3/16	132	3-1/2	89	4-31/32	126	5/8	16	Offset		19/32	15		RC-8470 ^{38,40}		
		5-3/16	132	3-1/2	89	5-1/8	130	3/4	19	Offset		11/16	17		RC-4500 ²		25-3900
		5-1/2	140	4-1/2	114	7	178	2-1/2	64	Angled	30°				RC-4790		25-3900
		5-3/4	146	5-15/16	151	7-11/16	195	7/16	11	Centered						RR-3004	
		5-7/8	149	4-1/2	114	5	127	3/4	19	Centered					RC-5284		
		5-7/8	149	4-3/4	121	2-5/8	67	3/4	19	Centered				RU-3390			
		5-7/8	149	4-3/4	121	5	127	3/4	19	Centered				RU-4450			25-3900
		5-7/8	149	4-3/4	121	7	178	3/4	19	Centered				RU-3610			25-3900
		5-7/8	149	5-1/4	133	5	127	3/4	19	Centered						RR-2803	
		6	152	5	127	5-1/2	140	2	51	Centered				RU-4960XD		RX-4960 ¹	RX-4990DK
		6	152	5	127	6-1/2	165	2	51	Centered				RU-4870		RX-4870	RX-4730DK
		6	152	5-1/4	133	5-1/4	133	1-1/2	38	Centered				RU-3103HB			
		6-3/4	171	5-7/8	149	3-1/4	83	3/4	19	Centered					RC-4850 ¹	E-2232	
		6-7/8	175	5-7/8	149	2-5/8	67	3/4	19	Centered					RC-9880		
2-13/16	71	4-7/16	113	3-1/2	89	5	127	3-9/16	90	Centered					RC-4510 ⁶		25-3900
		6-7/8	175	5-7/8	149	3-1/8	79	3/4	19	Offset		3/4	19		RC-4640 ⁴		
2-27/32	72	5-3/16	132	3-3/4	95	3-3/4	95	3/4	19	Offset		9/16	14	RU-5146			
2-7/8	73	4	102	3	76	5	127	5/8	16	Centered					RC-2600		25-3900
		4-1/4	108	4	102	4-3/4	121	15/16	24	Centered						RX-4020-1 ¹	
		4-1/2	114	3-1/2	89	5-7/8	149	3/4	19	Centered					RC-5136		25-3900
		5-3/16	132	3-1/2	89	4-7/16	113	3/4	19	Offset		15/32	12		RC-4570 ⁶		
		5-3/16	132	3-1/2	89	4-1/2	114	2-7/8	73	Offset		1/2	13		RC-8390		
2-29/32	74	4-21/32	118	2-5/16	59	5-29/32	150	23/32	18	Centered				RU-9220			25-3900
2-15/16	75	6-3/4	171	5-7/8	149	3-1/8	79	3/4	19	Offset		13/16	21		RC-4770 ⁴		
3	76	4-1/2	114	3-1/2	89	4-5/16	110	3/4	19	Centered					RC-9410		
		4-1/2	114	3-1/2	89	5-3/4	146	3/4	19	Centered				RU-5111			25-3900
		4-1/2	114	6	152	4-5/8	117	7/8	22	Centered						RX-3900-1 ¹	
		5	127	3-1/2	89	4-5/8	117	3/4	19	Centered					RC-9480		
		5	127	3-1/2	89	5-15/16	151	3/4	19	Centered					RC-9640		
		5	127	3-1/2	89	6	152	1-3/4	44	Centered					RF-1039		RC-4160DK
		5	127	4	102	6	152	1-3/4	44	Centered					RC-4650		RC-4650DK
		5	127	4	102	7-7/8	200	1-1/4	32	Centered					RC-4690		RC-4690DK
		5	127	4-1/2	114	5	127	1-3/4	44	Centered					RC-3870		25-3900
		5	127	4-1/2	114	6-1/2	165	1-13/16	46	Centered					RF-1030		RC-4630DK
		5	127	4-5/8	117	4	102	1-3/4	44	Centered					RU-3700		22-8014PK
		5	127	4-5/8	117	8	203	1-3/4	44	Centered					RE-0910		RE-0910PK

1) 1/4-20 Jack Nut Into Top 2) Base Has (2) 7/8" Vents 3) Base Has 1/2" Vent 4) Base Has 1/32" Vent 5) Base Has 1/4" Vent 6) Base Has 11/16" Vent 7) Base Has 1-1/8" Vent 8) Base Has 13/16" Vent 9) Base Has 13/32" Vent 10) Base Has 13/64" Vent 11) Base Has 2-3/16" Square Inlet 12) Base Has 15/64" Vent 13) Base Has 19/32" Vent 14) Base Has 21/32" Vent 15) Base Has 25/64" Vent 16) Base Has 29/32" Vent 17) Base Has 3/16" Vent 18) Base Has 3/4" Vent 19) Base Has 3/8" Vent 20) Base Has 31/64" Vent 21) Base Has 35/64" Vent 22) Base Has 45/64" Vent 23) Base Has 5/16" Vent 24) Base Has 5/8" Vent 25) Base Has 55/64" Vent 26) Base Has 7/16" Vent 27) Base Has 7/8" Vent 28) Base Has 9/16" Vent 29) Base Has Opt. 1/2" Vent 30) Base Has 23/32" Vent 31) Base Has 25/32" Vent 32) Filter Has Molded-in Velocity Stack 33) Filter Is Reverse Tapered 34) Fits Legend/Dwarf Race Cars w/F1200 Motors 35) Base Has 15/32" Vent 36) Top Plate Has 1/4-20 Stud 37) Top-Plate Has 6MM Stud 39) Offset Is Vertical 41) Offset Is Vertical And To The Right 42) Top Has 1/2" Vent 43) Top Has 1-1/16" Center Hole 44) Top Has 21/32" Center Hole 45) Top Has 23/32" Center Hole 46) Top Has 5/32" Center Hole 47) Top Has 7/16" Center Hole 48) Base Has 11/32" Vent 49) Top Has 1/4" Center Hole 50) Top Has 1-7/16" Center Hole 51) 2-1/2" Adapter Included 52) Top Has 5/8" Vent 53) Tapered Insert Included 5" to 4-3/8" 54) Filter Has Thru Hole 2-3/4" x 1-5/8"



Round Tapered

(F) Mounting Flange Inside Diameter		(D) Filter Base Diameter		(D) Filter Top Diameter		(L) Filter Length		(FL) Flange Length		(FA) Flange Style		(FO) Flange Offset		Rubber End Cap Part #	Chrome End Cap Part #	Custom End Cap Part #	Filter Wraps Part #
Inch	mm	Inch	mm	Inch	mm	Inch	mm	Inch	mm	Type	Angle	Inch	mm				
3	76	5-1/8	130	5-3/8	137	4-1/2	114	1-1/2	38	Centered						HA-4099	22-8016PK
		6	152	3-1/2	89	6	152	1-3/4	44	Centered					RC-4290		
		6	152	4	102	5	127	1-3/4	44	Centered			RU-3580				25-3900
		6	152	4	102	6-3/4	171	1-3/4	44	Centered					RC-4700		RC-4700DK
		6	152	4	102	8-11/16	221	15/16	24	Centered						RX-3990-1 ¹	
		6	152	4-1/2	114	6	152	1-3/4	44	Centered					RC-4180		22-8033PK
		6	152	4-1/2	114	8	203	1-3/4	44	Centered					RC-5106		RC-5106DK
		6	152	4-5/8	117	6	152	1-3/4	44	Centered			RE-0930				22-8033PK
		6	152	4-5/8	117	9	229	1-3/4	44	Centered			RE-0810				25-0810
		6	152	4-5/8	117	12	305	1-3/4	44	Centered			RE-0800				22-8034PK
		6	152	4-5/8	117	14	356	1-3/4	44	Centered			RE-0820				22-8035PK
		6	152	4-3/4	121	6	152	1-3/4	44	Centered			RE-0930-L				
		6	152	5	127	5	127	1-3/4	44	Centered			RU-5176				RX-4990DK
		6	152	5	127	5-9/16	141	1-3/4	44	Centered			RU-4990			RX-4990 ¹	RX-4990DK
		6	152	5	127	6	152	1-3/4	44	Centered					RF-1047		25-3900
		6	152	5	127	6-1/2	165	1-3/4	44	Centered			RU-4730			RX-4730XD ¹	RX-4730DK
		6	152	5-1/8	130	5	127	1-3/4	44	Centered			RU-3570				RX-4990DK
		6	152	5-1/4	133	5	127	1-3/4	44	Centered						RR-3003	
		6	152	5-7/8	149	6	152	1-3/4	44	Centered					RD-1100		
3-1/8	79	4-7/8	124	3-1/2	89	5-7/16	138	23/32	18	Centered					RC-9240		
		4-15/16	125	3-1/2	89	3-15/16	100	3/4	19	Centered					RC-9270		
		4-15/16	125	3-1/2	89	4-3/8	111	15/16	24	Centered					RC-9160		
		4-15/16	125	3-1/2	89	4-5/8	117	3/4	19	Centered					RC-8220		
		4-15/16	125	3-1/2	89	6	152	15/16	24	Centered					RC-8250		
		5	127	3-1/2	89	6	152	3/4	19	Centered					RC-9320		RC-4160DK
		6	152	4-5/8	117	14	356	1-3/4	44	Centered			RE-0940				
		6	152	5	127	7	178	1-3/4	44	Centered					RC-5100		RC-5100DK
3-5/32	80	5-3/4	146	3-1/2	89	4-7/16	113	3/4	19	Offset		1/2	13		RC-9110 ⁴		
		5-25/32	147	3-1/2	89	4-17/32	115	25/32	20	Offset		15/32	12		RC-9670 ¹⁶		
		5-25/32	147	3-1/2	89	4-17/32	115	3/4	19	Offset		1/2	13		RC-9910		
		5-25/32	147	3-1/2	89	5-15/32	139	3/4	19	Offset		1/2	13		RC-8370 ⁴⁰		
		5-25/32	147	3-1/2	89	7-23/32	196	5/8	16	Centered					RC-9950 ^{38,19,1}		
		6-15/16	176	3-1/2	89	7	178	3/4	19	Offset		25/32	20		RC-8450		
3-1/4	83	4-15/16	125	3-1/2	89	4-7/8	124	15/16	24	Centered					RC-9610		
		5-1/2	140	4-1/2	114	8	203	5/8	16	Centered					RF-1025 ¹⁹		RC-5106DK
		5-1/2	140	4-11/16	119	8	203	1-5/8	41	Centered			RU-5122				RC-5106DK
		5-3/4	146	3-1/2	89	4-25/32	121	3/4	19	Offset		9/16	14		RC-9660 ⁴		
		5-3/4	146	3-1/2	89	5-7/16	138	25/32	20	Offset		7/16	11		RC-1637		
		5-3/4	146	3-1/2	89	6-5/8	168	3/4	19	Offset		1/2	13		RC-4560 ²		25-3900
		5-3/4	146	3-1/2	89	6-11/16	170	3/4	19	Offset		1/2	13		RC-4470		25-3900
3-5/16	84	3-15/16	100	3-7/16	87	5-1/8	130	1/2	13	Centered						YA-4003	KA-3603PK
		4-3/4	121	3-1/2	89	4-3/8	111	3/4	19	Centered					RC-9770		
		4-3/4	121	3-1/2	89	6	152	3/4	19	Centered					RC-4540		25-3900
		4-3/4	121	3-1/2	89	6-1/2	165	5/8	16	Centered			RU-2710	RC-2710			25-3900
		4-7/8	124	4	102	4-1/4	108	15/16	24	Centered						RX-4120-1 ¹	

1) 1/4-20 Jack Nut Into Top 2) Base Has (2) 7/8" Vents 3) Base Has 1/2" Vent 4) Base Has 1/32" Vent 5) Base Has 1/4" Vent 6) Base Has 11/16" Vent 7) Base Has 1-1/8" Vent 8) Base Has 13/16" Vent 9) Base Has 13/32" Vent 10) Base Has 13/64" Vent 11) Base Has 2-3/16" Square Inlet 12) Base Has 15/64" Vent 13) Base Has 19/32" Vent 14) Base Has 21/32" Vent 15) Base Has 25/64" Vent 16) Base Has 29/32" Vent 17) Base Has 3/16" Vent 18) Base Has 3/4" Vent 19) Base Has 3/8" Vent 20) Base Has 31/64" Vent 21) Base Has 35/64" Vent 22) Base Has 45/64" Vent 23) Base Has 5/16" Vent 24) Base Has 5/8" Vent 25) Base Has 55/64" Vent 26) Base Has 7/16" Vent 27) Base Has 7/8" Vent 28) Base Has 9/16" Vent 29) Base Has Opt. 1/2" Vent 30) Base Has 23/32" Vent 31) Base Has 25/32" Vent 32) Filter Has Molded-in Velocity Stack 33) Filter Is Reverse Tapered 34) Fits Legend/Dwarf Race Cars w/F1J1200 Motors 35) Base Has 15/32" Vent 36) Top Plate Has 1/4-20 Stud 37) Top-Plate Has 6MM Stud 39) Offset Is Vertical 41) Offset Is Vertical And To The Right 42) Top Has 1/2" Vent 43) Top Has 1-1/16" Center Hole 44) Top Has 21/32" Center Hole 45) Top Has 23/32" Center Hole 46) Top Has 5/32" Center Hole 47) Top Has 7/16" Center Hole 48) Base Has 11/32" Vent 49) Top Has 1/4" Center Hole 50) Top Has 1-7/16" Center Hole 51) 2-1/2" Adapter Included 52) Top Has 5/8" Vent 53) Tapered Insert Included 5" to 4-3/8" 54) Filter Has Thru Hole 2-3/4" x 1-5/8"

(F) Mounting Flange Inside Diameter		(D) Filter Base Diameter		(D) Filter Top Diameter		(L) Filter Length		(FL) Flange Length		(FA) Flange Style		(FO) Flange Offset		Rubber End Cap Part #	Chrome End Cap Part #	Custom End Cap Part #	Filter Wraps Part #
Inch	mm	Inch	mm	Inch	mm	Inch	mm	Inch	mm	Type	Angle	Inch	mm				
3-5/16	84	5-3/4	146	3-1/2	89	5-7/16	138	25/32	20	Offset		7/16	11		RC-8110 ²⁸		
3-3/8	86	4-15/16	125	3-1/2	89	3-7/8	98	15/16	24	Centered					RC-9790		
		5-3/4	146	3-1/2	89	4-1/4	108	3/4	19	Offset		9/16	14		RC-8200 ^{3,4}		
		5-3/4	146	3-1/2	89	4-7/16	113	3/4	19	Offset		9/16	14		RC-9970 ⁴		
		5-3/4	146	3-1/2	89	4-7/8	124	3/4	19	Offset		9/16	14		RC-8000 ¹⁸		
		5-3/4	146	3-1/2	89	5-7/16	138	3/4	19	Offset		5/8	16		RC-9120 ³⁵		
		5-3/4	146	3-1/2	89	6-15/16	176	3/4	19	Offset		9/16	14		RC-8150		
		5-13/16	148	4	102	6	152	5/8	16	Centered				RU-5168			RU-5168DK
		6	152	4-1/2	114	9	229	3/4	19	Centered						RP-5118	RC-3690DK
3-13/32	87	5-13/16	148	3-1/2	89	7-27/32	199	3/4	19	Offset		1	25		RC-8260 ³⁸		
3-1/2	89	4-5/8	117	3-1/2	89	3	76	5/8	16	Centered				RU-4410			
		4-5/8	117	3-1/2	89	4-1/2	114	5/8	16	Centered				RU-2790			
		4-5/8	117	3-1/2	89	5-1/2	140	5/8	16	Centered				RU-3550			25-3900
		4-5/8	117	3-1/2	89	7	178	5/8	16	Centered				RU-3130-L			RU-3130DK
		5	127	3-1/2	89	4	102	5/8	16	Centered				RU-2990			
		5	127	5-1/8	130	2	51	5/8	16	Centered					RC-4230 ¹⁶		
		5-1/2	140	4	102	8	203	1-1/4	32	Centered				RF-1045			RF-1045DK
		5-1/2	140	4-1/2	114	6-1/2	165	1-1/4	32	Centered				RC-4630XD	RP-4630		RC-4630DK
		5-1/2	140	4-1/2	114	8	203	1-1/4	32	Centered				RC-4760			RC-5106DK
		5-3/4	146	3-1/2	89	6	152	1-3/4	44	Angled	10°			RF-1035			RF-1035DK
		5-3/4	146	3-3/4	95	6	152	1-3/4	44	Angled	10°			RF-1031			RU-5168DK
		5-3/4	146	4-1/2	114	6	152	1-3/4	44	Angled	10°			RF-1023			22-8033PK
		5-3/4	146	5	127	7	178	1-3/4	44	Angled	10°			RF-1016 ²			25-3900
		5-3/4	146	5	127	8	203	1-3/4	44	Angled	10°			RF-1003 ²			
		5-3/4	146	5	127	12-1/8	308	1-3/4	44	Angled	10°			RF-1004 ²			
		6	152	4-1/2	114	9	229	1-3/4	44	Centered				RC-3690			RC-3690DK
		6	152	4-5/8	117	6	152	1-3/4	44	Centered				RE-0950			22-8033PK
		6	152	4-5/8	117	9	229	1-3/4	44	Centered				RE-0920			RE-0810PK
		6	152	5-1/4	133	9-1/2	241	1-1/2	38	Centered				RU-3105HB			
		8	203	6-5/8	168	8	203	1-1/2	38	Centered				RC-5112			RC-5112DK
		8	203	7	178	12-1/2	318	1-1/2	38	Centered				RC-5165			RC-5165DK
3-5/8	92	4	102	3-3/4	95	6	152	5/8	16	Centered				RD-6010			
3-3/4	95	5-3/8	137	4-3/8	111	5	127	5/8	16	Centered				RU-4250			25-3900
		5-3/8	137	4-3/8	111	7	178	5/8	16	Centered				RU-3530			RU-2590DK
		5-3/4	146	3-1/2	89	6-3/4	171	3/4	19	Offset		1/2	13		RC-8480		25-3900
3-13/16	97	6-13/16	173	6	152	2-1/8	54	3/4	19	Centered						RX-4130-1 ¹	
3-7/8	98	4-1/4	108	3-1/2	89	4-1/4	108	7/16	11	Centered				RD-6020			
		4-1/4	108	4	102	6	152	7/16	11	Centered				RD-6000			22-8031PK
		6-3/4	171	5-7/8	149	2-3/4	70	3/4	19	Offset		3/8	10		RC-4840 ⁴		
3-27/32	98	6-7/8	175	5-7/8	149	2-25/32	71	3/4	19	Offset		7/16	11		RC-9600		
		6-7/8	175	5-7/8	149	3-3/16	81	3/4	19	Offset		13/32	10		RC-9990 ²⁴		
3-7/8	98	6-15/16	176	3-1/2	89	7-23/32	196	5/8	16	Offset		3/8	10		RC-9540		
3-27/32	98	6-15/16	176	5-13/16	148	3-1/16	78	3/4	19	Offset		197/5	10		RC-9860 ¹⁴		
		6-15/16	176	5-7/8	149	2-5/8	67	3/4	19	Offset		7/16	11		RC-9520 ²⁸		

1) 1/4-20 Jack Nut Into Top 2) Base Has (2) 7/8" Vents 3) Base Has 1/2" Vent 4) Base Has 1/32" Vent 5) Base Has 1/4" Vent 6) Base Has 11/16" Vent 7) Base Has 1-1/8" Vent 8) Base Has 13/16" Vent 9) Base Has 13/32" Vent 10) Base Has 13/64" Vent 11) Base Has 2-3/16" Square Inlet 12) Base Has 15/64" Vent 13) Base Has 19/32" Vent 14) Base Has 21/32" Vent 15) Base Has 25/64" Vent 16) Base Has 29/32" Vent 17) Base Has 3/16" Vent 18) Base Has 3/4" Vent 19) Base Has 3/8" Vent 20) Base Has 31/64" Vent 21) Base Has 35/64" Vent 22) Base Has 45/64" Vent 23) Base Has 5/16" Vent 24) Base Has 5/8" Vent 25) Base Has 55/64" Vent 26) Base Has 7/16" Vent 27) Base Has 7/8" Vent 28) Base Has 9/16" Vent 29) Base Has Opt. 1/2" Vent 30) Base Has 23/32" Vent 31) Base Has 25/32" Vent 32) Filter Has Molded-in Velocity Stack 33) Filter Is Reverse Tapered 34) Fits Legend/Dwarf Race Cars w/F1200 Motors 35) Base Has 15/32" Vent 36) Top Plate Has 1/4-20 Stud 37) Top-Plate Has 6MM Stud 39) Offset Is Vertical 41) Offset Is Vertical And To The Right 42) Top Has 1/2" Vent 43) Top Has 1-1/16" Center Hole 44) Top Has 21/32" Center Hole 45) Top Has 23/32" Center Hole 46) Top Has 5/32" Center Hole 47) Top Has 7/16" Center Hole 48) Base Has 11/32" Vent 49) Top Has 1/4" Center Hole 50) Top Has 1-7/16" Center Hole 51) 2-1/2" Adapter Included 52) Top Has 5/8" Vent 53) Tapered Insert Included 5" to 4-3/8" 54) Filter has Thru Hole 2-3/4" x 1-5/8"



Round Tapered

(F) Mounting Flange Inside Diameter		(D) Filter Base Diameter		(D) Filter Top Diameter		(L) Filter Length		(FL) Flange Length		(FA) Flange Style		(FO) Flange Offset		Rubber End Cap Part #	Chrome End Cap Part #	Custom End Cap Part #	Filter Wraps Part #
Inch	mm	Inch	mm	Inch	mm	Inch	mm	Inch	mm	Type	Angle	Inch	mm				
3-7/8	98	7-1/2	191	5-1/8	130	7	178	1-1/2	38	Centered					RF-1029 ¹⁹		RF-1029DK
3-15/16	100	5-7/16	138	4-1/2	114	3-5/8	92	3/4	19	Centered					RC-5057		
		5-7/16	138	4-1/2	114	6	152	3/4	19	Centered						RF-1633 ⁴⁷	
		5-1/2	140	4-1/2	114	3-1/4	83	3/4	19	Centered						RC-5153	
		5-1/2	140	4-1/2	114	4-1/2	114	3/4	19	Centered						RC-5059	
		5-1/2	140	4-1/2	114	5	127	3/4	19	Centered					RC-5156		
		5-1/2	140	4-1/2	114	5-15/16	151	3/4	19	Centered					RC-5053		
		5-1/2	140	4-1/2	114	6	152	3/4	19	Centered						RF-1682	
4	102	5-3/8	137	3-1/2	89	6	152	5/8	16	Centered				RU-5141 ³⁵			RP-4660DK
		5-3/8	137	4	102	5-1/16	129	5/8	16	Centered						RP-4930	RP-4660DK
		5-3/8	137	4	102	5-1/2	140	5/8	16	Centered						RP-4660	RP-4660DK
		5-3/8	137	4	102	6-1/2	165	5/8	16	Centered					RC-5149	RP-4980	RC-5149DK
		5-3/8	137	4	102	7	178	5/8	16	Centered						RP-4970	22-8032PK
		5-3/8	137	4-3/8	111	3-1/2	89	5/8	16	Centered				RU-2510			
		5-3/8	137	4-3/8	111	5	127	5/8	16	Centered				RU-2520			25-3900
		5-3/8	137	4-3/8	111	7	178	5/8	16	Centered				RU-2590			RU-2590DK
		5-3/8	137	4-1/2	114	5	127	5/8	16	Centered					RC-3600		25-3900
		5-3/8	137	4-1/2	114	6	152	5/8	16	Centered					RF-1049 ³		RF-1023DK
		5-3/8	137	4-1/2	114	7-1/2	191	5/8	16	Centered					RF-1007 ²		
		5-3/8	137	4-1/2	114	8	203	5/8	16	Centered					RC-4580		
		5-3/8	137	5	127	6-1/2	165	5/8	16	Centered					RF-1018 ⁴²		25-3900
		5-1/2	140	7	178	6	152	3/4	19	Centered					RD-1200 ⁵¹		
		6	152	4	102	7	178	1-3/4	44	Centered					RC-4680		RF-1032DK
		6	152	4	102	8	203	1-3/4	44	Centered					RF-1046		
		6	152	4-1/2	114	7	178	5/8	16	Centered					RF-1015		RF-1015DK
		6	152	4-5/8	117	9	229	1-3/4	44	Centered					RE-0870-L		25-0810
		6	152	4-5/8	117	12	305	1-3/4	44	Centered					RE-0860		22-8034PK
		6	152	4-5/8	117	14	356	1-3/4	44	Centered					RE-0880		22-8035PK
		6	152	4-3/4	121	5-1/2	140	1-1/8	29	Centered					RG-1001WT		
		6	152	4-3/4	121	8-5/8	219	1	25	Centered					E-1997		
		6	152	4-3/4	121	9-1/2	241	1-1/8	29	Centered					RG-1002RD		
		6-1/2	165	4-1/2	114	6	152	1-3/4	44	Centered					RC-5060		RC-5060DK
		6-1/2	165	4-1/2	114	7	178	1-3/4	44	Centered					RF-1032		RF-1032DK
		6-1/2	165	4-1/2	114	8	203	1-3/4	44	Centered					RF-1027		RF-1027DK
		6-5/8	168	5-1/4	133	9-1/2	241	1-11/16	43	Centered						RC-4780 ^{2,29,30}	RC-4780DK
		6-3/4	171	5-7/8	149	9-1/2	241	1-3/4	44	Centered				RU-5045			RU-5045DK
		6-7/8	175	5-7/8	149	2-3/4	70	3/4	19	Offset		1/2	13		RC-9500 ¹⁹		
		8	203	6-5/8	168	8	203	1-1/2	38	Centered					RU-5171HB		25-5166
		8	203	6-5/8	168	12	305	1-1/2	38	Centered						RC-5171	25-5166
4-1/16	103	6-7/8	175	5-7/8	149	2-3/16	56	3/4	19	Offset		15/32	12		RC-4480 ⁴		
		6-7/8	175	5-7/8	149	3-1/8	79	3/4	19	Offset		9/32	7		RC-9470 ⁴⁸		
4-1/8	105	7-3/8	187	6-5/8	168	7-7/8	200	1-1/8	29	Centered						RC-4900 ²⁹	RC-4900DK
		7-3/8	187	7	178	11-1/2	292	1-1/8	29	Centered					RC-5181		RF-1026DK
4-1/4	108	5-1/2	140	5-11/32	136	6	152	843/1000	21	Centered					RC-1645		
		5-7/8	149	4-1/2	114	6-3/4	171	5/8	16	Centered						RP-5167	RF-1037DK

1) 1/4-20 Jack Nut Into Top 2) Base Has (2) 7/8" Vents 3) Base Has 1/2" Vent 4) Base Has 1/32" Vent 5) Base Has 1/4" Vent 6) Base Has 11/16" Vent 7) Base Has 1-1/8" Vent 8) Base Has 13/16" Vent 9) Base Has 13/32" Vent 10) Base Has 13/64" Vent 11) Base Has 2-3/16" Square Inlet 12) Base Has 15/64" Vent 13) Base Has 19/32" Vent 14) Base Has 21/32" Vent 15) Base Has 25/64" Vent 16) Base Has 29/32" Vent 17) Base Has 3/16" Vent 18) Base Has 3/4" Vent 19) Base Has 3/8" Vent 20) Base Has 31/64" Vent 21) Base Has 35/64" Vent 22) Base Has 45/64" Vent 23) Base Has 5/16" Vent 24) Base Has 5/8" Vent 25) Base Has 55/64" Vent 26) Base Has 7/16" Vent 27) Base Has 7/8" Vent 28) Base Has 9/16" Vent 29) Base Has Opt. 1/2" Vent 30) Base Has 23/32" Vent 31) Base Has 25/32" Vent 32) Filter Has Molded-in Velocity Stack 33) Filter Is Reverse Tapered 34) Fits Legend/Dwarf Race Cars w/FJ1200 Motors 35) Base Has 15/32" Vent 36) Top Plate Has 1/4-20 Stud 37) Top Plate Has 6MM Stud 38) Offset Is Vertical 41) Offset Is Vertical And To The Right 42) Top Has 1/2" Vent 43) Top Has 1-1/16" Center Hole 44) Top Has 21/32" Center Hole 45) Top Has 23/32" Center Hole 46) Top Has 5/32" Center Hole 47) Top Has 7/16" Center Hole 48) Base Has 11/32" Vent 49) Top Has 1/4" Center Hole 50) Top Has 1-7/16" Center Hole 51) 2-1/2" Adapter Included 52) Top Has 5/8" Vent 53) Tapered Insert Included 5" to 4-3/8" 54) Filter has Thru Hole 2-3/4" x 1-5/8"

(F) Mounting Flange Inside Diameter		(D) Filter Base Diameter		(D) Filter Top Diameter		(L) Filter Length		(FL) Flange Length		(FA) Flange Style		(FO) Flange Offset		Rubber End Cap Part #	Chrome End Cap Part #	Custom End Cap Part #	Filter Wraps Part #
Inch	mm	Inch	mm	Inch	mm	Inch	mm	Inch	mm	Type	Angle	Inch	mm				
4-3/8	111	5-1/2	140	3-1/2	89	2-3/4	70	7/8	22	Centered					RC-9460		
		5-1/2	140	3-1/2	89	3-5/16	84	7/8	22	Centered					RC-9890		
		5-1/2	140	3-1/2	89	5-3/16	132	15/16	24	Centered					RC-9210		
		6	152	4-5/8	117	6-1/2	165	1-1/4	32	Angled	10°			RU-5061			RX-4990DK
4-1/2	114	5-7/8	149	4	102	6	152	5/8	16	Centered						RP-5101	RU-5168DK
		5-7/8	149	4-1/2	114	4-1/2	114	5/8	16	Centered					RF-1005		
		5-7/8	149	4-1/2	114	5	127	5/8	16	Centered						RT-4610	25-3900
		5-7/8	149	4-1/2	114	6	152	5/8	16	Centered			RU-4740		RP-4740		RF-1023DK
		5-7/8	149	4-1/2	114	8-3/8	213	5/8	16	Centered					RF-1008		RC-5106DK
		5-7/8	149	5	127	3-1/4	83	5/8	16	Centered				RU-3110			
		5-7/8	149	5	127	6	152	5/8	16	Centered				RU-3480			RU-3480PK
		5-7/8	149	5-1/8	130	5	127	5/8	16	Centered				RU-4260			25-3900
		8	203	6-5/8	168	8	203	1-1/2	38	Centered				RU-5283HB			RC-5112DK
		8	203	6-5/8	168	8	203	1-3/8	35	Centered						RC-5283 ²⁹	RC-5112DK
		8	203	6-5/8	168	12	305	1-3/8	35	Centered						RC-5166	25-5166
4-7/8	124	9	229	6-5/8	168	7-15/16	202	1-1/4	32	Centered			RU-5172				RC-5139DK
5	127	6-1/2	165	4-3/8	111	7	178	1	25	Centered			RU-2800				25-3900
		6-1/2	165	4-1/2	114	4-1/8	105	1	25	Centered			RU-5163				RU-5163DK
		6-1/2	165	4-1/2	114	5-1/2	140	1	25	Centered			RU-5147				RU-5147DK
		6-1/2	165	4-1/2	114	5-5/8	143	1	25	Centered						RP-5113	RU-5147DK
		6-1/2	165	5	127	6-1/2	165	1	25	Centered					RF-1037		RF-1037DK
		6-1/2	165	6-3/4	171	5	127	1	25	Centered				RU-5109			25-3900
5-5/8	143	7-1/2	191	5-3/4	146	8	203	1-1/8	29	Centered			E-1993				
6	152	7-1/2	191	4-1/2	114	4	102	1	25	Centered			RU-4600			RT-4600	22-8036PK
		7-1/2	191	4-1/2	114	5	127	1	25	Centered						RT-4590	22-8049DK
		7-1/2	191	4-1/2	114	5	127	5/8	16	Centered					RC-5138		22-8049DK
		7-1/2	191	4-1/2	114	6	152	5/8	16	Centered					RF-1048		RF-1048DK
		7-1/2	191	4-1/2	114	6-1/2	165	5/8	16	Centered					RC-5107		RC-5107DK
		7-1/2	191	4-1/2	114	9	229	5/8	16	Centered					RC-5046		RC-5046DK
		7-1/2	191	5	127	5	127	1	25	Centered					RC-2960XD		22-8049DK
		7-1/2	191	5	127	6	152	1	25	Centered				RU-3100	RF-1036	RP-5168	RF-1036DK
		7-1/2	191	5	127	6	152	5/8	16	Centered					RF-1043		22-8037PK
		7-1/2	191	5	127	6-1/2	165	1	25	Centered					RF-1042XD		RF-1042DK
		7-1/2	191	5	127	7-1/2	191	1	25	Centered					RF-1041		RF-1041DK
		7-1/2	191	5	127	8	203	1	25	Centered				RU-3050	RF-1020		RF-1020DK
		7-1/2	191	5	127	8	203	5/8	16	Centered					RF-1044XD		RF-1020DK
		7-1/2	191	5	127	10	254	1	25	Centered				RU-3280			
		7-1/2	191	5-1/8	130	4	102	1	25	Centered					RF-1009		22-8036PK
		7-1/2	191	5-1/8	130	5	127	1	25	Centered					RC-2960		22-8049DK
		7-1/2	191	5-1/4	133	6	152	1	25	Centered					RU-3102HB		
7-1/2	191	5-1/4	133	7-1/2	191	1	25	Centered					RU-3101HB				
7-1/2	191	5-7/8	149	3	76	1	25	Centered					RF-1028		RF-1028DK		
7-1/2	191	5-7/8	149	6	152	1	25	Centered					RC-4940		RC-5173DK		
7-1/2	191	5-7/8	149	6	152	5/8	16	Centered					RC-5173		RC-5173DK		
7-1/2	191	5-7/8	149	6-1/2	165	1	25	Centered					RF-1014		RF-1014DK		

1) 1/4-20 Jack Nut Into Top 2) Base Has (2) 7/8" Vents 3) Base Has 1/2" Vent 4) Base Has 1/32" Vent 5) Base Has 1/4" Vent 6) Base Has 11/16" Vent 7) Base Has 1-1/8" Vent 8) Base Has 13/16" Vent 9) Base Has 13/32" Vent 10) Base Has 13/64" Vent 11) Base Has 2-3/16" Square Inlet 12) Base Has 15/64" Vent 13) Base Has 19/32" Vent 14) Base Has 21/32" Vent 15) Base Has 25/64" Vent 16) Base Has 29/32" Vent 17) Base Has 3/16" Vent 18) Base Has 3/4" Vent 19) Base Has 3/8" Vent 20) Base Has 31/64" Vent 21) Base Has 35/64" Vent 22) Base Has 45/64" Vent 23) Base Has 5/16" Vent 24) Base Has 5/8" Vent 25) Base Has 55/64" Vent 26) Base Has 7/16" Vent 27) Base Has 7/8" Vent 28) Base Has 9/16" Vent 29) Base Has Opt. 1/2" Vent 30) Base Has 23/32" Vent 31) Base Has 25/32" Vent 32) Filter Has Molded-in Velocity Stack 33) Filter Is Reverse Tapered 34) Fits Legend/Dwarf Race Cars w/FJ1200 Motors 35) Base Has 15/32" Vent 36) Top Plate Has 1/4-20 Stud 37) Top-Plate Has 6MM Stud 38) Offset Is Vertical 41) Offset Is Vertical And To The Right 42) Top Has 1/2" Vent 43) Top Has 1-1/16" Center Hole 44) Top Has 21/32" Center Hole 45) Top Has 23/32" Center Hole 46) Top Has 5/32" Center Hole 47) Top Has 7/16" Center Hole 48) Base Has 11/32" Vent 49) Top Has 1/4" Center Hole 50) Top Has 1-7/16" Center Hole 51) 2-1/2" Adapter Included 52) Top Has 5/8" Vent 53) Tapered Insert Included 5" to 4-3/8" 54) Filter has Thru Hole 2-3/4" x 1-5/8"

Oval Straight

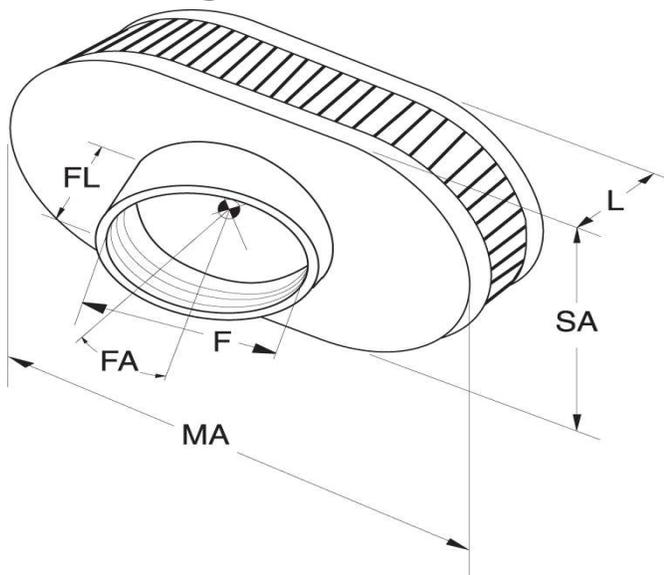

When selecting one of K&N's universal oval air filters, you should consider the following dimensions as they relate to the specification chart:

(F) Mounting Flange Inside Diameter - This is the most critical dimension and should be very close to the diameter of the application's inlet flange. The flange will stretch up to 1/16" for those in-between sizes.

(MA / SA) Filter Oval Dimensions - This is the length and width of the filter. Always use the largest filter practical to fit the application.

(L) Filter Length - This dimension is the length of the filter body only, it does not include the flange length. Always use the longest filter practical for maximum filtration.

(FA / FL) Flange Angle and/or Length - If no angle is listed in the specifications table, then the flange is straight. Any angle listed is in degrees and can be utilized when space is a problem.

(FO) Flange Offset - In some cases the center of the flange is offset from the center of the filter base in order to provide a better fit.

(F) Mounting Flange Inside Diameter		(MA/SA) Filter Dimensions		(L) Filter Length		(FL) Flange Length		(FA) Flange Style		(FO) Flange Offset		Rubber End Cap Part #	Chrome End Cap Part #	Filter Wraps ¹⁴ Part #
Inch	mm	Inch	mm	Inch	mm	Inch	mm	Type	Angle	Inch	mm			
1-1/2	38	3-3/4x4-1/2	95x114	2-3/4	70	1	25	Angled	30°			R-0640		
2-1/16	52	4-1/2x7	114x178	1-1/2	38	7/8	22	Offset		1/2	13	RA-0700 ⁵	RA-070V ⁵	22-2000PL
		4-1/2x7	114x178	2	51	7/8	22	Offset		1/2	13	RA-0710 ⁵	RA-071V ⁵	22-2000PL
		4-1/2x7	114x178	3	76	7/8	22	Offset		1/2	13	RA-0720 ⁵	RA-072V ⁵	22-2020PL
2-1/4	57	4x6-1/4	102x159	4-1/2	114	1	25	Angled	10°			RU-1320		
		4x6-1/4	102x159	6	152	1	25	Angled	10°			RU-1330		
		3-3/4x4-1/2	95x114	4	102	5/8	16	Centered				RU-0990		
		3-3/4x4-1/2	95x114	5	127	5/8	16	Centered				RU-1100		
		3-3/4x4-1/2	95x114	5	127	1	25	Angled	10°			RU-1140		
		3-3/4x4-1/2	95x114	6	152	1	25	Angled	10°			RU-1150		RU-1230PK
		3-3/4x4-1/2	95x114	2	51	5/8	16	Centered				R-1390		22-8023PK
2-7/16	62	4x6-1/4	102x159	4-1/2	114	1	25	Angled	10°			RU-1340		
		4x6-1/4	102x159	5	127	1	25	Angled	10°			RU-1350		
		4x6-1/4	102x159	6	152	1	25	Angled	10°			RU-1360		
		4-1/2x7	114x178	2	51	5/8	16	Centered					RC-1980	22-2000PL
		3-1/4x4-3/8	83x111	6-3/4	171	1-1/8	29	Centered				AT-6091		
		3-3/4x4-1/2	95x114	5	127	5/8	16	Centered				RU-1180		
		3-3/4x4-1/2	95x114	5	127	1	25	Angled	10°			RU-1220		
		3-3/4x4-1/2	95x114	5	127	1-1/4	32	Angled	20°			RU-1371 ²¹		
		3-3/4x4-1/2	95x114	6	152	1	25	Angled	10°			RU-1230		RU-1230PK
		3-3/4x4-1/2	95x114	6	152	1-1/4	32	Angled	20°			RU-1380		RU-1230PK
		3-3/4x4-1/2	95x114	7	178	5/8	16	Centered				RU-1810		RU-1240PK
		3-3/4x4-1/2	95x114	7	178	1	25	Angled	10°			RU-1240		RU-1240PK
		3-3/4x4-1/2	95x114	7	178	1-1/4	32	Angled	20°			RU-1390		RU-1240PK
3-3/4x4-1/2	95x114	9	229	1	25	Angled	10°			RU-1260		RU-1260PK		
2-1/2	64	3-3/4x4-1/2	95x114	7	178	2-1/8	54	Angled	10°			RU-1830		RU-1240PK

1) 1/4-20 Jack Nut Into Top 2) Base Has (2) 7/8" Vents 3) Base Has 1/2" Vent 4) Base Has 1/32" Vent 5) Base Has 1/4" Vent 6) Base Has 11/16" Vent 7) Base Has 1-1/8" Vent 8) Base Has 13/16" Vent 9) Base Has 13/32" Vent 10) Base Has 13/64" Vent 11) Base Has 2-3/16" Square Inlet 12) Base Has 15/64" Vent 13) Base Has 19/32" Vent 14) Base Has 21/32" Vent 15) Base Has 25/64" Vent 16) Base Has 29/32" Vent 17) Base Has 3/16" Vent 18) Base Has 3/4" Vent 19) Base Has 3/8" Vent 20) Base Has 31/64" Vent 21) Base Has 35/64" Vent 22) Base Has 45/64" Vent 23) Base Has 5/16" Vent 24) Base Has 5/8" Vent 25) Base Has 55/64" Vent 26) Base Has 7/16" Vent 27) Base Has 7/8" Vent 28) Base Has 9/16" Vent 29) Base Has Opt. 1/2" Vent 30) Base Has 23/32" Vent 31) Base Has 25/32" Vent 32) Filter Has Molded-in Velocity Stack 33) Filter Is Reverse Tapered 34) Fits Legend/Dwarf Race Cars w/FJ1200 Motors 35) Base Has 15/32" Vent 36) Top Plate Has 1/4-20 Stud 37) Top-Plate Has 6MM Stud 39) Offset Is Vertical 41) Offset Is Vertical And To The Right 42) Top Has 1/2" Vent 43) Top Has 1-1/16" Center Hole 44) Top Has 21/32" Center Hole 45) Top Has 23/32" Center Hole 46) Top Has 5/32" Center Hole 47) Top Has 7/16" Center Hole 48) Base Has 11/32" Vent 49) Top Has 1/4" Center Hole 50) Top Has 1-7/16" Center Hole 51) 2-1/2" Adapter Included 52) Top Has 5/8" Vent 53) Tapered Insert Included 5" to 4-3/8" 54) Filter has Thru Hole 2-3/4" x 1-5/8"

(F) Mounting Flange Inside Diameter		(MA/SA) Filter Dimensions		(L) Filter Length		(FL) Flange Length		(FA) Flange Style		(FO) Flange Offset		Rubber End Cap Part #	Chrome End Cap Part #	Filter Wraps ¹⁴ Part #	
Inch	mm	Inch	mm	Inch	mm	Inch	mm	Type	Angle	Inch	mm				
2-1/2	64	3-3/4x4-1/2	95x114	9	229	2-1/8	54	Angled	10°			RU-1840		RU-1260PK	
2-9/16	65	4-1/2x7	114x178	1-1/2	38	7/8	22	Offset		1/2	13	RA-0750	RA-075V	22-2000PL	
		4-1/2x7	114x178	2	51	7/8	22	Offset		1/2	13	RA-0760	RA-076V	22-2000PL	
		4-1/2x7	114x178	3	76	7/8	22	Offset		1/2	13	RA-0770	RA-077V	22-2020PL	
2-3/4	70	4x6-1/4	102x159	5	127	5/8	16	Centered				RU-1500	RC-1500		
		4x6-1/4	102x159	5	127	1	25	Angled	10°			RU-1530			
		4x6-1/4	102x159	6	152	1	25	Angled	10°			RU-1540	RC-1540		
		4x6-1/4	102x159	7	178	5/8	16	Centered				RU-1520	RC-1520		
		4x6-1/4	102x159	7	178	1	25	Angled	10°			RU-1550			
		4-1/2x7	114x178	2	51	5/8	16	Centered						RC-2000	22-2000PL
		4-1/2x7	114x178	3	76	5/8	16	Centered						RC-2860	22-2020PL
3-1/2	89	4-1/2x7	114x178	7	178	5/8	16	Centered				RU-3620			
		4-1/2x7	114x178	3-1/2	89	5/8	16	Centered					RC-3180	E-3341PK	

1) 1/4-20 Jack Nut Into Top 2) Base Has (2) 7/8" Vents 3) Base Has 1/2" Vent 4) Base Has 1/32" Vent 5) Base Has 1/4" Vent 6) Base Has 11/16" Vent 7) Base Has 1-1/8" Vent 8) Base Has 13/16" Vent 9) Base Has 13/32" Vent 10) Base Has 13/64" Vent 11) Base Has 2-3/16" Square Inlet 12) Base Has 15/64" Vent 13) Base Has 19/32" Vent 14) Base Has 21/32" Vent 15) Base Has 25/64" Vent 16) Base Has 29/32" Vent 17) Base Has 3/16" Vent 18) Base Has 3/4" Vent 19) Base Has 3/8" Vent 20) Base Has 31/64" Vent 21) Base Has 35/64" Vent 22) Base Has 45/64" Vent 23) Base Has 5/16" Vent 24) Base Has 5/8" Vent 25) Base Has 55/64" Vent 26) Base Has 7/16" Vent 27) Base Has 7/8" Vent 28) Base Has 9/16" Vent 29) Base Has Opt. 1/2" Vent 30) Base Has 23/32" Vent 31) Base Has 25/32" Vent 32) Filter Has Molded-in Velocity Stack 33) Filter Is Reverse Tapered 34) Fits Legend/Dwarf Race Cars w/F1J1200 Motors 35) Base Has 15/32" Vent 36) Top Plate Has 1/4-20 Stud 37) Top-Plate Has 6MM Stud 39) Offset Is Vertical 41) Offset Is Vertical And To The Right 42) Top Has 1/2" Vent 43) Top Has 1-1/16" Center Hole 44) Top Has 21/32" Center Hole 45) Top Has 23/32" Center Hole 46) Top Has 5/32" Center Hole 47) Top Has 7/16" Center Hole 48) Base Has 11/32" Vent 49) Top Has 1/4" Center Hole 50) Top Has 1-7/16" Center Hole 51) 2-1/2" Adapter Included 52) Top Has 5/8" Vent 53) Tapered Insert Included 5" to 4-3/8" 54) Filter has Thru Hole 2-3/4" x 1-5/8"

Oval Tapered

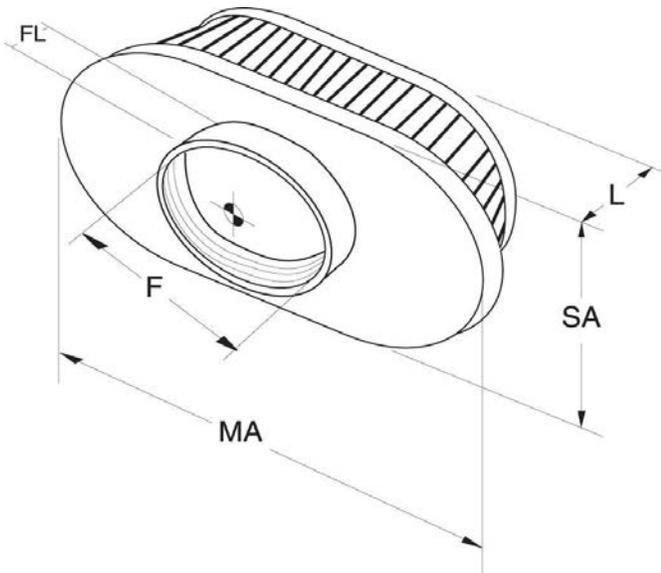

When selecting one of K&N's universal oval air filters, you should consider the following dimensions as they relate to the specification chart:

(F) Mounting Flange Inside Diameter - This is the most critical dimension and should be very close to the diameter of the application's inlet flange. The flange will stretch up to 1/16" for those in-between sizes.

(MA / SA) Filter Oval Dimensions - This is the length and width of the filter. Always use the largest filter practical to fit the application.

(L) Filter Length - This dimension is the length of the filter body only, it does not include the flange length. Always use the longest filter practical for maximum filtration.

(FA / FL) Flange Angle and/or Length - If no angle is listed in the specifications table, then the flange is straight. Any angle listed is in degrees and can be utilized when space is a problem.

(FO) Flange Offset - In some cases the center of the flange is offset from the center of the filter base in order to provide a better fit.

(F) Mounting Flange Inside Diameter	(MA/SA) Filter Base Dimensions		(MA/SA) Filter Top Dimensions		(L) Filter Length		(FL) Flange Length		(FA) Flange Style	(FO) Flange Offset		Rubber End Cap Part #	Chrome End Cap Part #	Custom End Cap Part #	Filter Wraps Part #
	Inch	mm	Inch	mm	Inch	mm	Inch	mm	Type Angle	Inch	mm				
1-3/4 44	2-7/8x4	73x102	2x3	51x76	2-3/4	70	5/8	16	Offset	1/2	13		RC-2450 ⁷		RC-1820DK
	3x4	76x102	2-1/2x3-1/2	64x89	2-3/4	70	5/8	16	Offset	1/2	13	RU-2450 ⁷			RU-0981DK
2 51	3x4	76x102	2x3	51x76	2-3/4	70	5/8	16	Offset	1/2	13		RC-1820 ⁷		RC-1820DK
	3x4	76x102	2x3	51x76	5	127	5/8	16	Offset	1/2	13		RC-2770 ⁷		
	3x4	76x102	2-1/2x3-1/2	64x89	2-3/4	70	5/8	16	Offset	1/2	13	RU-1820 ⁷			RU-0981DK
2-1/8 54	2-7/8x4	73x102	2-1/2x3-1/2	64x89	4	102	5/8	16	Offset	7/16	11	RU-2980 ⁷			
	3x4	76x102	2x3	51x76	2-3/4	70	5/8	16	Offset	7/16	11		RC-0981		RC-1820DK
	3x4	76x102	2x3	51x76	4	102	5/8	16	Offset	7/16	11		RC-2900 ⁷		RC-2890DK
	3x4	76x102	2-1/2x3-1/2	64x89	2-3/4	70	5/8	16	Offset	7/16	11	RU-3010 ⁹			RU-0981DK
	3x4	76x102	2-1/2x3-1/2	64x89	4	102	5/8	16	Offset	7/16	11	RU-2810 ⁷			
	3x4	76x102	2-1/2x3-1/2	64x89	5	127	5/8	16	Offset	7/16	11	RU-2750 ⁷			
2-3/8 60	3-1/2x4-7/8	89x124	2x3	51x76	5-1/2	140	7/8	22	Centered				RC-70040		
	4-1/2x5-3/16	114x132	3-5/16x3-1/2	84x89	4-13/32	112	3/4	19	Offset	5/8	16		RC-70032 ⁴		
2-7/16 62	3-3/4x4-1/2	95x114	2x3	51x76	4	102	5/8	16	Centered					RE-0961	RE-0961DK
	3-3/4x4-1/2	95x114	2x3	51x76	6	152	5/8	16	Centered				RC-3680		22-8051PK
	3-3/4x4-1/2	95x114	2-1/2x3-1/2	64x89	2-3/4	70	5/8	16	Centered			RU-2780 ⁷			RU-2780DK
	3-3/4x4-1/2	95x114	2-1/2x3-1/2	64x89	3-1/2	89	5/8	16	Centered			RU-3780			
	3-3/4x4-1/2	95x114	2-1/2x3-1/2	64x89	5	127	1-1/4	32	Angled 20°			SN-2540			SN-2540PK
	3-3/4x4-1/2	95x114	2-1/2x3-1/2	64x89	6	152	1-1/4	32	Angled 20°			SN-2550			SN-2550PK
	3-3/4x4-1/2	95x114	2-1/2x3-1/2	64x89	6	152	5/8	16	Centered					RE-0960	
2-1/2 64	4-7/32x4-17/32	115x115	3-5/16x4-7/16	84x113	5-1/2	140	2-7/16	62	Angled 9°				RC-70050		
2-3/4 70	3-3/4x4-3/4	95x121	4x4	102x102	5-9/16	141	13/16	21	Centered					RX-5090 ¹	
3 76	6x8	152x203	5x5	127x127	6-1/2	165	1-7/8	48	Centered					RX-4750 ¹	RF-1042DK
3-1/2 89	5-1/4x8-1/2	133x216	4x6-1/4	102x159	5-1/2	140	3/4	19	Centered				RC-5040		RC-5040DK

1) 1/4-20 Jack Nut Into Top 2) Base Has (2) 7/8" Vents 3) Base Has 1/2" Vent 4) Base Has 1/32" Vent 5) Base Has 1/4" Vent 6) Base Has 11/16" Vent 7) Base Has 1-1/8" Vent 8) Base Has 13/16" Vent 9) Base Has 13/32" Vent 10) Base Has 13/64" Vent 11) Base Has 2-3/16" Square Inlet 12) Base Has 15/64" Vent 13) Base Has 19/32" Vent 14) Base Has 21/32" Vent 15) Base Has 25/64" Vent 16) Base Has 29/32" Vent 17) Base Has 3/16" Vent 18) Base Has 3/4" Vent 19) Base Has 3/8" Vent 20) Base Has 31/64" Vent 21) Base Has 35/64" Vent 22) Base Has 45/64" Vent 23) Base Has 5/16" Vent 24) Base Has 5/8" Vent 25) Base Has 55/64" Vent 26) Base Has 7/16" Vent 27) Base Has 7/8" Vent 28) Base Has 9/16" Vent 29) Base Has Opt. 1/2" Vent 30) Base Has 23/32" Vent 31) Base Has 25/32" Vent 32) Filter Has Molded-in Velocity Stack 33) Filter Is Reverse Tapered 34) Fits Legend/Dwarf Race Cars w/FJ1200 Motors 35) Base Has 15/32" Vent 36) Top Plate Has 1/4-20 Stud 37) Top-Plate Has 6MM Stud 39) Offset Is Vertical 41) Offset Is Vertical And To The Right 42) Top Has 1/2" Vent 43) Top Has 1-1/16" Center Hole 44) Top Has 21/32" Center Hole 45) Top Has 23/32" Center Hole 46) Top Has 5/32" Center Hole 47) Top Has 7/16" Center Hole 48) Base Has 11/32" Vent 49) Top Has 1/4" Center Hole 50) Top Has 1-7/16" Center Hole 51) 2-1/2" Adapter Included 52) Top Has 5/8" Vent 53) Tapered Insert Included 5" to 4-3/8" 54) Filter Has Thru Hole 2-3/4" x 1-5/8"

(F) Mounting Flange Inside Diameter		(MA/SA) Filter Base Dimensions		(MA/SA) Filter Top Dimensions		(L) Filter Length		(FL) Flange Length		(FA) Flange Style	(FO) Flange Offset	Rubber End Cap Part #	Chrome End Cap Part #	Custom End Cap Part #	Filter Wraps Part #
Inch	mm	Inch	mm	Inch	mm	Inch	mm	Inch	mm	Type Angle	Inch mm				
3-1/2	89	5-3/4x5-3/4	146x146	3-1/4x4-1/2	83x114	6	152	1-3/4	44	Angled 10°			RC-4400		
		5-3/4x5-3/4	146x146	3-1/4x4-1/2	83x114	7	178	1-3/4	44	Angled 10°				RF-1033	
		6x6	152x152	3-3/4x4-1/2	95x114	5	127	1-3/4	44	Centered		RU-4190			
3-11/16	1694	5-1/2x8-3/4	140x222	3-3/16x6-3/8	81x162	7	178	2-1/8	54	Centered				RP-5285	
3-9/17	199	5-3/8x7-1/2	137x191	3-5/16x4-7/16	84x113	6-1/2	165	1-3/8	35	Centered				RC-5152	
3-29/32	99	5-1/2x7-1/2	140x191	3-5/16x4-1/2	84x114	6-1/2	165	1-1/2	38	Centered				RC-5132	
3-15/16	1600	5-1/4x6-15/16	133x176	3-1/4x4-1/2	83x114	4-15/16	125	1-15/32	37	Centered			RC-1681 ²⁶		
		5-5/16x6-7/8	135x175	3-1/4x4-1/2	83x114	5	127	1-1/2	38	Centered			RC-70031		RC-70031DK
		5-5/16x6-11/16	135x170	3-1/4x4-1/2	83x114	5	127	1-15/32	37	Centered			RC-1605 ⁵		
		5-5/16x7-1/8	135x181	3-1/4x4-1/2	83x114	5	127	1-7/16	37	Centered			RC-5129 ³		
		5-5/16x7-1/8	135x181	3-1/2x3-1/2	89x89	5	127	1-15/16	49	Centered			RC-5056 ^{37,3}		
		5-3/8x7-1/2	137x191	3-5/16x4-7/16	84x113	4-3/4	121	1-7/16	37	Centered			RC-1680 ^{5,18}		
		5-7/16x7-7/16	138x189	3-1/4x4-7/16	83x113	4-13/16	122	1-7/16	37	Centered			RC-70002 ²⁴		
		5-7/16x7-7/16	138x189	3-1/4x4-7/16	83x113	6-3/4	171	1-7/16	37	Centered			RC-1677 ^{18,3}		
		5-7/16x7-7/16	138x189	4-1/2x4-1/2	114x114	6-13/16	173	1-7/16	37	Centered			RC-70030 ³		
		5-7/16x7-7/16	138x189	4-1/2x4-1/2	114x114	6-7/8	175	1-7/16	37	Centered			RC-5055 ¹⁹		
4	102	5-3/8x7-1/2	137x191	3-5/16x4-1/2	84x114	8-1/16	205	1-3/8	35	Centered				RC-5126	
		5-3/4x9	146x229	4-1/2x7	114x178	4	102	1-1/2	38	Centered				RC-5148	
		5-3/4x9	146x229	4-1/2x7	114x178	7-1/2	191	1-1/2	38	Centered				RF-1040	RF-1034DK
		5-3/4x9	146x229	4-1/2x7	114x178	7-1/2	191	5/8	16	Centered				RF-1034	RF-1034DK
		6-3/4x9-1/2	171x241	5-1/2x9	140x229	8-15/16	227	1-7/8	48	Offset	1-1/2 38			RC-5102 ^{2,29}	RC-5102DK
4-1/2	114	5-7/8x5-7/8	149x149	3-1/4x4-1/2	83x114	8	203	5/8	16	Centered				RF-1021	
		6-1/4x9-1/4	159x235	4-1/2x7	114x178	10	254	5/8	16	Centered				RF-1024 ³	RF-1024DK
6	152	6-1/4x8-1/4	159x210	4x6-1/4	102x159	5	127	1	25	Centered			RC-3160		
		6-1/4x8-1/4	159x210	4-1/2x7	114x178	3-1/4	83	1	25	Centered			RF-1002		

1) 1/4-20 Jack Nut Into Top 2) Base Has (2) 7/8" Vents 3) Base Has 1/2" Vent 4) Base Has 1/32" Vent 5) Base Has 1/4" Vent 6) Base Has 11/16" Vent 7) Base Has 1-1/8" Vent 8) Base Has 13/16" Vent 9) Base Has 13/32" Vent 10) Base Has 13/64" Vent 11) Base Has 2-3/16" Square Inlet 12) Base Has 15/64" Vent 13) Base Has 19/32" Vent 14) Base Has 21/32" Vent 15) Base Has 25/64" Vent 16) Base Has 29/32" Vent 17) Base Has 3/16" Vent 18) Base Has 3/4" Vent 19) Base Has 3/8" Vent 20) Base Has 31/64" Vent 21) Base Has 35/64" Vent 22) Base Has 45/64" Vent 23) Base Has 5/16" Vent 24) Base Has 5/8" Vent 25) Base Has 55/64" Vent 26) Base Has 7/16" Vent 27) Base Has 7/8" Vent 28) Base Has 9/16" Vent 29) Base Has Opt. 1/2" Vent 30) Base Has 23/32" Vent 31) Base Has 25/32" Vent 32) Filter Has Molded-in Velocity Stack 33) Filter Is Reverse Tapered 34) Fits Legend/Dwarf Race Cars w/FJ1200 Motors 35) Base Has 15/32" Vent 36) Top Plate Has 1/4-20 Stud 37) Top-Plate Has 6MM Stud 39) Offset Is Vertical 41) Offset Is Vertical And To The Right 42) Top Has 1/2" Vent 43) Top Has 1-1/16" Center Hole 44) Top Has 21/32" Center Hole 45) Top Has 23/32" Center Hole 46) Top Has 5/32" Center Hole 47) Top Has 7/16" Center Hole 48) Base Has 11/32" Vent 49) Top Has 1/4" Center Hole 50) Top Has 1-7/16" Center Hole 51) 2-1/2" Adapter Included 52) Top Has 5/8" Vent 53) Tapered Insert Included 5" to 4-3/8" 54) Filter has Thru Hole 2-3/4" x 1-5/8"

AIR FILTER WRAPS FOR ADDED PROTECTION

DRYCHARGER® AND PRECHARGER® WRAPS - ROUND STRAIGHT

I.D.	HEIGHT	DESCRIPTION	PART#
2" (51mm)	3" (76mm)	Dry-Black	62-1300DK
2.75" (70mm)	2.813" (71mm)	Dry-Black	E-4142DK
3" (76mm)	12.5" (318mm)	Dry-Black	E-3810DK
3" (76mm)	2.5" (64mm)	Pre-Black	RU-0150PK
3" (76mm)	3" (76mm)	Pre-Black	22-8008PK
3" (76mm)	4" (102mm)	Pre-Black	22-8009PK
3" (76mm)	5" (127mm)	Pre-Black	RU-0210PK
3" (76mm)	6" (152mm)	Pre-Black	22-8010PK
3.25" (83mm)	7.063" (179mm)	Dry-Black	E-4510DK
3.25" (83mm)	2.5" (64mm)	Pre-Black	22-8007PK
3.25" (83mm)	3.5" (89mm)	Pre-Black	AC-3098PK
3.313" (84mm)	5.5" (140mm)	Pre-Black	YA-2597PK
3.5" (89mm)	1.5" (38mm)	Dry-Black	RC-0170DK
3.5" (89mm)	4" (102mm)	Pre-Black	RU-0500PK
3.5" (89mm)	5" (127mm)	Pre-Black	RU-0510PK
3.5" (89mm)	5" (127mm)	Pre-Blue	RU-0510PL
3.5" (89mm)	5" (127mm)	Pre-Red	RU-0510PR
3.5" (89mm)	5" (127mm)	Pre-Yellow	RU-0510PY
3.5" (89mm)	6" (152mm)	Pre-Black	RU-0520PK
3.625" (92mm)	9" (229mm)	Pre-Black	YA-4350PK
3.875" (98mm)	4.25" (108mm)	Pre-Red	HA-3098PR
3.875" (98mm)	4.313" (110mm)	Pre-Red	HA-2090PR
3.875" (98mm)	5.875" (149mm)	Pre-Black	YA-3504PK
3.938" (100mm)	5.625" (143mm)	Pre-Black	YA-4001PK
4" (102mm)	7" (178mm)	Dry-Black	PL-5006DK
4" (102mm)	4" (102mm)	Pre-Black	22-8011PK
4" (102mm)	4.25" (108mm)	Pre-Black	PL-1004PK
4" (102mm)	5" (127mm)	Pre-Black	RU-1460PK
4" (102mm)	6" (152mm)	Pre-Black	RU-1470PK
4" (102mm)	7" (178mm)	Pre-Black	PL-1003PK
4" (102mm)	7" (178mm)	Pre-Black	RU-1480PK
4.5" (114mm)	4" (102mm)	Dry-Black	RB-0900DK
4.5" (114mm)	3.563" (90mm)	Pre-Blue	KA-2288PL
4.5" (114mm)	3.625" (92mm)	Pre-Blue	KA-4093PL
4.5" (114mm)	4" (102mm)	Pre-Black	22-8012PK
4.5" (114mm)	5" (127mm)	Pre-Black	22-8013PK
4.5" (114mm)	6" (152mm)	Pre-Red	HA-4504PR
4.625" (117mm)	5" (127mm)	Pre-Red	HA-3094PR
4.75" (121mm)	4.625" (117mm)	Pre-Black	HA-5000PK
5" (127mm)	5" (127mm)	Dry-Black	RC-5182DK
5" (127mm)	5.5" (140mm)	Dry-Black	CM-4508DK
5" (127mm)	6.625" (168mm)	Dry-Black	KA-4508DK
5" (127mm)	7.25" (184mm)	Dry-Black	PL-8007DK
5" (127mm)	3.688" (94mm)	Pre-Yellow	SU-4250PY
5" (127mm)	4" (102mm)	Pre-Black	22-8014PK

I.D.	HEIGHT	DESCRIPTION	PART#
5" (127mm)	5" (127mm)	Pre-Black	RU-2430PK
5" (127mm)	6" (152mm)	Pre-Black	YA-4504PK
5" (127mm)	7" (178mm)	Pre-Black	22-8044PK
5.25" (133mm)	4.75" (121mm)	Dry-Black	SU-7005DK
5.25" (133mm)	6.25" (159mm)	Dry-Black	AC-1012DK
5.5" (140mm)	2.25" (57mm)	Dry-Black	E-4665DK
5.5" (140mm)	5.5" (140mm)	Dry-Black	KA-7508DK
5.5" (140mm)	3" (76mm)	Pre-Black	22-8015PK
5.5" (140mm)	5" (127mm)	Pre-Black	22-8016PK
6" (152mm)	6" (152mm)	Dry-Black	22-8045DK
6" (152mm)	1.75" (44mm)	Pre-Black	E-3211PK
6" (152mm)	1.75" (44mm)	Pre-Blue	E-3211PL
6" (152mm)	1.75" (44mm)	Pre-Red	E-3211PR
6" (152mm)	12" (305mm)	Pre-Black	22-8046PK
6" (152mm)	2" (51mm)	Pre-Black	22-8017PK
6" (152mm)	3.25" (83mm)	Pre-Black	E-3190PK
6" (152mm)	3.25" (83mm)	Pre-Blue	E-3190PL
6" (152mm)	3.25" (83mm)	Pre-Red	E-3190PR
6" (152mm)	3.25" (83mm)	Pre-Yellow	E-3190PY
6" (152mm)	3.5" (89mm)	Pre-Black	22-8018PK
6.188" (157mm)	7.563" (192mm)	Dry-Black	E-4710DK
6.25" (159mm)	1.5" (38mm)	Dry-Black	RC-3028DK
6.25" (159mm)	1.5" (38mm)	Dry-Blue	RC-3028DL
6.25" (159mm)	1.5" (38mm)	Dry-Red	RC-3028DR
6.25" (159mm)	1.5" (38mm)	Dry-Yellow	RC-3028DY
7" (178mm)	2" (51mm)	Dry-Black	E-4521DK
7" (178mm)	2.25" (57mm)	Dry-Black	E-4518DK
7" (178mm)	2" (51mm)	Pre-Black	E-3360PK
7" (178mm)	2" (51mm)	Pre-Red	E-3360PR
7" (178mm)	2" (51mm)	Pre-Yellow	E-3360PY
7" (178mm)	3" (76mm)	Pre-Black	E-3380PK
7" (178mm)	3" (76mm)	Pre-Blue	E-3380PL
7" (178mm)	3" (76mm)	Pre-Red	E-3380PR
7" (178mm)	3" (76mm)	Pre-Black	RU-0980PK
7" (178mm)	4" (102mm)	Pre-Black	22-8019PK
7" (178mm)	4" (102mm)	Pre-Black	E-2510PK
7" (178mm)	4" (102mm)	Pre-Blue	E-2510PL
7" (178mm)	4" (102mm)	Pre-Red	E-2510PR
7" (178mm)	4" (102mm)	Pre-Yellow	E-2510PY
7" (178mm)	5" (127mm)	Pre-Black	22-8020PK
7" (178mm)	6" (152mm)	Pre-Black	22-8021PK
7" (178mm)	9" (229mm)	Pre-Black	22-8022PK
7.5" (191mm)	2.25" (57mm)	Pre-Black	RK-3901PK
7.625" (194mm)	10" (254mm)	Dry-Red	RU-3270DR

DRYCHARGER® AND PRECHARGER® WRAPS - ROUND TAPERED

BASE I.D.	TOP I.D.	HEIGHT	DESC.	PART#
2.25" (57mm)	2" (51mm)	2.5" (64mm)	Pre-Black	RC-2540PK
2.5" (64mm)	2" (51mm)	2.25" (57mm)	Pre-Black	RC-0790PK
3" (76mm)	2" (51mm)	3" (76mm)	Pre-Black	22-8028PK
3" (76mm)	2" (51mm)	4" (102mm)	Pre-Black	22-8048PK
3.5" (89mm)	2" (51mm)	4" (102mm)	Pre-Black	RC-1200PK
3.75" (95mm)	2" (51mm)	5" (127mm)	Pre-Black	22-8029PK
3.875" (98mm)	3.5" (89mm)	3.813" (97mm)	Pre-Red	HA-3500PR
4" (102mm)	3.75" (95mm)	1.5" (38mm)	Dry-Black	59-2045DK
4" (102mm)	2" (51mm)	6" (152mm)	Dry-Black	22-8030DK
4.313" (110mm)	4.25" (108mm)	5.313" (135mm)	Pre-Black	KA-3603PK
4.375" (111mm)	4.5" (114mm)	4.5" (114mm)	Pre-Red	HA-2504PR
4.5" (114mm)	3.5" (89mm)	2.5" (64mm)	Dry-Red	22-2042PR
4.5" (114mm)	3" (76mm)	4" (102mm)	Dry-Blue	22-2040PL
4.5" (114mm)	3" (76mm)	4" (102mm)	Dry-Red	22-2040PR
4.5" (114mm)	3.5" (89mm)	4" (102mm)	Pre-Black	AC-4096PK

BASE I.D.	TOP I.D.	HEIGHT	DESC.	PART#
4.5" (114mm)	3.5" (89mm)	5.375" (137mm)	Pre-Black	SU-4002PK
4.5" (114mm)	4" (102mm)	6.125" (156mm)	Pre-Black	RX-3820PK
4.5" (114mm)	4" (102mm)	6.125" (156mm)	Pre-Red	RX-3820PR
4.5" (114mm)	4" (102mm)	6.5" (165mm)	Pre-Black	22-8031PK
4.625" (117mm)	3.75" (95mm)	3.438" (87mm)	Pre-Black	22-8088PK
4.625" (117mm)	3.5" (89mm)	6.75" (171mm)	Pre-Black	YA-3502PK
4.688" (119mm)	3.5" (89mm)	4.875" (124mm)	Dry-Black	RC-9350DK
4.688" (119mm)	3.5" (89mm)	4.875" (124mm)	Dry-Blue	RC-9350DL
4.688" (119mm)	3.5" (89mm)	4.875" (124mm)	Dry-Red	RC-9350DR
4.688" (119mm)	3.5" (89mm)	4.875" (124mm)	Dry-Yellow	RC-9350DY
4.75" (121mm)	4.5" (114mm)	4.75" (121mm)	Dry-Black	HA-6806DK
4.75" (121mm)	3.5" (89mm)	5.875" (149mm)	Dry-Black	RC-9310DK
4.75" (121mm)	3.5" (89mm)	7" (178mm)	Dry-Black	RU-3130DK
4.75" (121mm)	3.5" (89mm)	6" (152mm)	Pre-Red	HA-4250PR
5" (127mm)	4" (102mm)	6" (152mm)	Dry-Black	PL-5207DK

AIR FILTER WRAPS FOR ADDED PROTECTION

DRYCHARGER® AND PRECHARGER® WRAPS - ROUND TAPERED CONTINUED

BASE I.D.	TOP I.D.	HEIGHT	DESC.	PART#
5" (127mm)	4" (102mm)	6" (152mm)	Dry-Black	RC-4650DK
5" (127mm)	4" (102mm)	6" (152mm)	Dry-Blue	RC-4650DL
5" (127mm)	4" (102mm)	6" (152mm)	Dry-Red	RC-4650DR
5" (127mm)	4" (102mm)	6" (152mm)	Dry-Yellow	RC-4650DY
5" (127mm)	4" (102mm)	7.875" (200mm)	Dry-Black	RC-4690DK
5" (127mm)	4" (102mm)	7.875" (200mm)	Dry-Blue	RC-4690DL
5" (127mm)	4" (102mm)	7.875" (200mm)	Dry-Red	RC-4690DR
5" (127mm)	4" (102mm)	7.875" (200mm)	Dry-Yellow	RC-4690DY
5" (127mm)	4.5" (114mm)	4.5" (114mm)	Pre-Red	HA-4400PR
5" (127mm)	4" (102mm)	7" (178mm)	Pre-Black	22-2030PK
5" (127mm)	4.75" (121mm)	8" (203mm)	Pre-Black	RE-0910PK
5.125" (130mm)	3.5" (89mm)	6" (152mm)	Dry-Black	RC-4160DK
5.125" (130mm)	4.5" (114mm)	4.188" (106mm)	Pre-Red	HA-3093PR
5.25" (133mm)	3" (76mm)	6" (152mm)	Dry-Blue	22-2030PL
5.25" (133mm)	3" (76mm)	6" (152mm)	Dry-Red	22-2030PR
5.375" (137mm)	4" (102mm)	5.5" (140mm)	Dry-Black	RP-4660DK
5.375" (137mm)	4" (102mm)	5.5" (140mm)	Dry-Blue	RP-4660DL
5.375" (137mm)	4" (102mm)	5.5" (140mm)	Dry-Red	RP-4660DR
5.375" (137mm)	4" (102mm)	5.5" (140mm)	Dry-Yellow	RP-4660DY
5.375" (137mm)	4" (102mm)	6.5" (165mm)	Dry-Black	RC-5149DK
5.375" (137mm)	4.375" (111mm)	7" (178mm)	Dry-Black	RU-2590DK
5.375" (137mm)	4.375" (111mm)	3.5" (89mm)	Pre-Red	HA-2440PR
5.5" (140mm)	4.5" (114mm)	6.5" (165mm)	Dry-Black	RC-4630DK
5.5" (140mm)	4.5" (114mm)	6.5" (165mm)	Dry-Blue	RC-4630DL
5.5" (140mm)	4.5" (114mm)	6.5" (165mm)	Dry-Red	RC-4630DR
5.5" (140mm)	4.5" (114mm)	6.5" (165mm)	Dry-Yellow	RC-4630DY
5.5" (140mm)	4" (102mm)	8" (203mm)	Dry-Black	RF-1045DK
5.5" (140mm)	4" (102mm)	8" (203mm)	Dry-Blue	RF-1045DL
5.5" (140mm)	4" (102mm)	8" (203mm)	Dry-Red	RF-1045DR
5.5" (140mm)	4" (102mm)	8" (203mm)	Dry-Yellow	RF-1045DY
5.75" (146mm)	4.5" (114mm)	6" (152mm)	Dry-Black	RF-1023DK
5.75" (146mm)	4.5" (114mm)	6" (152mm)	Dry-Blue	RF-1023DL
5.75" (146mm)	4.5" (114mm)	6" (152mm)	Dry-Red	RF-1023DR
5.75" (146mm)	3.5" (89mm)	6" (152mm)	Dry-Black	RF-1035DK
5.75" (146mm)	3.5" (89mm)	6" (152mm)	Dry-Blue	RF-1035DL
5.75" (146mm)	3.5" (89mm)	6" (152mm)	Dry-Red	RF-1035DR
5.75" (146mm)	3.5" (89mm)	6" (152mm)	Dry-Yellow	RF-1035DY
5.813" (148mm)	4" (102mm)	6" (152mm)	Dry-Black	RU-5168DK
5.875" (149mm)	4.938" (125mm)	4" (102mm)	Pre-Yellow	SU-5098PY
5.875" (149mm)	5" (127mm)	6" (152mm)	Pre-Black	RU-3480PK
6" (152mm)	5" (127mm)	5.563" (141mm)	Dry-Black	RX-4990DK
6" (152mm)	5" (127mm)	5.563" (141mm)	Dry-Blue	RX-4990DL
6" (152mm)	5" (127mm)	5.563" (141mm)	Dry-Red	RX-4990DR
6" (152mm)	5" (127mm)	5.563" (141mm)	Dry-Yellow	RX-4990DY
6" (152mm)	5" (127mm)	6.5" (165mm)	Dry-Black	RX-4730DK
6" (152mm)	5" (127mm)	6.5" (165mm)	Dry-Blue	RX-4730DL
6" (152mm)	5" (127mm)	6.5" (165mm)	Dry-Red	RX-4730DR
6" (152mm)	5" (127mm)	6.5" (165mm)	Dry-Yellow	RX-4730DY
6" (152mm)	4" (102mm)	6.75" (171mm)	Dry-Black	RC-4700DK
6" (152mm)	4" (102mm)	6.75" (171mm)	Dry-Blue	RC-4700DL
6" (152mm)	4" (102mm)	6.75" (171mm)	Dry-Red	RC-4700DR
6" (152mm)	4" (102mm)	6.75" (171mm)	Dry-Yellow	RC-4700DY
6" (152mm)	5" (127mm)	7" (178mm)	Dry-Black	RC-5100DK
6" (152mm)	5" (127mm)	7" (178mm)	Dry-Blue	RC-5100DL
6" (152mm)	5" (127mm)	7" (178mm)	Dry-Red	RC-5100DR
6" (152mm)	5" (127mm)	7" (178mm)	Dry-Yellow	RC-5100DY
6" (152mm)	4.5" (114mm)	7" (178mm)	Dry-Black	RF-1015DK
6" (152mm)	4.5" (114mm)	7" (178mm)	Dry-Blue	RF-1015DL
6" (152mm)	4.5" (114mm)	7" (178mm)	Dry-Red	RF-1015DR
6" (152mm)	4.5" (114mm)	7" (178mm)	Dry-Yellow	RF-1015DY
6" (152mm)	4.5" (114mm)	8" (203mm)	Dry-Black	RC-5106DK
6" (152mm)	4.5" (114mm)	8" (203mm)	Dry-Blue	RC-5106DL
6" (152mm)	4.5" (114mm)	8" (203mm)	Dry-Red	RC-5106DR
6" (152mm)	4.5" (114mm)	8" (203mm)	Dry-Yellow	RC-5106DY

BASE I.D.	TOP I.D.	HEIGHT	DESC.	PART#
6" (152mm)	4.5" (114mm)	9" (229mm)	Dry-Black	RC-3690DK
6" (152mm)	4.5" (114mm)	9" (229mm)	Dry-Blue	RC-3690DL
6" (152mm)	4.5" (114mm)	9" (229mm)	Dry-Red	RC-3690DR
6" (152mm)	4.5" (114mm)	9" (229mm)	Dry-Yellow	RC-3690DY
6" (152mm)	4.625" (117mm)	12" (305mm)	Pre-Black	22-8034PK
6" (152mm)	4.625" (117mm)	14" (356mm)	Pre-Black	22-8035PK
6" (152mm)	4.625" (117mm)	6" (152mm)	Pre-Black	22-8033PK
6" (152mm)	4.625" (117mm)	9" (229mm)	Pre-Black	RE-0810PK
6.125" (156mm)	5.125" (130mm)	3.938" (100mm)	Dry-Black	SU-4506DK
6.25" (159mm)	5.5" (140mm)	2.125" (54mm)	Dry-Black	HD-0800DK
6.25" (159mm)	4.375" (111mm)	4.125" (105mm)	Dry-Black	RU-5163DK
6.313" (160mm)	5.438" (138mm)	3" (76mm)	Pre-Black	SU-4000PK
6.5" (165mm)	4.5" (114mm)	5.5" (140mm)	Dry-Black	RU-5147DK
6.5" (165mm)	4.5" (114mm)	6" (152mm)	Dry-Black	RC-5060DK
6.5" (165mm)	4.5" (114mm)	6" (152mm)	Dry-Blue	RC-5060DL
6.5" (165mm)	4.5" (114mm)	6" (152mm)	Dry-Red	RC-5060DR
6.5" (165mm)	4.5" (114mm)	6" (152mm)	Dry-Yellow	RC-5060DY
6.5" (165mm)	5" (127mm)	6.5" (165mm)	Dry-Black	RF-1037DK
6.5" (165mm)	5" (127mm)	6.5" (165mm)	Dry-Blue	RF-1037DL
6.5" (165mm)	5" (127mm)	6.5" (165mm)	Dry-Red	RF-1037DR
6.5" (165mm)	5" (127mm)	6.5" (165mm)	Dry-Yellow	RF-1037DY
6.5" (165mm)	4.5" (114mm)	7" (178mm)	Dry-Black	RF-1032DK
6.5" (165mm)	4.5" (114mm)	7" (178mm)	Dry-Blue	RF-1032DL
6.5" (165mm)	4.5" (114mm)	7" (178mm)	Dry-Red	RF-1032DR
6.5" (165mm)	4.5" (114mm)	7" (178mm)	Dry-Yellow	RF-1032DY
6.5" (165mm)	4.5" (114mm)	8" (203mm)	Dry-Black	RF-1027DK
6.5" (165mm)	4.5" (114mm)	8" (203mm)	Dry-Blue	RF-1027DL
6.5" (165mm)	4.5" (114mm)	8" (203mm)	Dry-Red	RF-1027DR
6.5" (165mm)	4.5" (114mm)	8" (203mm)	Dry-Yellow	RF-1027DY
6.625" (168mm)	5.25" (133mm)	9.5" (241mm)	Dry-Black	RC-4780DK
6.625" (168mm)	6.25" (159mm)	9.5" (241mm)	Dry-Blue	RC-4780DL
6.625" (168mm)	5.25" (133mm)	9.5" (241mm)	Dry-Red	RC-4780DR
6.625" (168mm)	5.25" (133mm)	9.5" (241mm)	Dry-Yellow	RC-4780DY
6.75" (171mm)	5.875" (149mm)	9.5" (241mm)	Dry-Black	RU-5045DK
7" (178mm)	3.75" (95mm)	1" (25mm)	Dry-Black	E-2435DK
7.375" (187mm)	6.625" (168mm)	7.875" (200mm)	Dry-Black	RC-4900DK
7.375" (187mm)	6.625" (168mm)	7.875" (200mm)	Dry-Blue	RC-4900DL
7.375" (187mm)	6.625" (168mm)	7.875" (200mm)	Dry-Red	RC-4900DR
7.375" (187mm)	6.625" (168mm)	7.875" (200mm)	Dry-Yellow	RC-4900DY
7.5" (191mm)	7" (178mm)	11" (279mm)	Dry-Black	RF-1026DK
7.5" (191mm)	7" (178mm)	11" (279mm)	Dry-Blue	RF-1026DL
7.5" (191mm)	7" (178mm)	11" (279mm)	Dry-Red	RF-1026DR
7.5" (191mm)	7" (178mm)	18" (457mm)	Dry-Black	RC-3070DK
7.5" (191mm)	5.875" (149mm)	3" (76mm)	Dry-Black	RF-1028DK
7.5" (191mm)	5.875" (149mm)	3" (76mm)	Dry-Blue	RF-1028DL
7.5" (191mm)	5.875" (149mm)	3" (76mm)	Dry-Red	RF-1028DR
7.5" (191mm)	5.875" (149mm)	3" (76mm)	Dry-Yellow	RF-1028DY
7.5" (191mm)	5" (127mm)	4" (102mm)	Dry-Black	RF-1009DK
7.5" (191mm)	5" (127mm)	4" (102mm)	Dry-Blue	RF-1009DL
7.5" (191mm)	5" (127mm)	4" (102mm)	Dry-Red	RF-1009DR
7.5" (191mm)	5" (127mm)	4" (102mm)	Dry-Yellow	RF-1009DY
7.5" (191mm)	5" (127mm)	5" (127mm)	Dry-Black	22-8049DK
7.5" (191mm)	5.875" (149mm)	6" (152mm)	Dry-Black	RC-5173DK
7.5" (191mm)	5" (127mm)	6" (152mm)	Dry-Black	RF-1036DK
7.5" (191mm)	5" (127mm)	6" (152mm)	Dry-Blue	RF-1036DL
7.5" (191mm)	5" (127mm)	6" (152mm)	Dry-Yellow	RF-1036DY
7.5" (191mm)	4.5" (114mm)	6" (152mm)	Dry-Black	RF-1048DK
7.5" (191mm)	4.5" (114mm)	6" (152mm)	Dry-Blue	RF-1048DL
7.5" (191mm)	4.5" (114mm)	6" (152mm)	Dry-Red	RF-1048DR
7.5" (191mm)	4.5" (114mm)	6" (152mm)	Dry-Yellow	RF-1048DY
7.5" (191mm)	4.5" (114mm)	6.5" (165mm)	Dry-Black	RC-5107DK
7.5" (191mm)	4.5" (114mm)	6.5" (165mm)	Dry-Blue	RC-5107DL
7.5" (191mm)	4.5" (114mm)	6.5" (165mm)	Dry-Red	RC-5107DR
7.5" (191mm)	4.5" (114mm)	6.5" (165mm)	Dry-Yellow	RC-5107DY

AMERICAN V-TWIN

STREET

OFF-ROAD

WATERRAFT/SNOW

SPECIALTY/ACCESSORIES

HAULER HORSEPOWER

APPAREL/SIGNAGE

K&N®

AIR FILTER WRAPS FOR ADDED PROTECTION

DRYCHARGER® AND PRECHARGER® WRAPS - ROUND TAPERED CONTINUED

BASE I.D.	TOP I.D.	HEIGHT	DESC.	PART#
7.5" (191mm)	5.875" (149mm)	6.5" (165mm)	Dry-Black	RF-1014DK
7.5" (191mm)	5.875" (149mm)	6.5" (165mm)	Dry-Blue	RF-1014DL
7.5" (191mm)	5.875" (149mm)	6.5" (165mm)	Dry-Red	RF-1014DR
7.5" (191mm)	5.875" (149mm)	6.5" (165mm)	Dry-Yellow	RF-1014DY
7.5" (191mm)	5" (127mm)	6.5" (165mm)	Dry-Black	RF-1042DK
7.5" (191mm)	5" (127mm)	6.5" (165mm)	Dry-Blue	RF-1042DL
7.5" (191mm)	5" (127mm)	6.5" (165mm)	Dry-Red	RF-1042DR
7.5" (191mm)	5" (127mm)	6.5" (165mm)	Dry-Yellow	RF-1042DY
7.5" (191mm)	5.125" (130mm)	7" (178mm)	Dry-Black	RF-1029DK
7.5" (191mm)	5.125" (130mm)	7" (178mm)	Dry-Blue	RF-1029DL
7.5" (191mm)	5.125" (130mm)	7" (178mm)	Dry-Red	RF-1029DR
7.5" (191mm)	5.125" (130mm)	7" (178mm)	Dry-Yellow	RF-1029DY
7.5" (191mm)	5" (127mm)	7.5" (191mm)	Dry-Black	RF-1041DK
7.5" (191mm)	5" (127mm)	7.5" (191mm)	Dry-Blue	RF-1041DL
7.5" (191mm)	5" (127mm)	7.5" (191mm)	Dry-Red	RF-1041DR
7.5" (191mm)	5" (127mm)	7.5" (191mm)	Dry-Yellow	RF-1041DY
7.5" (191mm)	5" (127mm)	8" (203mm)	Dry-Black	22-8038DK

BASE I.D.	TOP I.D.	HEIGHT	DESC.	PART#
7.5" (191mm)	7" (178mm)	8" (203mm)	Dry-Black	RF-1017DK
7.5" (191mm)	7" (178mm)	8" (203mm)	Dry-Blue	RF-1017DL
7.5" (191mm)	7" (178mm)	8" (203mm)	Dry-Red	RF-1017DR
7.5" (191mm)	7" (178mm)	8" (203mm)	Dry-Yellow	RF-1017DY
7.5" (191mm)	5" (127mm)	8" (203mm)	Dry-Black	RF-1020DK
7.5" (191mm)	5" (127mm)	8" (203mm)	Dry-Red	RF-1020DR
7.5" (191mm)	5.875" (149mm)	8.5" (216mm)	Dry-Blue	RF-1020DL
7.5" (191mm)	5.875" (149mm)	8.5" (216mm)	Dry-Yellow	RF-1020DY
7.5" (191mm)	4.5" (114mm)	9" (229mm)	Dry-Black	RC-5046DK
7.5" (191mm)	4.5" (114mm)	9" (229mm)	Dry-Blue	RC-5046DL
7.5" (191mm)	4.5" (114mm)	9" (229mm)	Dry-Red	RC-5046DR
7.5" (191mm)	4.5" (114mm)	9" (229mm)	Dry-Yellow	RC-5046DY
7.5" (191mm)	5" (127mm)	4" (102mm)	Pre-Black	22-8036PK
7.5" (191mm)	7" (178mm)	8" (203mm)	Pre-Black	22-8050PK
8" (203mm)	6.625" (168mm)	10.5" (267mm)	Dry-Black	RC-5166DK
8" (203mm)	7" (178mm)	13" (330mm)	Dry-Black	RC-5165DK
8" (203mm)	6.625" (168mm)	8" (203mm)	Dry-Black	RC-5112DK

DRYCHARGER® AND PRECHARGER® WRAPS - OVAL TAPERED

BASE" SIDE LENGTH	BASE" SIDE WIDTH	TOP" SIDE LENGTH	TOP" SIDE WIDTH	HEIGHT	DESC.	PART#
3" (76mm)	3.75" (95mm)	3" (76mm)	2" (51mm)	6" (152mm)	Dry-Black	RC-3680DK
4" (102mm)	3" (76mm)	3" (76mm)	2" (51mm)	2.75" (70mm)	Dry-Black	RC-1820DK
4" (102mm)	3" (76mm)	3.5" (89mm)	2.5" (64mm)	2.75" (70mm)	Dry-Black	RU-0981DK
4" (102mm)	3" (76mm)	3" (76mm)	2" (51mm)	4" (102mm)	Dry-Black	RC-2890DK
4" (102mm)	3.25" (83mm)	3.5" (89mm)	2.5" (64mm)	7" (178mm)	Dry-Black	SN-2560DK
4.5" (114mm)	3.75" (95mm)	3.5" (89mm)	2.5" (64mm)	2.75" (70mm)	Dry-Black	RU-2780DK
5.625" (143mm)	4.125" (105mm)	4.5" (114mm)	3.25" (83mm)	2.5" (64mm)	Pre-Blue	KA-6589PL
6" (152mm)	3.75" (95mm)	4.25" (108mm)	3.25" (83mm)	5" (127mm)	Pre-Black	RU-4720PK
6.25" (159mm)	3.75" (95mm)	4.5" (114mm)	3.5" (89mm)	6.75" (171mm)	Pre-Black	RU-4710PK
6.375" (162mm)	4.75" (121mm)	4.5" (114mm)	3.25" (83mm)	2.75" (70mm)	Pre-Black	YA-2088PK
6.5" (165mm)	4.5" (114mm)	9" (229mm)	5.5" (140mm)	6.25" (159mm)	Pre-Black	RD-4200PK
6.5" (165mm)	4.5" (114mm)	9" (229mm)	5.5" (140mm)	6.25" (159mm)	Pre-Blue	RD-4200PL
6.5" (165mm)	4.5" (114mm)	9" (229mm)	5.5" (140mm)	6.25" (159mm)	Pre-Red	RD-4200PR
6.5" (165mm)	4.5" (114mm)	9" (229mm)	5.5" (140mm)	6.25" (159mm)	Pre-Yellow	RD-4200PY
7" (178mm)	4.5" (114mm)	6.25" (159mm)	4" (102mm)	3" (76mm)	Dry-Blue	22-2015PL
7" (178mm)	4.5" (114mm)	6.25" (159mm)	4" (102mm)	3" (76mm)	Dry-Red	22-2015PR
7" (178mm)	5.5" (140mm)	5.25" (133mm)	4.25" (108mm)	5" (127mm)	Dry-Black	RC-70031DK
7.75" (197mm)	5.5" (140mm)	6.25" (159mm)	4" (102mm)	5" (127mm)	Dry-Black	RF-1001DK
7.75" (197mm)	5.5" (140mm)	6.25" (159mm)	4" (102mm)	5" (127mm)	Dry-Blue	RF-1001DL
7.75" (197mm)	5.5" (140mm)	6.25" (159mm)	4" (102mm)	5" (127mm)	Dry-Red	RF-1001DR
7.75" (197mm)	5.5" (140mm)	6.25" (159mm)	4" (102mm)	5" (127mm)	Dry-Yellow	RF-1001DY

DRYCHARGER® AND PRECHARGER® WRAPS - OVAL STRAIGHT

INSIDE LENGTH	INSIDE WIDTH	HEIGHT	DESC.	PART#	INSIDE LENGTH	INSIDE WIDTH	HEIGHT	DESC.	PART#
4" (102mm)	3" (76mm)	2" (51mm)	Dry-Black	E-4515DK	7" (178mm)	4.5" (114mm)	2" (51mm)	Pre-Blue	E-3321PL
4" (102mm)	3" (76mm)	2.75" (70mm)	Dry-Black	E-4516DK	7" (178mm)	4.5" (114mm)	2" (51mm)	Pre-Red	E-3321PR
4.5" (114mm)	3.75" (95mm)	6" (152mm)	Pre-Black	RU-1230PK	7" (178mm)	4.5" (114mm)	2" (51mm)	Pre-Yellow	E-3321PY
4.5" (114mm)	3.75" (95mm)	7" (178mm)	Pre-Black	RU-1240PK	7" (178mm)	4.5" (114mm)	2.25" (57mm)	Pre-Black	RK-3902PK
4.5" (114mm)	3.75" (95mm)	9" (229mm)	Pre-Black	RU-1260PK	7" (178mm)	4.5" (114mm)	3.5" (89mm)	Pre-Black	E-3341PK
6.5" (165mm)	4.625" (117mm)	7.875" (200mm)	Dry-Black	YA-7008DK	7" (178mm)	4.5" (114mm)	3.5" (89mm)	Pre-Blue	E-3341PL
6.625" (168mm)	4.625" (117mm)	2.875" (73mm)	Pre-Yellow	SU-6590PY	7" (178mm)	4.5" (114mm)	3.5" (89mm)	Pre-Red	E-3341PR
6.625" (168mm)	3.813" (97mm)	3.438" (87mm)	Pre-Black	PL-1002PK	7" (178mm)	4.5" (114mm)	3.5" (89mm)	Pre-Yellow	E-3341PY
7" (178mm)	4.5" (114mm)	2" (51mm)	Dry-Blue	22-2000PL	7.375" (187mm)	4" (102mm)	2.063" (52mm)	Pre-Red	HA-1312PR
7" (178mm)	4.5" (114mm)	2" (51mm)	Dry-Red	22-2000PR	7.375" (187mm)	4" (102mm)	2.563" (65mm)	Pre-Red	HA-1315PR
7" (178mm)	4.5" (114mm)	3" (76mm)	Dry-Blue	22-2020PL	7.5" (191mm)	5.5" (140mm)	4.75" (121mm)	Dry-Black	KA-7408DK
7" (178mm)	4.5" (114mm)	3" (76mm)	Dry-Red	22-2020PR	7.75" (197mm)	4.75" (121mm)	2.5" (64mm)	Pre-Red	HA-6592PR
7" (178mm)	4.5" (114mm)	2" (51mm)	Pre-Black	E-3321PK	7.75" (197mm)	5.875" (149mm)	5.063" (129mm)	Pre-Black	KA-7504PK

AIR FILTER WRAPS FOR ADDED PROTECTION

DRYCHARGER® AND PRECHARGER® WRAPS - ROUND REVERSE TAPERED

BASE I.D.	TOP I.D.	HEIGHT	DESC.	PART#	BASE I.D.	TOP I.D.	HEIGHT	DESC.	PART#
3.375" (86mm)	3.5" (89mm)	4.125" (105mm)	Pre-Black	SU-2504PK	4.5" (114mm)	6" (152mm)	6.125" (156mm)	Dry-Black	RX-3810DK
3.813" (97mm)	3.875" (98mm)	8.125" (206mm)	Pre-Black	YA-6504PK	4.5" (114mm)	6" (152mm)	6.125" (156mm)	Dry-Red	RX-3810DR
4.5" (114mm)	6" (152mm)	6.125" (156mm)	Dry-Black	RX-3810DK	6.25" (159mm)	7" (178mm)	3.625" (92mm)	Dry-Black	HD-0700DK

DRYCHARGER® AND PRECHARGER® WRAPS - UNIQUE SHAPES

DESCRIPTION	PART#	DESCRIPTION	PART#
Dry-Black	SU-6596DK	Dry-Black	KT-5201DK
Dry-Black	HA-2591DK	Dry-Black	RC-5052DK
Dry-Black	HA-4503DK	Dry-Black	YA-4098-1DK
Dry-Black	KA-4408DK	Dry-Black	YA-4503DK
Pre-Black	KA-6503PK	Dry-Black	YA-6601DK

DRYCHARGER® AND PRECHARGER® WRAPS - UNIVERSAL USE

LENGTH	WIDTH	DESC.	PART#	LENGTH	WIDTH	DESC.	PART#
7" (178mm)	7" (178mm)	Dry-Black	SU-4002-TDK	9.75" (248mm)	5.75" (146mm)	Dry-Black	YA-3502-TDK
7.125" (181mm)	7.125" (181mm)	Dry-Black	YA-4504-TDK	9.875" (251mm)	7.125" (181mm)	Dry-Black	HA-4504-TDK
8.25" (210mm)	6.75" (171mm)	Dry-Black	HA-4099-TDK	10.25" (260mm)	6.875" (175mm)	Dry-Black	YA-6601-TDK
8.25" (210mm)	6.75" (171mm)	Pre-Black	HA-4099-TPK	58" (1473mm)	36" (914mm)	Dry-Black	25-3901

PRE-CLEANER WRAPS

PART NUMBER
25-1691

ROUND TAPERED

DESCRIPTION	BASE I.D.	TOP I.D.	HEIGHT	PART#
Pre-Cleaner-Yellow	3.125" (79 mm)	3" (76 mm)	3.375" (86 mm)	25-2588
Pre-Cleaner-Red	6" (152 mm)	5" (127 mm)	14" (356 mm)	25-0880
Pre-Cleaner-Red	6" (152 mm)	5" (127 mm)	9" (229 mm)	25-0810
Pre-Cleaner-Red	7" (178 mm)	4.5" (114 mm)	4.875" (124 mm)	25-6601
Pre-Cleaner-Charcoal-Dry	8" (203 mm)	6.625" (168 mm)	12" (305 mm)	25-5166



OVAL STRAIGHT

DESCRIPTION	INSIDE LENGTH	INSIDE WIDTH	HEIGHT	PART#
Pre-Cleaner-Red	4.5" (114 mm)	3.25" (83 mm)	1.5" (38 mm)	25-4250
Pre-Cleaner-Red	5.5" (140 mm)	4.25" (108 mm)	2" (51 mm)	25-1691
Pre-Cleaner-Red	7" (178 mm)	4.5" (114 mm)	3.25" (83 mm)	25-3340
Pre-Cleaner-Red	7" (178 mm)	4.5" (114 mm)	6" (152 mm)	25-3346

UNIQUE

DESCRIPTION	PART#
Pre-Cleaner-Red	25-2587

UNIVERSAL

DESCRIPTION	WIDTH	LENGTH	PART#
Pre-Cleaner-Red	7" (178 mm)	48" (1219 mm)	25-3900
Pre-Cleaner-Red	18" (457 mm)	48" (1219 mm)	25-3918
Pre-Cleaner-Red	24" (610 mm)	48" (1219 mm)	25-3924
Pre-Cleaner-Red	30" (762 mm)	48" (1219 mm)	25-3930

PART NUMBER
25-3900



AIR FILTER CLEANING

RECHARGE YOUR K&N® AIR FILTER

SERVICING YOUR K&N® AIR FILTER IS SIMPLE - JUST FOLLOW THE 4 EASY STEPS BELOW

STEP 1: APPLY CLEANER

Liberally spray K&N® air filter cleaner or K&N® Power Kleen® onto both sides of filter and allow to soak for 10 minutes to loosen the dirt. Do not allow cleaner to dry on air filter.



STEP 2: RINSE FILTER

Rinse off air filter with cool low-pressure water from the clean side out in order to flush the dirt out of the filter. Continue to rinse the filter until all traces of cleaner are gone. It may be necessary to repeat steps 1 and 2.



STEP 3: DRY FILTER

After rinsing, gently shake off excess water and allow filter to dry naturally. Do not oil until the filter is dry.

STEP 4: OIL FILTER

SQUEEZE OIL (99-5050): Apply K&N® air filter oil evenly along the crown of each filter pleat. Allow oil to wick for approximately 20 minutes. Touch up any light areas on either side of the filter until there is a uniform red color on all areas.



AEROSOL OIL (99-5000): Spray K&N® air filter oil evenly along the crown of each filter pleat holding nozzle about 3" away. Allow oil to wick for approximately 20 minutes. Touch up any light areas on either side of the filter until there is a uniform red color on all areas.



The above process is the only approved procedure for maintaining your oiled cotton K&N® air filter. Visit knfilters.com for additional information on cleaning and re-oiling your filter and examples of a dirty filter needing to be serviced.

CLEANING SUPPLIES

RECHARGE YOUR K&N® AIR FILTER



POWER KLEEN® CLEANER/DEGREASER

K&N® Power Kleen® is the only cleaner recommended to clean K&N® air filter elements. The use of any other cleaning solution can void the filter's warranty, and quite possibly could damage your engine and the filter's cotton material. K&N® Power Kleen® works to dissolve dirt build up and old filter oil and can be washed away with water. It is now formulated to clean those troublesome and demanding cleaning jobs around your garage as well. It is environmentally friendly and specially formulated to remove oil, lubricants, grease, grime, and other deposits from most surfaces including cotton air filters, painted surfaces, chrome, plastic and more!

K&N® POWER KLEEN® INDUSTRIAL STRENGTH CLEANER	PART#
32 oz. trigger sprayer	99-0621
1 gallon bottle with trigger sprayer	99-0635
12 fl. oz. squirt bottle	99-0606
5 gallon pail	99-0640



PART NUMBER
99-0640

PART NUMBER
99-5000

PART NUMBER
99-5050

PART NUMBER
99-0606

PART NUMBER
99-0504

PART NUMBER
99-0533

PART NUMBER
99-0635

PART NUMBER
99-0621

RECHARGER® FILTER SERVICE KIT (AEROSOL)

Designed to recharge any K&N® oiled cotton air filter. It restores airflow efficiency so your air filter performs virtually like new!

6 1/2 oz. spray oil, 12 oz. filter cleaner and service decal **99-5000**

DRYFLOW® AIR FILTER CLEANER

Specially formulated cleaner to be used on K&N® heavy duty commercial grade air filters and NEW Blackhawk Induction™ intake system air filters.

32 oz. trigger sprayer **99-0624**
1 gallon bottle with 38-inch hose & spray nozzle **99-0638**

FILTER SEALING GREASE

K&N® air filter sealing grease provides an air tight fit around sealing surfaces on all types of air filter elements. It resists heat and will not melt or run off. **(not to be used on clamp-on filter elements)**

6 oz. squeeze tube **99-0704**
1 oz. squeeze tube **99-0703-1**

RECHARGER® FILTER SERVICE KIT (SQUEEZE)

Same as 99-5000 except has squeeze oil bottle instead of spray can.

8 oz. squeeze oil, 12 oz. filter cleaner and service decal **99-5050**

AIR FILTER OIL

K&N® air filter oil is the only oil specially formulated to work in combination with the cotton fabric in K&N® air filter elements providing outstanding air filtration. When used as directed, it quickly penetrates the filter pleats, where it remains suspended in the cotton fabric until the element is cleaned with K&N® air filter cleaner.

6 1/2 oz. aerosol can **99-0504**
12 oz. aerosol can **99-0516**
8 oz. squeeze bottle **99-0533**
1/2 oz. pillow pack **99-11312**
1 gallon refill bottle **99-0551**
5 gallon pail **99-0555**

CHAMPIONSHIP PERFORMANCE



**CONGRATULATIONS TO CHAD WIENEN ON HIS
5TH CONSECUTIVE WORLD CHAMPIONSHIP!**

CORPORATE HQ

K&N Engineering, Inc.
1455 Citrus Street
Riverside, CA 92507
P.O. Box 1329
Riverside, CA 92502-1329
Phone: 1-800-858-3333
Fax: 951-826-4001

UK SALES

K&N Filters Ltd.
John Street
Warrington
Cheshire, England
WA2 7UB
Phone: 44-1925-636-950
Fax: 44-1925-418-948

EUROPEAN OFFICE

SRM BV
(Subsidiary of K&N Engineering, Inc.)
Verdunplein 6
5627 SZ Eindhoven
The Netherlands
Phone: 31 (0) 40-256-8678
Fax: 31 (0) 40-256-7687

Follow us @knfilters



KNFILTERS.COM